



Table of Contents

1	Important and general information	3
1.1	Important information	3
1.1.1	Safety and Warning instructions	3
1.2	Terms and conditions	4
1.2.1	Legend of used icons	4
1.2.2	Support	4
2	PlugIn Overview	5
2.1	PlugIn description	5
2.2	PlugIn installation	5
3	PlugIn configuration	6
3.1	Functional architecture	6
3.2	Detecting interface hardware	7
3.3	LIN interface configuration	8
3.3.1	LDF import	9
3.3.2	Sending LIN messages	10

1 Important and general information

1.1 Important information

Please follow these instructions before and during the use and application on any IPETRONIK product!

1.1.1 Safety and Warning instructions

Please follow the instructions **and** information as contained in the user manual!

1. The user can **influence an electronic system by applying the IPETRONIK product**. This might cause risk of personal injury or property damages.
2. The **use and application of the IPETRONIK product is permitted only to qualified professional staff**, as well as, only in appropriate manner and in the designated use.
3. **Before using an IPETRONIK measurement system in the vehicle it has to be verified that no function of the vehicle, which is relevant for secure operation, might be influenced:**
 - by the installation of the IPETRONIK measurement system in the vehicle,
 - by an potential malfunction of the IPETRONIK system during the test drive.

In order to avoid possible danger or personal injury and property damages, appropriate actions are to be taken; such actions have to bring the entire system into a secured condition (e.g. by using a system for emergency stop, an emergency operation, monitoring of critical values).

Please check the following points to avoid errors:

- Adaption of sensors to components of the electrical system / electronics, brake system, engine and transmission control, chassis, body.
- Tap of one or several bus systems (CAN, LIN, ETHERNET) including the required electrical connection(s) for data acquisition.
- Communication with the vehicle's control units (ECUs), especially with such of the brake system and/or of the engine and transmission control (power train control system).
- Installation of components for remote data transmission (mobiles, GSM/GPRS modems, WiFi and Bluetooth components).



The products can be operated in extended temperature ranges greater 70 °C and therefore the operator has to take safety measures to avoid any skin burnings on hot surfaces while touching the products.

4. **Before** directly or indirectly using **the data acquired by an IPETRONIK measurement system to calibrate control units, please review the data regarding to plausibility.**
5. With regard to the application of IPETRONIK products in vehicles during use on public roads the manufacturer and/or registered user of the vehicle **has to ensure that all changes/modifications have no influence concerning the license of the vehicle or its license of operation.**
6. **User does agree to the instructions and regulations as mentioned above.** In case the user does not agree with the instructions and regulations as mentioned above, he has to notify this expressly and immediately in writing to IPETRONIK before confirming the sales contract.

1.2 Terms and conditions

See IPETRONIK website for details: <https://www.ipetronik.com/>

1.2.1 Legend of used icons

**Tip**

This icon indicates a useful tip that facilitates the application of the software.

**Information**

This icon indicates additional information for a better understanding.

**Attention!**

This icon indicates important information to avoid potential error messages.

1.2.2 Support

Headquarter:**IPETRONIK GmbH & Co. KG**

Im Rollfeld 28

76532 Baden-Baden, Germany

Phone +49 7221 9922 0

Fax +49 7221 9922 100

info@ipetronik.com

www.ipetronik.com

Limited commercial partnership with its head office in Baden-Baden, registry court HRA No. 201313

IPETRONIK Verwaltungs-GmbH Baden-Baden is an individually liable society, registry court Mannheim HRB No. 202089

CEOs: A. Wocke, C. Buchholz

Technical support and product information

www.ipetronik.com

e-mail: support@ipetronik.com

2 PlugIn Overview

2.1 PlugIn description

The PLIN PlugIn is supporting only the IPEcan FD Pro interface hardware from IPETRONIK. With this CAN / LIN interface you can measure LIN bus networks and send LIN messages to the network.

2.2 PlugIn installation

In order to use the PlugIn together with IPEmotion you need to install it. The PlugIn is available for download from the IPETRONIK website: <https://www.ipetronik.com/> When you have installed the PlugIn, you need to launch the IPEmotion software. Then you need to access the application menu and open the OPTIONS. In the OPTIONS you can activate the PlugIn as indicated below.

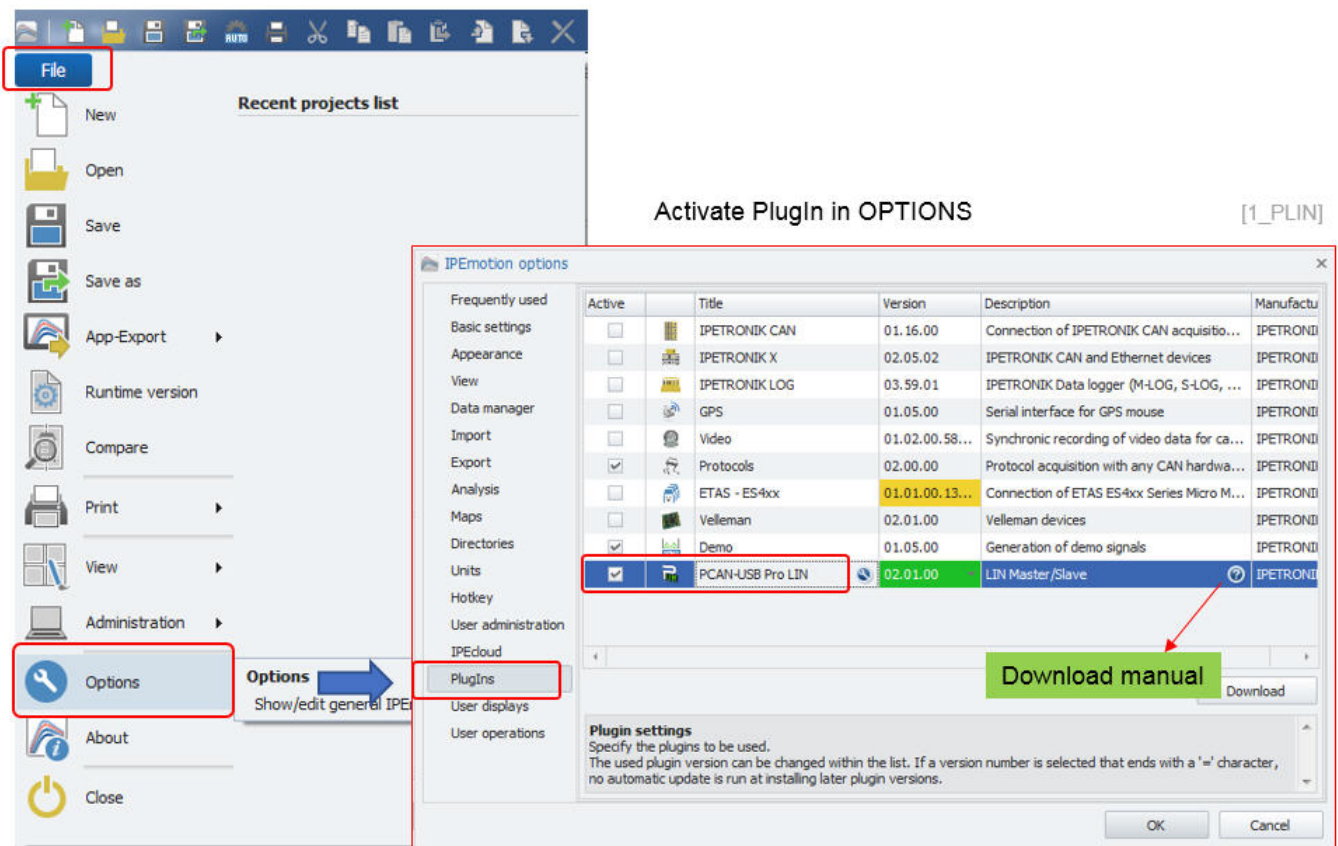

The PlugIn is supporting the following operating systems:

- ▶ Windows 32 bit
- ▶ Windows 64 bit

3 PlugIn configuration

3.1 Functional architecture

The following diagram shows the schematic system architecture. You need to establish a USB connection between your PC and the interface IPEcan Pro FD interfaces hardware. The connection to the LIN networks is established over the SUB-D 9 connector.

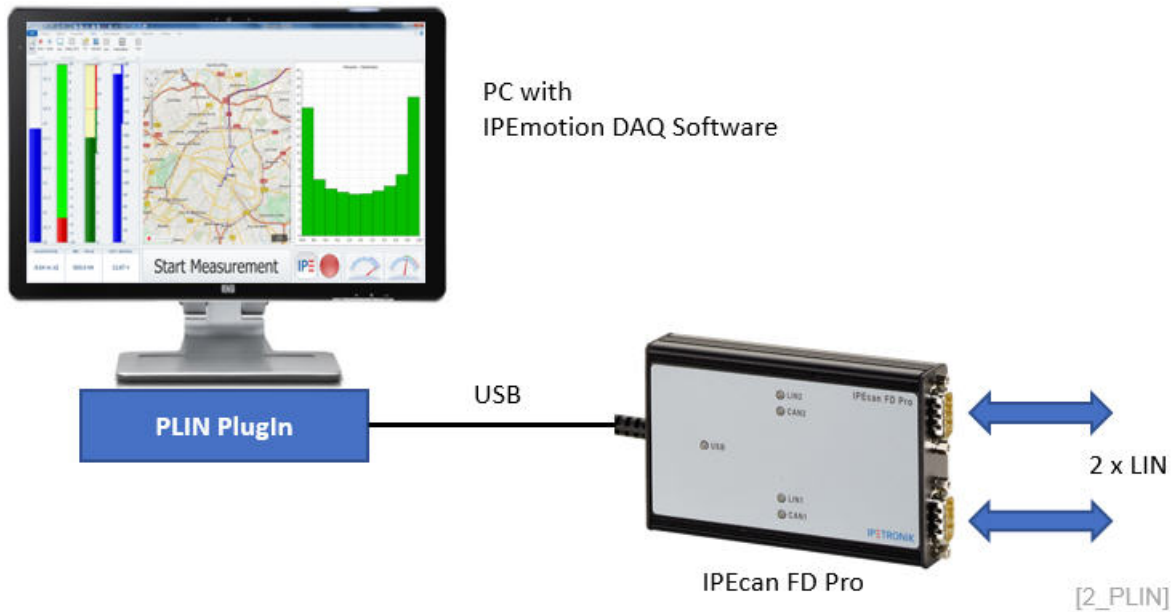

Information

This PlugIn is not supporting any LIN bus traffic measurement functions.

The PIN assignment of the SUB-D 9 connector is as following.

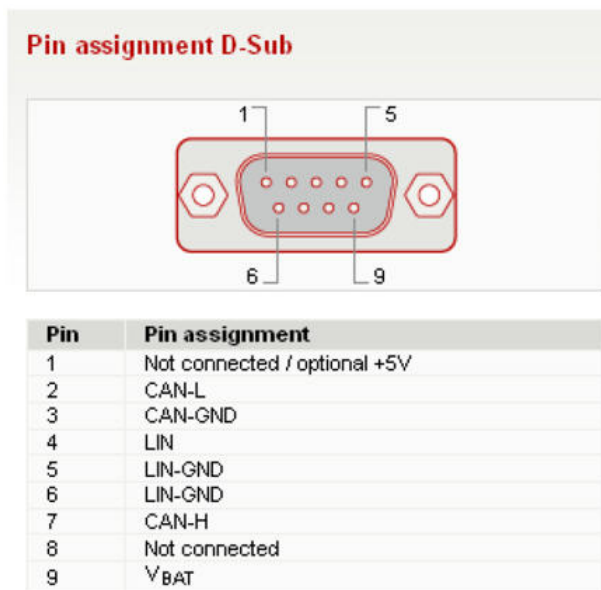

[3_PLIN]

3.2 Detecting interface hardware

In order to configure your measurement, you need to change to the SIGNALS work space and select the PLIN PlugIn from the hardware system drop down list, if you like to create the system manually. However due to the USB interface to the PC you can use the automatic detect function from the ribbon to create the interface too.

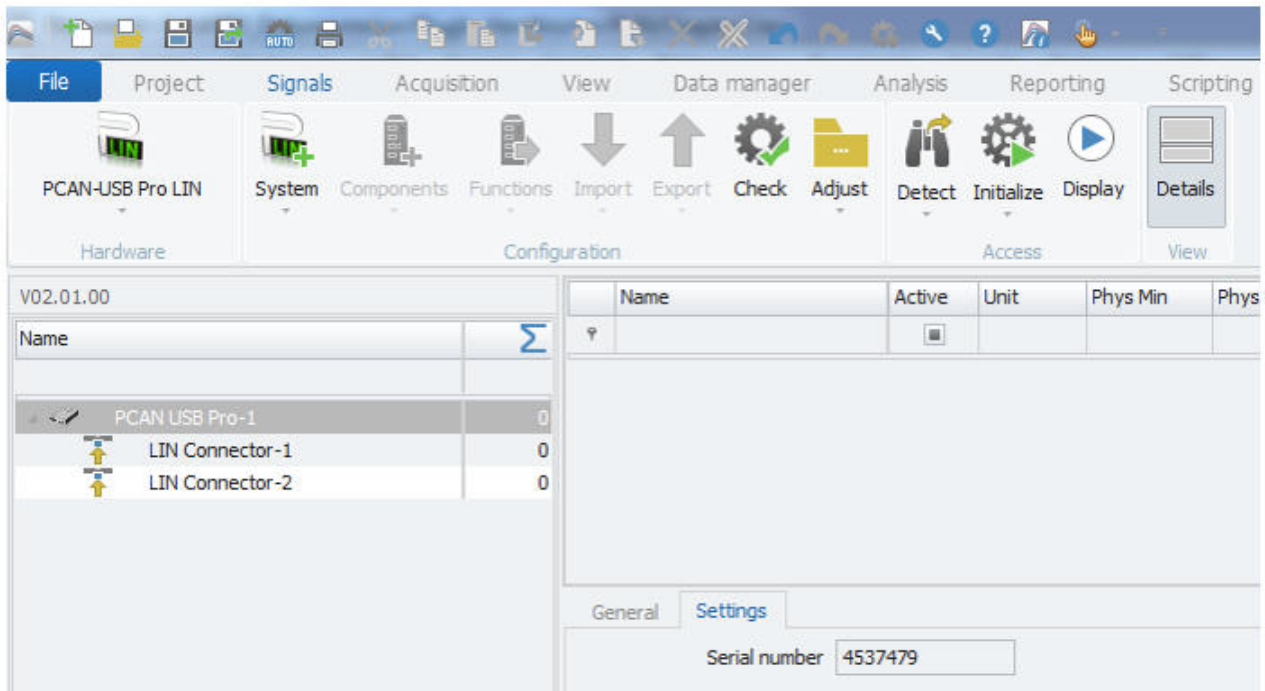

Hardware is detected

[4_PLIN]

After successful hardware detection the interface with 2 LIN connectors is created. Also, the serial number of the device is displayed on the settings tab sheet of the interface.

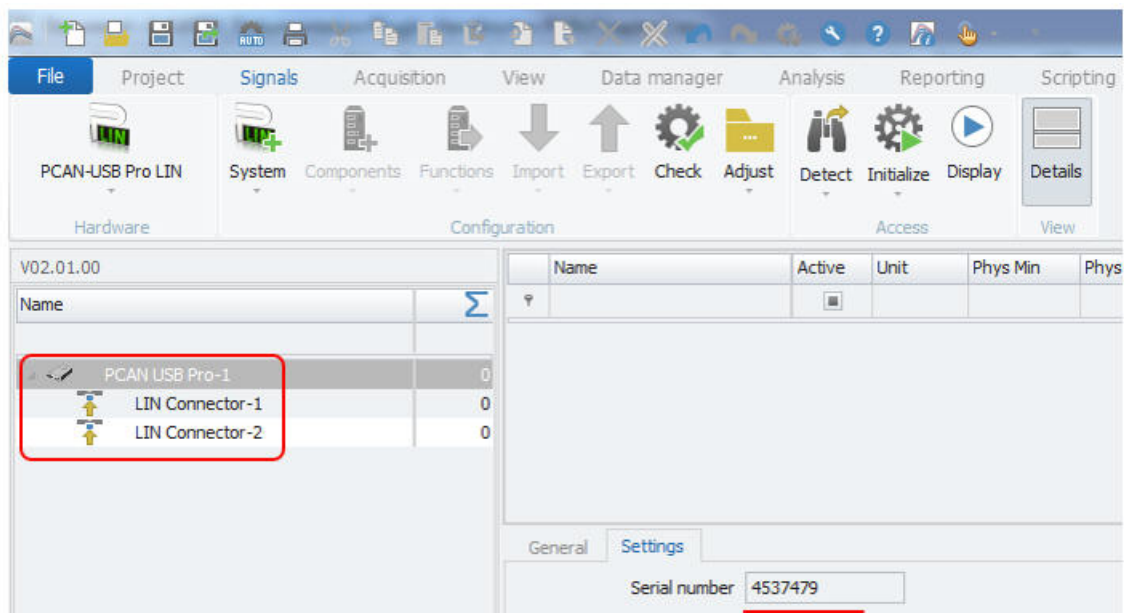

Hardware is detected

[5_PLIN]

3.3 LIN interface configuration

On LIN interface level you have configuration options for the baud rate and the LIN version. The PlugIn supports LIN standards 2.0 and 1.3. The default version is 2.0 The supported baud rates are:

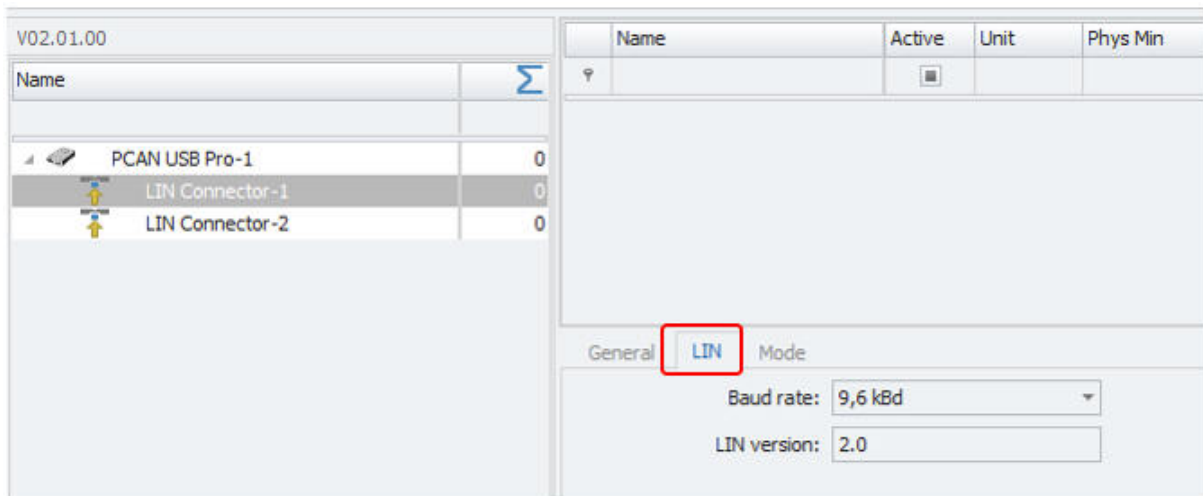

[6_PLIN]

- ▶ 1.2 kBaud
- ▶ 2.4 kBaud
- ▶ 4.8 kBaud
- ▶ 9.6 kBaud
- ▶ 19.2 kBaud

In the mode tab sheet you define the measurement mode. The required measurement mode is depending on your network architecture and the ECUs. The mode is defined from the perspective of the IPEmotion PC. When you configure the mode as master the PC with the IPEmotion software is the master and the corresponding network with the ECUs must operate as slaves. The architecture allows only one master in the network. In the case the master is part of the network the PC software should be configured in the slave mode.

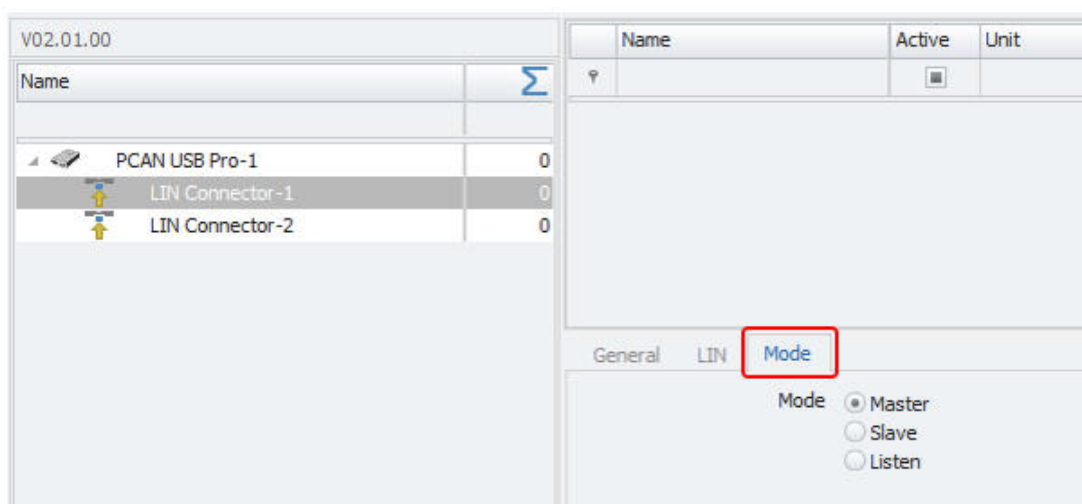

[7_PLIN]

- ▶ Master
- ▶ Slave
- ▶ Listen

3.3.1 LDF import

In order to configure your measurement you need to import the description file. The CAN db import supports the file extension .dbc, .ldf and .xml. The description files for LIN networks have .LDF extension.

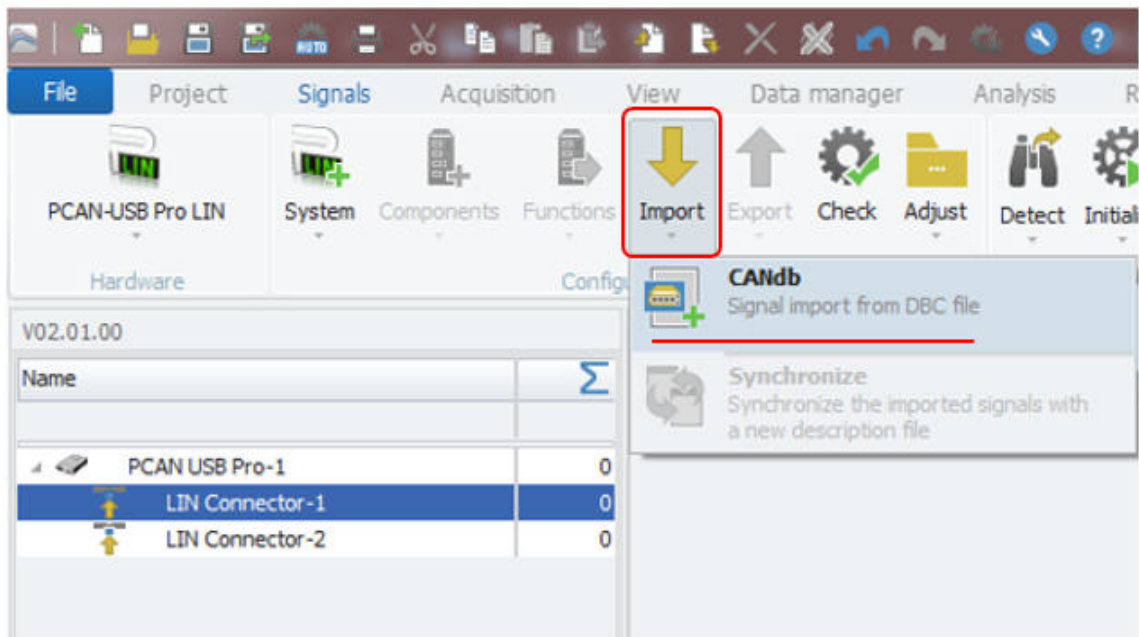

LDF import

[8_PLIN]

In the import dialog you select the signals you like to measure.

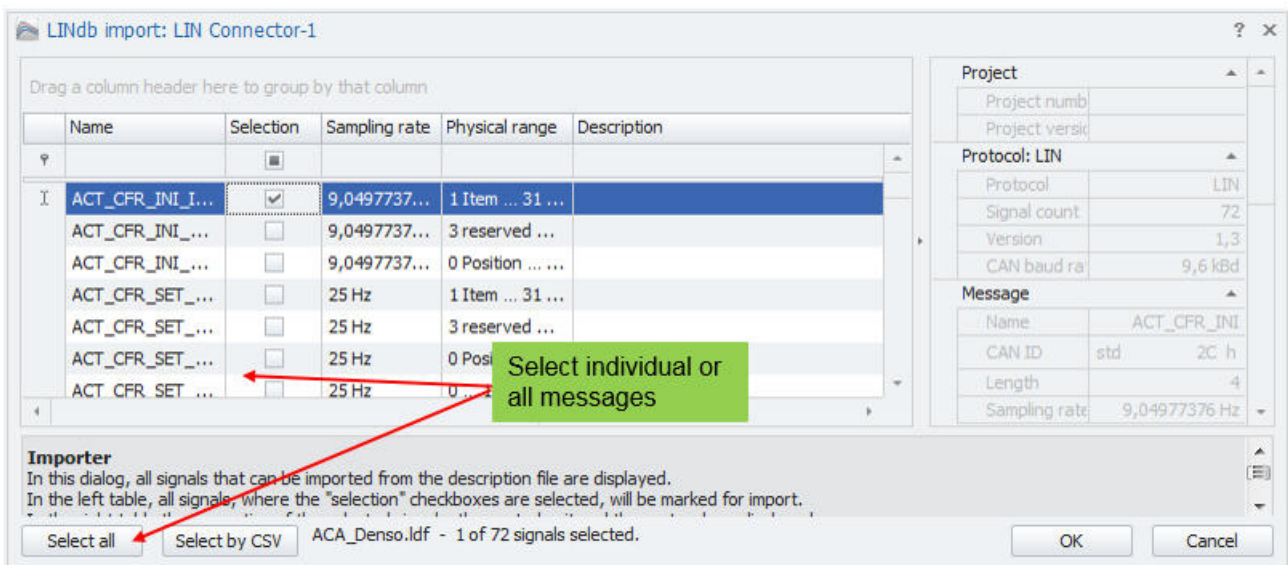

Import dialog

[9_PLIN]

3.3.2 Sending LIN messages

On channel level in the format tab sheet you can configure the data direction. The default direction if the LIN channel sins INPUT in order to measure LIN data.

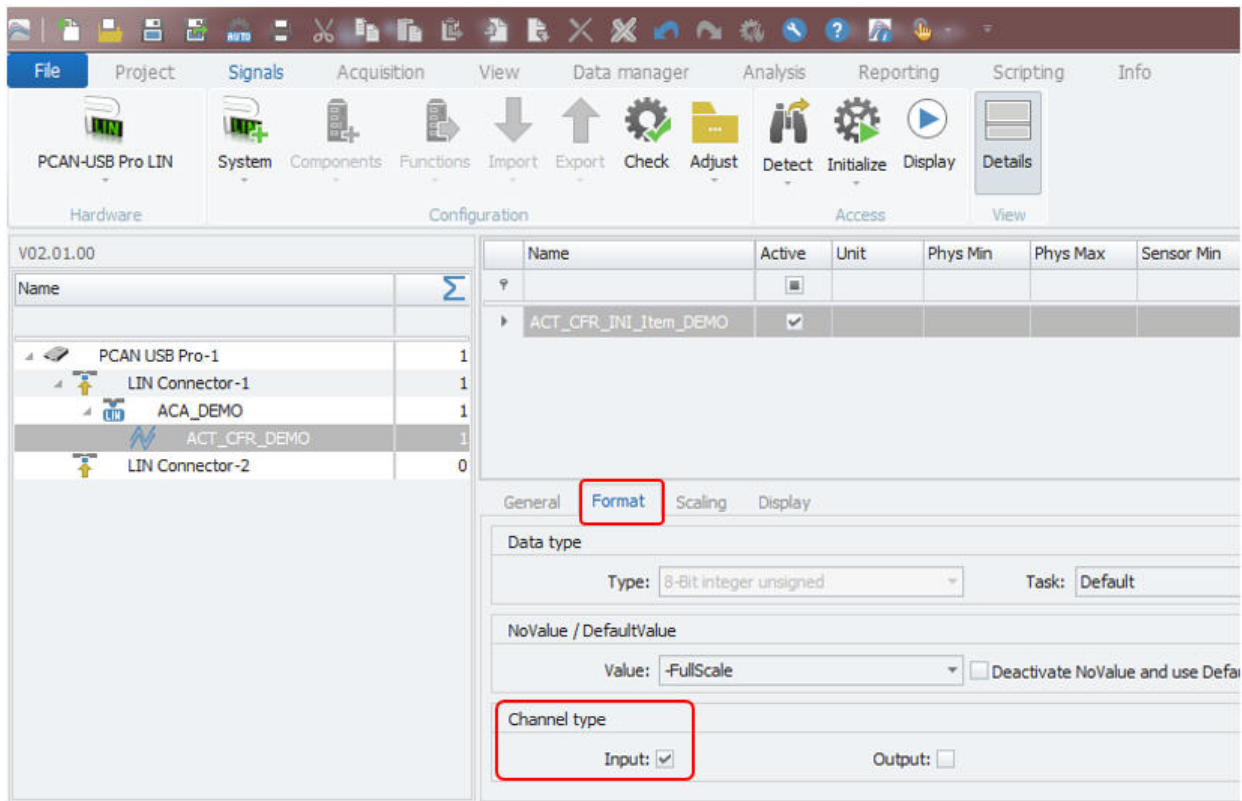

Input - for measurement

[10_PLIN]

If you like to send LIN data on channel level you can change the direction from input for measuring to output for sending data. You can use the slide controller or the alphanumeric instrument in order to define the values you like to send to the Lin network.

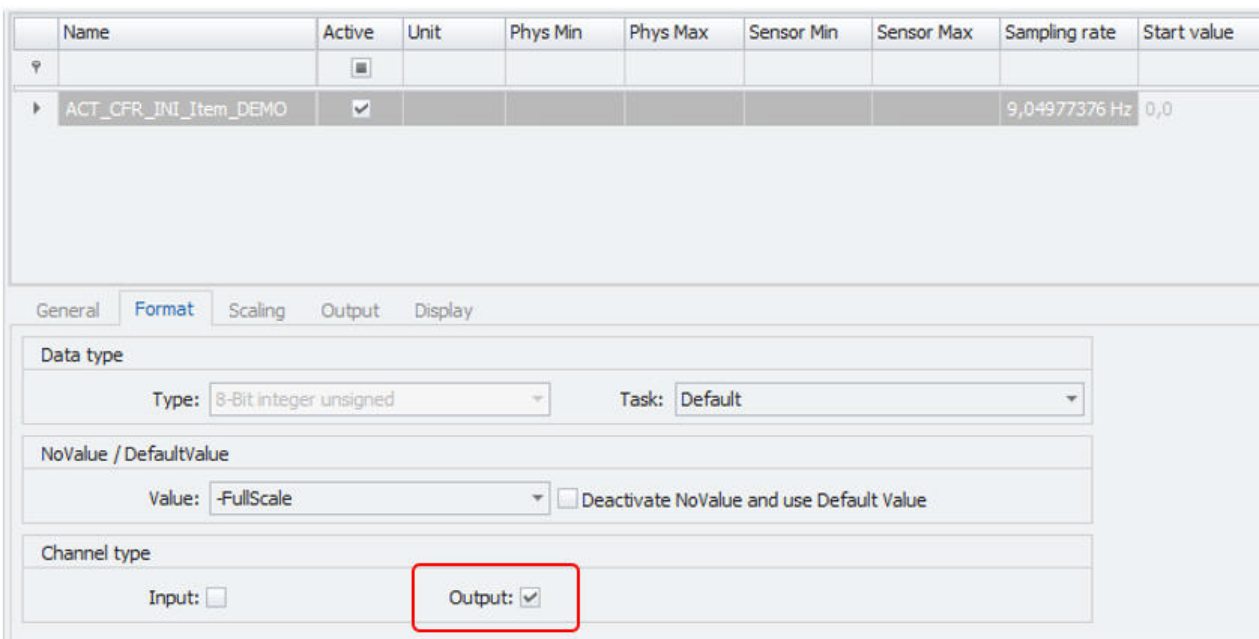

Output – for sending data

[11_PLIN]

Author: FOT