



# Table of contents

- 1 Important and general information..... 7**
  - 1.1 Important information ..... 7
    - 1.1.1 Safety and Warning instructions ..... 7
    - 1.1.2 Liability, Warranty, Copyright, License agreement ..... 7
  - 1.2 General information..... 8
    - 1.2.1 About this manual ..... 8
    - 1.2.2 Legend of used icons..... 8
    - 1.2.3 New features, Changes ..... 9
    - 1.2.4 Support..... 15
    - 1.2.5 Related documentation ..... 15
    - 1.2.6 Documentation feedback ..... 15
- 2 System basics..... 16**
  - 2.1 Data logger applications (extract) ..... 16
    - 2.1.1 Configuration, Online measurement using Ethernet..... 16
    - 2.1.2 Fleet data logger ..... 16
  - 2.2 Connecting devices via CAN bus ..... 17
    - 2.2.1 CAN bus basics ..... 17
  - 2.3 Ampacity and voltage drop..... 19
    - 2.3.1 Ampacity ..... 19
    - 2.3.2 Voltage drop..... 19
- 3 Data logger M-LOG, S-LOG, FLEETlog/FLEETlog2, IPElog ..... 20**
  - 3.1 Overview ..... 20
  - 3.2 Hardware..... 22
    - 3.2.1 Block diagram ..... 22
    - 3.2.2 Enclosure types ..... 22
    - 3.2.3 Port replicators and cables ..... 23
    - 3.2.4 Device panel for changing the internal memory card ..... 23
    - 3.2.5 External fuse for logger protection (IPElog, M-/S-LOG, FLEETlog) ..... 23
    - 3.2.6 Additional short-circuit protection for IPElog and FLEETlog..... 24
    - 3.2.7 LED status display (flashing codes)..... 24
    - 3.2.8 Power-down at excitation loss ..... 24
  - 3.3 Initial start-up..... 25
    - 3.3.1 Connecting the logger..... 25
    - 3.3.2 Detecting the logger, creating test configuration (Ethernet) ..... 26
    - 3.3.3 Add logger system, creating test configuration (USB stick)..... 27
    - 3.3.4 Static and dynamic IP addresses ..... 28
    - 3.3.5 Logger web interface for status and signal monitoring ..... 29
    - 3.3.6 Logger system with CAN modules..... 30

- 3.3.7 Access to data stored on the logger ..... 31
- 3.3.8 Synchronizing the logger time..... 32
- 3.3.9 Readout Hardware and license information..... 32
- 3.3.10 Updating the measurement application (TESTdrive) per USB stick..... 33
- 3.3.11 TESTdriveCMD.xml ..... 34
- 4 External connection ..... 36**
- 4.1 Grounding..... 36
  - 4.1.1 IPElog, M-LOG grounding connection ..... 36
  - 4.1.2 FLEETlog grounding connection ..... 36
- 4.2 PWR / Remote connection..... 36
  - 4.2.1 PWR/REM cable 620-574 ..... 36
  - 4.2.2 Remote connection ..... 37
- 4.3 Digital input/output connection ..... 38
  - 4.3.1 Connecting example digital input..... 38
  - 4.3.2 Connecting example digital output..... 38
  - 4.3.3 Connecting example external status LED..... 39
- 4.4 Bus inputs..... 39
  - 4.4.1 Connecting example CAN bus..... 39
  - 4.4.2 Connecting example LIN bus..... 39
- 5 Configuration with IPEmotion (extract) ..... 40**
- 5.1 First steps..... 40
  - 5.1.1 Main dialog..... 40
  - 5.1.2 The Title Bar..... 41
  - 5.1.3 The file menu ..... 41
  - 5.1.4 Using the options ..... 41
  - 5.1.5 Creating a support file..... 47
  - 5.1.6 IPEmotion working areas (main navigation tabs) ..... 48
  - 5.1.7 Info ..... 49
- 5.2 Logger settings..... 50
- 6 Basic functions..... 53**
- 6.1 Switching-on / switching-off..... 53
  - 6.1.1 Ignition line 15..... 53
  - 6.1.2 WakeOnCAN..... 54
  - 6.1.3 WakeOnRTC (IPElog/IPElog2 only) ..... 55
  - 6.1.4 StopStart event (Logger processing) ..... 56
  - 6.1.5 Use Cases..... 57
- 6.2 Triggering ..... 60
  - 6.2.1 Start-trigger ..... 60
  - 6.2.2 Stop-trigger ..... 60
  - 6.2.3 Start- and Stop-trigger ..... 61

- 6.2.4 Stop is inverted start ..... 61
- 6.2.5 Save trigger channel ..... 62
- 6.3 Data groups (storage, e-mail, traffic, statistic, novalue) ..... 63
  - 6.3.1 Storage groups ..... 64
  - 6.3.2 Mail groups..... 65
  - 6.3.3 Statistic group ..... 67
  - 6.3.4 NoValue group ..... 68
  - 6.3.5 Traffic groups ..... 68
  - 6.3.6 Trigger settings ..... 69
- 6.4 Status channels ..... 70
  - 6.4.1 Logger, Logger processing ..... 70
  - 6.4.2 Video recording ..... 70
- 6.5 USB medium for external storage ..... 71
  - 6.5.1 External medium is the data drive of the logger ..... 71
  - 6.5.2 External USB medium as supplemental data drive ..... 72
- 7 Standard functions ..... 76**
  - 7.1 Calculations ..... 76
    - 7.1.1 Mathematic functions and operations ..... 76
    - 7.1.2 Constants ..... 80
    - 7.1.3 NoValue and timeout settings ..... 80
    - 7.1.4 Calculation examples ..... 83
    - 7.1.5 Calculation ..... 87
  - 7.2 Digital inputs and outputs ..... 88
    - 7.2.1 Digital inputs..... 88
    - 7.2.2 Digital outputs ..... 88
  - 7.3 WakeOnCAN ..... 90
    - 7.3.1 ON via WakeOnCAN, OFF via Ignition 15 ..... 90
    - 7.3.2 ON via WakeOnCAN, OFF via Switch-off condition ..... 90
  - 7.4 CAN-Send: Output signals to CAN bus ..... 91
  - 7.5 Log file output via Hyperterminal..... 94
  - 7.6 Send e-mail with status information ..... 95
  - 7.7 Output messages to CAN / LIN ..... 96
  - 7.8 Event controlled measurement ..... 98
    - 7.8.1 Possibilities for data acquisition ..... 98
    - 7.8.2 Cyclic data recording of continuous signals..... 99
    - 7.8.3 Event-controlled data recording of bus signals ..... 100
    - 7.8.4 Setting up event-controlled data recording (PlugIn IPETRONIK-LOG) ..... 101
    - 7.8.5 Practical example: Determination of the latency of two signals..... 104
  - 7.9 Data storage ..... 105
  - 7.10 Data transfer & communication ..... 106

<b>8</b>	<b>Options (license required)</b> .....	<b>107</b>
8.1	Hardware options (internal).....	107
8.1.1	CAN cards.....	107
8.1.2	CAN / LIN cards.....	107
8.1.3	Ethernet cards.....	107
8.2	Software options.....	108
8.2.1	Import signal description files.....	108
8.2.2	Detection mode and cycle rate.....	116
8.2.3	Traffic acquisition.....	116
8.2.4	Statistics calculation.....	121
8.2.5	Operating in FTP mode (terminal server).....	123
8.2.6	Recording audio and video data.....	123
8.2.7	OBD-2 measurement.....	124
8.2.8	UDS protocol (Unified Diagnostic Services).....	126
8.3	Recording GPS-Data.....	127
8.4	Remote data transfer.....	128
8.4.1	Transferring data using GPRS and Internet to FTP server.....	128
8.4.2	Transferring data using Wireless LAN to network server.....	129
8.4.3	Data transfer configuration.....	130
8.5	Configuring COMgate.....	131
<b>9</b>	<b>Display modules</b> .....	<b>135</b>
9.1	M-VIEW <i>fleet</i> .....	135
9.1.1	Keys and LEDs.....	136
9.1.2	Configuring M-VIEW <i>fleet</i> .....	137
9.2	IPEconnect (Online display with Smartphone or tablet).....	140
9.2.1	Overview.....	140
9.2.2	Features.....	140
9.2.3	Cables.....	141
9.2.4	Settings.....	141
9.2.5	App display.....	143
9.3	Connecting displays via openABK.....	144
9.3.1	Cable connection.....	144
9.3.2	Display configuration.....	144
9.3.3	Use display buttons for triggering.....	144
<b>10</b>	<b>Accessories</b> .....	<b>145</b>
10.1	Electrical accessories.....	145
10.1.1	COMgate.....	145
10.1.2	CAN Extender.....	146
10.1.3	IPEwifi.....	146
10.1.4	GPS receiver.....	148

- 10.1.5 Bus isolator SAM-CAN-ISO ..... 148
- 10.1.6 iMIC ..... 148
- 10.1.7 Mountings..... 150
- 10.2 CAN FD and FlexRay Satelites ..... 151
- 11 Appendix ..... 152**
- 11.1 Cable connection and Pin assignment..... 152
  - 11.1.1 M-LOG port replicators ..... 152
  - 11.1.2 FLEETlog2-01 ..... 155
  - 11.1.3 FLEETlog2-03..... 156
  - 11.1.4 FLEETlog ..... 157
  - 11.1.5 IPElog..... 158
  - 11.1.6 IPElog2-01 (16 CAN) ..... 159
  - 11.1.7 IPElog2-02 (10 CAN, 6 LIN)..... 160
- 11.2 Starting up ..... 161
  - 11.2.1 Overview Configuration & Measurement ..... 161
  - 11.2.2 Flow chart of the measuring process ..... 162
- 11.3 Practical examples ..... 163
  - 11.3.1 Calculating memory footprint ..... 163
  - 11.3.2 Linear signal scaling ..... 164
- 11.4 Status messages..... 167
  - 11.4.1 Most important status messages ..... 167
  - 11.4.2 Warning and error messages after program update..... 168
- 11.5 Description of TESTdrive files..... 169
  - 11.5.1 Data types ..... 170

# 1 Important and general information

## 1.1 Important information

Please follow these instructions before and during the use and application on any IPETRONIK product!

### 1.1.1 Safety and Warning instructions

Please follow the instructions **and** information as contained in the user manual!

1. The user can **influence an electronic system by applying the IPETRONIK product**. This might cause risk of personal injury or property damages.
2. The **use and application of the IPETRONIK product is permitted only to qualified professional staff**, as well as, only in appropriate manner and in the designated use.
3. **Before using an IPETRONIK measurement system in the vehicle it has to be verified that no function of the vehicle, which is relevant for secure operation, might be influenced:**
  - by the installation of the IPETRONIK measurement system in the vehicle,
  - by an potential malfunction of the IPETRONIK system during the test drive.

In order to avoid possible danger or personal injury and property damages, appropriate actions are to be taken; such actions have to bring the entire system into a secured condition (e.g. by using a system for emergency stop, an emergency operation, monitoring of critical values).

Please check the following points to avoid errors:

- Adaption of sensors to components of the electrical system / electronics, brake system, engine and transmission control, chassis, body.
- Tap of one or several bus systems (CAN, LIN, ETHERNET) including the required electrical connection(s) for data acquisition.
- Communication with the vehicle's control units (ECUs), especially with such of the brake system and/or of the engine and transmission control (power train control system).
- Installation of components for remote data transmission (mobiles, GSM/GPRS modems, WiFi and Bluetooth components).



4. IPETRONIK devices are designed for applications in **extended temperature ranges > 70 °C (158 °F)**. A high environmental temperature and the module's self-heating may cause burns of the skin when touching the hot surface. In order to avoid the risk of injury we recommend to take care for appropriate safety precautions (e.g. contact protection, covering/enclosure, warning sign, ... )..
5. **Before directly or indirectly using the data acquired by an IPETRONIK measurement system to calibrate control units, please review the data regarding to plausibility.**
6. With regard to the application of IPETRONIK products in vehicles during use on public roads the manufacturer and/or registered user of the vehicle **has to ensure that all changes/modifications have no influence concerning the license of the vehicle or its license of operation.**
7. **User does agree to the instructions and regulations as mentioned above.** In case the user does not agree with the instructions and regulations as mentioned above, he has to notify this expressly and immediately in writing to IPETRONIK before confirming the sales contract.

### 1.1.2 Liability, Warranty, Copyright, License agreement

Please refer to <http://www.ipetronik.com/en/terms-conditions> for detailed contract information:

- ▶ Limitation of liability
- ▶ Warranty
- ▶ Copyright and Duplication
- ▶ Software license agreement

## 1.2 General information

### 1.2.1 About this manual

The manual describes the structure of the IPEmeasue data logger devices M-LOG / M-LOG V3, S-LOG, FLEETlog / FLEETlog2 and IPElog / IPElog2, as well as, peripheral devices and accessories components.

© 2018 All rights reserved !

### IPEmotion PlugIn IPETRONIK-LOG

Descriptions in this documentation refer to the current release. Please note, that the logger requires the corresponding application software TESTdrive.



*To run this PlugIn an release ≥ IPEmotion 2017 R2 has to be installed on your computer.*

### IPEmotion

Contents described in this document relates to the release versions IPEmotion 06.00.00 (2016) to IPEmotion 07.02.00 (2017 R3).

IPEmotion 2017 requires Microsoft .NET 4.5.1 Framework. This version is no longer supported by Windows XP.

### 1.2.2 Legend of used icons

**Tip**

*This icon indicates a useful tip that facilitates the application of the software.*

**Information**

*This icon indicates additional information for a better understanding.*

**Attention!**

*This icon indicates important information to avoid potential error messages.*



### 1.2.3 New features, Changes

Please also refer to the latest release notes at:

c:\Program Files (x86)\IPETRONIK\IPEmotion PlugIn IPETRONIK LOG V03.5x.xx\Help\

PlugIn IPETRONIK-LOG V03.62		Release May 2018
No.	Feature	Description
1	Bug fixing, optimizations	FlexRay Satellite according to the release notes

PlugIn IPETRONIK-LOG V03.61		Release May 2018
No.	Feature	Description
1	Bug fixing, optimizations	M-CNT2, M-LOG V3, CAN FD Satellite according to the release notes

PlugIn IPETRONIK-LOG V03.60		Release January 2018
No.	Feature	Description
1	PlugIn LOG / X in parallel	Activating the PlugIn IPETRONIK-LOG and the PlugIn IPETRONIK-X (simultaneous operation) is supported.
2	openABK functions	Implemented functions of the logger display & control concept openABK buttons, openABK DHCP server, openABK unique names

PlugIn IPETRONIK-LOG V03.59		Release November 2017
No.	Feature	Description
1	IPElog2 access point	WiFi access point support
2	IPEwifi V3	External device for WiFi data transfer with M-LOG V3
3	Transfer category FTP server	Up to 3 categories can be assigned to an FTP server
4	Transfer category LOG files	Up to 3 categories can be assigned to the log file
5	XCP: Disconnect Second Tester	Delay time after the the second tester will be disconnected
6	ECU CCP parameters	Optionally use CCP parameters from ECU
7	UDS security access	Security access for the UDS protocol
8	SFTP resume	Resume is active: The data transfer will be continued where it has been stopped with the previous transfer. Resume inactive: A corresponding and already existing file on the FTP server will be overwritten.
9	Transmit traffic messages	Transmit messages in traffic groups
10	IPElog2 gyro sensor	Support of IPElog2 internal gyro sensor
11	Data transfer parameters	Default values for data transfer parameters have been adapted
12	Project properties	Project properties are no longer stored in mea_conf
13	PlugIn LOG / X in parallel	PlugIn IPETRONIK-LOG and IPETRONIK-X activated in parallel might cause software problems

PlugIn IPETRONIK-LOG V03.58		Release February 2017
No.	Feature	Description
1	Cisco VPN removed	Cisco VPN settings will be deleted when loading a former configuration (GUI access no longer supported).
2	SW filter frequency selection	Software filter frequency now as drop-down menu selection
3	Export of channel comments	Activation at Options > PlugIns > IPETRONIK LOG > IPEmotion settings > Options > Extended > IPETRONIK CAN, default = deactivated
4	New OBD channels	Supported PIDs: 102 - 106, 108 - 110, 112 - 124, 127, 131
5	Radius calculation (polar)	$Radius = \text{SQRT}("phi\_y" * "phi\_y" + "phi\_z" * "phi\_z")$
6	Angle calculation (polar)	$Angle = \text{IF}("phi\_z" >= 0; \text{ACOS}("phi\_y" / "Radius") * 180/\text{PI}; -1 * \text{ACOS}("phi\_y" / "Radius") * 180/\text{PI} + 360)$
7	Calculation ISNOVSALUE	ISNOVALUE (x;y), NoValue detection with delay
8	External video data storage	Storing video data on external USB medium
9	Sign-of-live	Connecting status between logger and web interface
10	Measurement status file with wake up reason	New entry wake up reason: Unknown/ Remote/ Wake On CAN/ No Message Lost/ Wake On RTC/ Modem (SMS)/ low voltage
11	TESTdriveCmd DataTransfer	The new parameter „transfer“ controls the data post processing. Depending on its status (true/ false) zipped and splitted files will be copied to the USB stick subsequently.
12	Remote2 (M-LOG V3, IPElog2)	2nd input in addition to the control input Remote 1 (e.g. ignition line 15) as OR-conjunction solely supported with the Power-IN/Remote connector of M-LOG V3 and IPElog2

PlugIn IPETRONIK-LOG V03.57		Release July 2016
No.	Feature	Description
1	IPElog2 support	Hardware type 10x CAN, 6x LIN, 2x ETH, WLAN Hardware type 16x CAN, 2x ETH, WLAN
2	Quickstart data options	Off, During boot-up, During boot-up + Measurement Stop-Start
3	Available WLAN networks	Cyclic SSID scan provides latest WLAN status information (logger with built-in WLAN unit required)
4	New UDS super job	PST_LESEN_UDS_2
5	UDS check string	Comparing the „SearchString“ of the UDS job and the ECUs reply
6	Indication of CAN/LIN bus activity	Creating status entry in Log file / Measurement status file once the timeout delay of the respective CAN/LIN input expired
7	Hardware description file	New backup of the HW_descr.xml prevents from illegal access
8	Data post processing	User configurable Start Delay / Retry Delay time (range 10 s ... 5 min) to trigger the parallel data post processing
9	Use last value from previous measurement	Using the last value from previous measurement as start value for a signal calculation within the current measurement
10	Category overview	Selection list for the data transfer category
11	XCPonUDP import	Import of A2L description files using an USB2ETH adapter

PlugIn IPETRONIK-LOG V03.56		Release April 2016
No.	Feature	Description
1	Multi CAN-Send	CAN node supporting multiple CAN-Send blocks
2	GPS channels added	GPS latitude in degrees, GPS longitude in degrees
3	openABK capable display	Support of the openABK protocol V1.0 for EMBU-SYS displays
4	Logger status info	Web interface showing logger status information and signal list
5	IPEconnect access point	IPEhub2 supports access point operation for online data visualization with mobile devices (smartphone, tablet)
6	J1939 extension	Event triggered measurement in signal mode
7	UDS extension Second Tester	Configuration of an additional tester ID

PlugIn IPETRONIK-LOG V03.55		Release August 2015
No.	Feature	Description
1	M-LOG V3	Support of new data logger M-LOG V3
2	FLEETlog2-03	Support of FLEETlog2 with D Sub D connector (CAN, DI/O)
3	IPElog 6x CAN, 6x LIN	Data logger IPElog providing 6 CAN and 6 LIN inputs available
4	M-VIEWfleet, scaling	Multipoint scaling for M-VIEWfleet supported
5	USB video	- Support of multiple USB cameras via USB hub - Support of Logitech QuickCAM VisionPro (DID 0x09A6)
6	Mail groups, recipients list	Separate list of mail recipients per mail group
7	Serial number specific program/configuration update (mcf, fcf, rtb, prg)	Verification of the logger serial number for program/configuration update (mcf, fcf, rtb, prg). In case of mismatch, the latest valid file is used.
8	Import of PDX files	One or more PDX files can be imported for each CAN node
9	NoValue group	Extended NoValue monitoring with with new data group „NoValue group“ (Logger processing). User defined formulas for trigger conditions are supported.
10	Send category „NoTransfer“	Additional send category „NoTransfer“ in order to exclude user defined data from transfer.
11	CCP, XCP second tester	Check for second tester connected to the bus before starting ECU communication.
12	CCP, XCP EPK mismatch	Selectable behaviour in case of EPK mismatch. (default setting: proceed measurement)
13	New parameter <meaNumber> for TESTdriveCmd.xml	The service <dataTransfer> now provides the new parameter <meaNumber> in order to send defined mea files in advance (per modem), instead of at the end of the test drive trip.
14	IPEconverter	Refer to manual IPEconverter V03.55 for latest extensions

PlugIn IPETRONIK-LOG V03.54		Release November 2014
No.	Feature	Description
1	M-LOG 6 CAN M-LOG 3 CAN / 1 LIN	Support of new M-LOG measurement interfaces
2	New CAN devices	Support of M-SENS2 250 Hz, M-UNI2, M-THERMO2 HV, CANpressure 150 bar
3	Diagnostic measurement	Set trigger conditions to start diagnostic jobs
4	CAN Timeout value	User defined value for the timeout. Without a valid signal value after the timeout has expired, the system will indicate "NoValue"
5	DAQ polling groups (polling list)	ECU signals can be allocated to different polling groups. Up to 4 groups can be defined by user
6	Seed&Key file using the XCP protocol	Set file location for the Seed&Key file.
7	XCPonCAN extension	New Protocol status channel with XCP, CCP, KWP, UDS
8	CAN-Send extensions	New columns bit count and data format added
9	Statistic Group (Min/Max list) (STG file)	Activation of the min/max list calculation has been modified. Requested signals can be assigned to max number of 4 statistic groups.
10	File transfer categories	Storage, traffic and statistic groups can be assigned to a file transfer category. Each of 3 categories can use a data transfer medium (LAN, WLAN or COMgate).
11	Disable USB stick data exchange	Automatic data download / configuration upload can be enabled/disabled with the PlugIn options settings.
12	Logger reset	Reset the logger to factory default settings (DIN 01 = active)
13	IPEcloud	Define access parameters for data download from FTP server. Measurement data can be imported directly using IPEmotion's Data manager and Analysis tools.
14	J1939 extensions	Activate J1939 protocol information DM1 messages conversion methods
15	DLM	Optional path for user operations (DLM) C:\Users\Public\Documents\IPETRONIK\IPEmotion\Custom\User Operation
16	XCPonCAN and XCPonUDP with additional storage rates	30/min, 12/min, 6/min, 1/min, 2/h, 1/h
15	IPElog extensions WakeOnSMS Rescue configuration Provider blacklist	Start IPElog per SMS from standby mode Export rescue configuration Create provider blacklist to exclude them for data transfer
16	Time zone status information	Enable the use of time zone status information (UTC status) with the PlugIn options settings
17	exFAT format of the SSD card used with IPElog	Format SSD drive using the exFAT data format which supports memory sizes up to 512 Terra bytes
18	S.M.A.R.T.	Support of Self-Monitoring, Analysis and Reporting Technology with the appropriate storage medium

PlugIn IPETRONIK-LOG V03.54		Release November 2014 (continuation)
No.	Feature	Description
19	Event based measurements in MDF4 data format	Channels of a CAN measurement with disabled cyclic acquisition (Event controlled) will be stored using the MDF4 format.
20	Count ECU data requests	All ECU data requests (means successful and unsuccessful attempts) will be logged.
21	Mail groups	Support of sending e-mails parallel to data post processing.
22	IPEconverter extensions ASAM ATF/XML export DIAdem TDM/DAT export CSV, Excel2003/2010 export	NoValue handling, grouping mode new data format types V-TAB scaling, rounded floating values

PlugIn IPETRONIK-LOG V03.53		Release April 2014
No.	Feature	Description
1	LOG2PC (ETH communication) IP 239.192.0.5 at port 7302	The UPD based protocol uses multicasts now, Firewall settings must not refuse the use of this port/IP.
2	TESTdrive update to V03.53.xx	Execute initial update of the logger software by USB stick. Following updates are supported by LOG2PC as usual.

PlugIn IPETRONIK-LOG V03.52		Release December 2013
No.	Feature	Description
1	FLEETlog2 support	Data logger FLEETlog2 is supported now
2	CAN-Send extensions	Send counter with individual settings for start bit, bit length, and data format, Signal output with individual settings for start bit, bit length, and data format in expert mode
3	J1939 extensions	J1939 protocol including DM1 signals refer to separate documentation J1939_DM1
4	OBD 2 extensions	Single PID, status channel, trigger conditions
5	External storage medium (USB)	Selectable for signal and traffic storage groups TESTdriveCmd.xml required
6	Traffic measurement extensions	Ring buffer, Filter functions
7	CAN ID assignment	Automatic assignment during system identification > IPEmotion Options > PlugIn specific settings
8	Measurement stop with automatic restart	StopStart event (logger processing) stops the current measurement and restarts immediately
9	New status signals	Video file size, Measurement number, OBD-2 processing
10	New calculation	INT_ADD()
11	Hardware license information	Logger context menu Extras shows hardware license information from the description file (hw_descr.xml)
12	Licensing of traffic groups	License verification of storage and traffic groups

PlugIn IPETRONIK-LOG V03.51		Release July 2013
No.	Feature	Description
1	PIN assignment	FLEETlog and IPElog added
2	Traffic storage groups	Traffic measurement now support different storage groups
3	Extension for IPElog (requires PIC ≥ V01.01.07, FPGA ≥ V01.02.08)	NoMessageLost function (NML) WakeOnCAN can be activated for each channel up to 6 ID triggers Logger restart using WakeOnCAN or remote signal CAN-ID trigger now StartNotStopTrigger (instead StartOnly) PIC update per job executable Status indication of the flap for the storage medium with M-VIEWfleet
4	CCP	Command CCP_DISCONNECT implemented
5	Upload and download	Supported with different transfer media (Modem, WiFi)
6	Event controlled measurement	CAN data acquisition based on traffic measurement but handled as signal measurement (DAT format)
7	Masks	for CAN identifiers are supported now
8	File name length	Up to 260 characters are allowed for file names of the external library and configuration files.
9	Stop date, Stop time	Stored as project property with the traffic file
10	PreTriggerTime, PostTriggerTime	Supported as project property

PlugIn IPETRONIK-LOG V03.50		Release October 2012
No.	Feature	Description
1	<b>Notes</b> Version reference SC1200 IPElog	Logger PlugIn ≥ 3.5x requires IPEmotion ≥ 2.xx M-LOG with SC1200 is no longer supported Requires TESTdrive / PlugIn IPETRONIK-LOG ≥ 3.5x
2	Status signal "FIFO overrun"	Indicates the data processing status. Output 0 = OK, Output 1 = processor overloaded
3	Debounce time of the remote signal	Configurable delay time within a range of 0 ... 5 seconds. The signal status ist valid if the remote signal lasts for this time without interruption.
4	Extensions TESTdriveCmd.xml	New jobs "OnOK" and "OnError" used for audible alarm of the job "OnConnect"
5	Differnt init modes for module initialization	Connected IPETRONIK modules will be initialized on command: Never, Once-only, Always.
6	Status e-mail with snap shot report	Each time the trigger condition is fulfilled, the current signal values (configured in the mail group) will be sent per mail.
7	Limit display with M-VIEWvga	Indication of limit violation has been revised.
8	V-TABs enable clear text display	Individual text can be assigned to different signal values (or ranges) which is respectively displayed (instead of digits).

## 1.2.4 Support

### Headquarter:

#### **IPETRONIK GmbH & Co. KG**

Im Rollfeld 28

76532 Baden-Baden, Germany

Phone +49 7221 9922 0

Fax +49 7221 9922 100

info@ipetronik.com

www.ipetronik.com

Limited commercial partnership with its head office in Baden-Baden, registry court HRA No. 201313

IPETRONIK Verwaltungs-GmbH Baden-Baden is an individually liable society, registry court Mannheim HRB No. 202089

CEOs: Andreas Wocke, Christian Buchholz

### **Technical support and product information**

www.ipetronik.com      e-mail: support@ipetronik.com

## 1.2.5 Related documentation

### **IPEmotion**

The documentation IPEmotion.pdf provides you with a description and useful information related to IPEmotion. This documentation is stored in the following standard language dependent directory:  
C:\Programs\IPETRONIK\IPEmotion Vxx.xx.xx\Help

## 1.2.6 Documentation feedback

At IPETRONIK, the technical publications team strives to produce documentations of the highest quality and values your feedback as a reader and user. If you have any comments or suggestions regarding our product manuals, contact us under [support@ipetronik.com](mailto:support@ipetronik.com).

When commenting on our products, please include the following information:

Version number

Name of the guide

Page number or section title

Brief description of the content (e.g. inaccurate instructions, grammatical errors, or information that require clarification)

Any suggestions for a general documentation improvement

## 2 System basics

### 2.1 Data logger applications (extract)

#### 2.1.1 Configuration, Online measurement using Ethernet

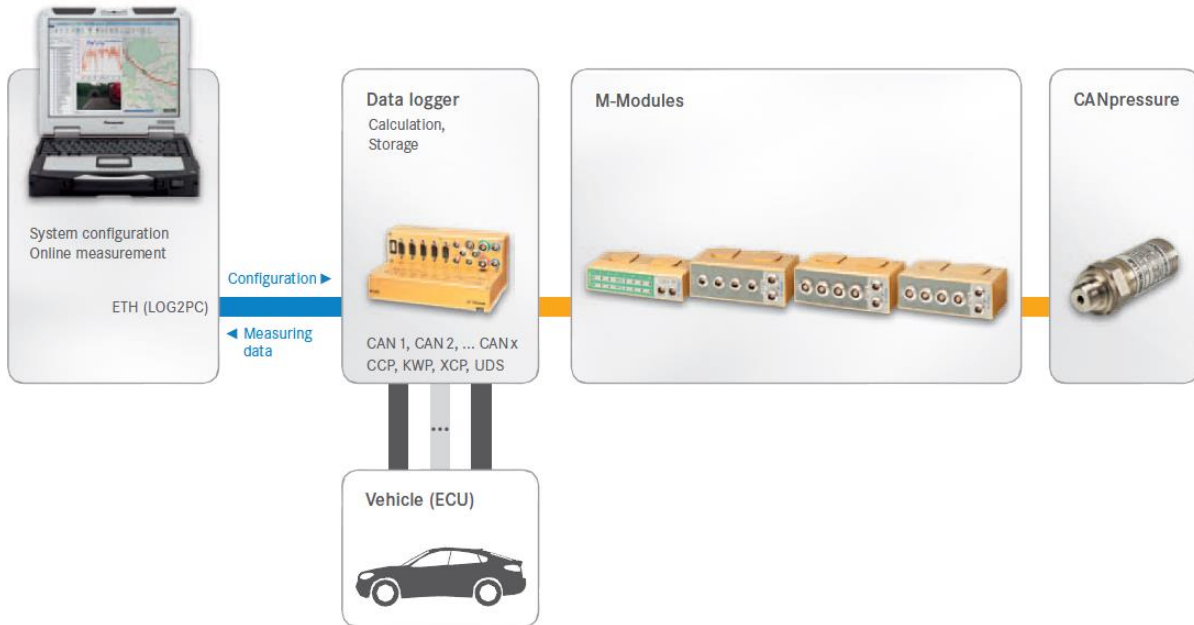

#### 2.1.2 Fleet data logger

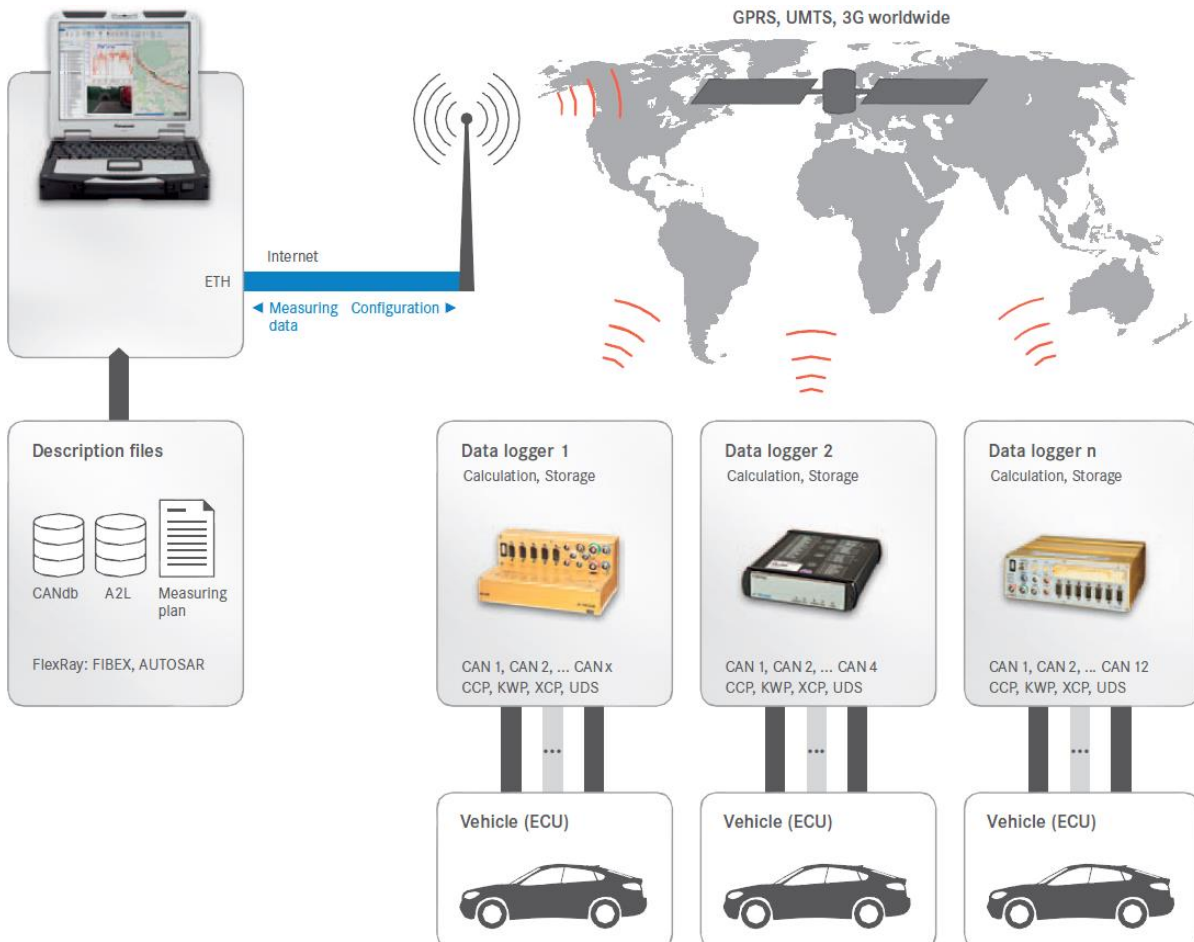



## 2.2 Connecting devices via CAN bus

### 2.2.1 CAN bus basics

#### CAN-Standard

The communication of the IPETRONIK SIM and M devices takes place by using the CAN bus according to the CAN 2.0 A (11 Bit Identifier) and CAN 2.0 B (29 Bit Identifier) specification. Each software application, which is able to process CAN data through a suitable interface can acquire measurement data from IPETRONIK CAN devices.

**User data within the CAN message:**  
A CAN message can transfer 8 values in Byte format resp. 4 values in Word format.

#### Structure of a CAN message

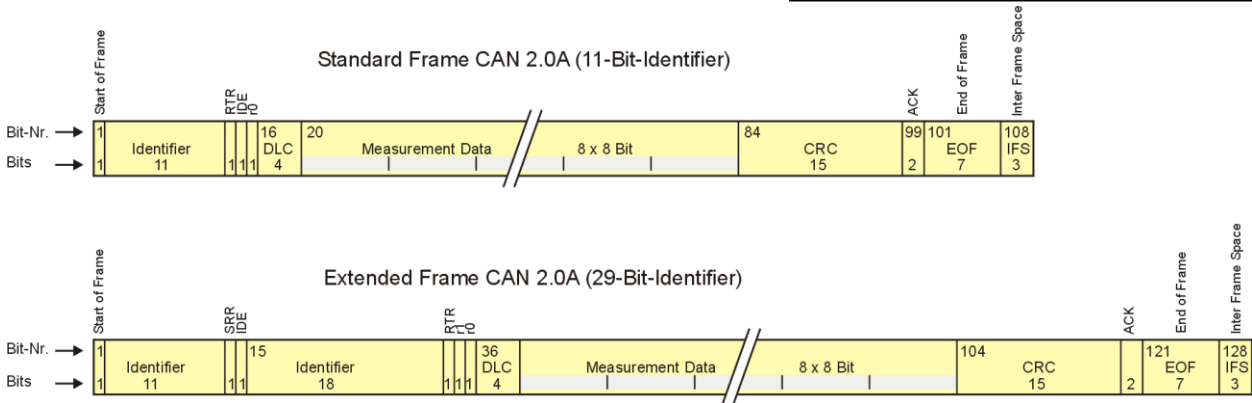

CAN 2.0A (11 Bit Identifier)			CAN 2.0B (29 Bit Identifier)		
Bits		Description	Bits		Description
1	SOF	Start of Frame	1	SOF	Start of Frame
11	ID	Identifier	11	ID	Identifier
1	RTR	Remote Transmission Request	1	SRR	
1	IDE	Identifier Extension (0)	1	IDE	Identifier Extension (1)
			18	ID	Identifier (extended)
			1	RTR	Remote Transmission Request
			1	r1	
1	r0		1	r0	
4	DLC	Number of following data bytes	4	DLC	Number of following data bytes
64	Data	Data bytes	64	Data	Data bytes
15	CRC	Error Identification Code	15	CRC	Error Identification Code
2	ACK	Acknowledge	2	ACK	Acknowledge
10	EOF	End of Frame, Inter frame space	10	EOFS	End of Frame, Inter frame space
110		Total number of bits	130		Total number of bits

Word	Byte	Bit (Message layout in the displaying format „Intel Standard“)							
0	0	7	6	5	4	3	2	1	0
	1	15	14	13	12	11	10	9	8
1	2	23	22	21	20	19	18	17	16
	3	31	30	29	28	27	26	25	24
2	4	39	38	37	36	35	34	33	32
	5	47	46	45	44	43	42	41	40
3	6	55	54	53	52	51	50	49	48
	7	63	62	61	60	59	58	57	56

## Access to the CAN bus, Transferring properties

The CAN bus allows a safe and effective data transfer of the connected devices (non-destructive bitwise arbitration = resource distribution to different devices). The CAN bus is therefore used as a standard communication medium in the automotive area and the industrial automation.

### The most important characteristic CAN bus properties are:

- ▶ Every bus participant (node) can send, as well as, receive.
- ▶ First of all, the node, which wants to send, needs the authorization. All participants become automatically a recipient (There is no abortion of the data sending process > non-destructive collision).
- ▶ No stations are addressed but messages.
- ▶ Every message is characterized by its name (Identifier).
- ▶ The less the identifier, the higher the message priority.
- ▶ A message can transport up to  $8 * 8 \text{ Bit} = 64 \text{ Bit}$  (8 Byte) user data, whereas each message requires 110 Bit or 130 Bit (Extended ID).
- ▶ Depending on the hardware and the bus line length, up to 1 MBit/ s can be transferred.

### The following important conclusions result from the properties above:

- ▶ The less the bus load, the less the probability of a "Bus access conflict" (you can call this a real-time capable area).
- ▶ A high bus load forces stations to loose messages with a high identifier or to send them more slowly. Messages with a high identifier can "get lost".
- ▶ Not sent messages are only registered by the "Recipient node" because data are missing. If no timeout has been defined, the last valid value is generally sent, i.e. a mistakenly constant value.

## Transfer rate, Bus line length

The CAN bus supports a max. transfer rate of 1 MBit/s according to Norm ISO 11898-2.

This value is limited in practice by the following points:

- ▶ the bus line length
- ▶ the branch line length to the CAN stations
- ▶ the bus lines quality and the plug contacts
- ▶ the bus line design (twisted, single or two-wire bus)
- ▶ bus connection structure and
- ▶ type and strength of external perturbations

### Example

Data rate on the bus	1 MBit/s = 1 $\mu$ s/Bit
Data length of a CAN message	130 Bits total
User data in a message	64 Bit = 4 values with 16 Bit resolution each
Time for a CAN message	130 Bit x 1 $\mu$ s/Bit = 130 $\mu$ s/message i.e. 4 values require 130 $\mu$ s
Calculating the total sampling rate	130 $\mu$ s match 7.69 kHz
Converted to one channel	4 x 7.69 kHz = 30.76 kHz
Theoretical transfer rate	30 channels with 1 kHz = 30 kHz
Practical experiences	26 channels with 1 kHz = 26 kHz (The value is lower at guaranteed synchronicity.)

If CAN messages are not completely used (e.g. only three 16 bit values instead of four per message), less data can be transferred although the sum sampling rate has not yet reached the maximum. This also applies if different sampling rates are defined in one system, because the data division to the CAN messages is not time-optimized (minimum time required).

## 2.3 Ampacity and voltage drop

Besides the fact that the max. bus line length is defined by the desired data transfer rate, the ampacity and the voltage drop in the system have primarily to be checked. This is especially important for systems with a high number of devices and/or long connections lines of the devices (e.g. distributed systems with connection lines of 3 m (9.84 ft) and more between the device groups). Additional actions should be taken accordingly to the situation.

### 2.3.1 Ampacity

The maximum current via the M-CAN system cables (e.g. 620-560.xxx) is 4 A (heat generation by transition resistances of the plug contacts).

The system capacity and therefore the power consumption can approximately be calculated by using the number of devices (including the sensor supply). A direct power acquisition in the real system provides exact values.

We recommend one or several of the following actions if the limit value is exceeded:

- ▶ Increasing the supply voltage of the devices (e.g. 24 V DC power supply or 42 V DC instead of 12 V)
- ▶ Centered voltage supply via T connection or as close as possible to the devices with high power requirements (rather than at the beginning or end of the system chain)
- ▶ Additional system supply via a T connection at a suitable position

### 2.3.2 Voltage drop

Even if the limit value for the ampacity is not reached, long lines in an extensive system can cause perturbations in the acquisition process. This mainly applies to devices at the end of the system chain, because the voltage of the last devices does not exceed the input threshold of 9 V (due to a high voltage drop in the system).

We recommend one or several of the actions mentioned above.

The voltage drop can be calculated by using the following formula:

$$U = R \times I$$

$$R = 2 \times R_{\text{Cable}} [\Omega/\text{m}] \times \text{Length}_{\text{Cable}} [\text{m}]$$

$$I = P_{\text{Devices}} [\text{W}] / U_{\text{Devices}} [\text{V}]$$

For estimating the voltage drop, a resistance of

- > 50 mΩ/m for the M-CAN cables and
- > 35 mΩ/m for the SIM-CAN cables

can be used including the transition resistances of the plug contacts. Systems, which are in the limit range of the voltage drop, should be controlled in individual cases. To do so, our support will be pleased to assist you.

As the power consumption of a device depends on the supply voltage, it is useful to calculate the voltage drop from the chain end to the feeding point. In this case, a minimum voltage of 9 V is set to the last device and the required excitation is calculated. The calculated value should be generously rounded upwards for guaranteeing a safe operation.

Another fact is the variable internal resistance of the input power supplies (low excitation = lower internal resistance).

In practice, this means: If the net excitation decreases (e.g. because of a weak power supply or a high resistivity with long cables), the devices have to readjust to cover the current power requirements. This causes a higher power consumption, which additionally increases the voltage drop.

### 3 Data logger M-LOG, S-LOG, FLEETlog/FLEETlog2, IPElog

#### 3.1 Overview

Device	IPElog2	IPElog	M-LOG V3	FLEETlog2	IPEhub2
Operating system	RTOS 32 (32 bit)	RTOS 32 (32 bit)	RTOS 32 (32 bit)	RTOS 32 (32 bit)	Linux (32 bit)
Processor	Intel ATOM T3805	Intel ATOM T3805	Intel ATOM T3805	LX800	Arm
RAM memory	2 GB	2 GB	2 GB	256 MB	256 MB
Data loggers software	TESTdrive	TESTdrive	TESTdrive	TESTdrive	IPEhub
Removable storage medium	cFast	SSD	cFast	CF	SD
Storage capacity	8/ 16/ 32/ 64	8/ 16/ 32/ 64/ 128	8/ 16/ 32/ 64	8/ 16/ 32	1 / 2 / 4 / 8
<b>Software</b>					
Configuration software	IPEmotion	IPEmotion	IPEmotion	IPEmotion	IPEmotion
No Message Lost (NML)	■	■			
Wake on CAN (WoC)	■	■	■	■	
Wake on LIN (WoL)	■				
Wake on FlexRay (WoFR)					
Wake on SMS (WoSMS)	■	■			
Wake on Real Time (WoRTC)	■	■			
On board scripting					
On board math & logic operations	■	■	■	■	
File formats for data storage	DAT, BIN, AVI, WAV, MDF4.1	DAT, BIN, AVI, WAV, MDF4.1	DAT, BIN, AVI, WAV, MDF4.1	DAT, BIN, AVI, WAV, MDF4.1	HRD
<b>Interfaces</b>					
Ethernet interface to PC	1 GigETH	100 Mbit	100 Mbit	100 Mbit	100 Mbit
USB 2.0 ports	2	2	2	2	
USB 3.0 ports					
Lemo, 9-pin for M-CAN modules	1	1	2	1	1
CAN HS (ISO 11898-2)	■	■	■	■	■
CAN LS (Low Speed)	■	■	■		
CAN FD					
LIN (1.3 & 2.0)	1 ... 6		1 ... 4		
ETH (100 Mbit)	1	2	2		
ETH (1 GigETH)	1				
FlexRay	1 (By extender)	1 (By extender)	1 (By extender)		
Digital I/O	4/4	4/4	4/4	2/2	
COM (serial RS232)	1		2		
Audio input / output	1		1		

Device	IPElog2	IPElog	M-LOG V3	FLEETlog2	IPEhub2
Driver display system	IPEmotion app / openABK	IPEmotion app / openABK	IPEmotion app / openABK	IPEmotion app / openABK	IPEmotion app
Interface option 1	10 CAN + 6 LIN + 2 ETH	12 CAN + 2 ETH	12 CAN	4 CAN	2 CAN
Interface option 2	16 CAN + 2 ETH		8 CAN + 4 LIN		
Interface option 3			8 CAN + 2 ETH		
Interface option 4			6 CAN + 2 LIN + 2 ETH		
Interface option 5			4 CAN + 2 ETH		
Extender boxes	FlexRay-Extender	FlexRay-Extender	FlexRay-Extender , COMgate V3, IPEWiFi		
<b>Protocols and traffic</b>					
CCP / XCP on CAN	■	■	■	■	
J1939	■	■	■	■	
GM-LAN	■	■	■	■	
OBD	■	■	■	■	
WWH-OBD	■	■	■	■	
KWP on CAN	■	■	■	■	
UDS / ODX / PDX	■	■	■	■	
XCPonETH	■	■	■	■	
FlexRay / XCP on FlexRay	■	■	■		
MOST (25 / 150)					
openABK	■	■	■	■	
SOME IP					
FlexRay traffic					
CAN traffic	■	■	■	■	■
LIN traffic	■				
CAN traffic send	■	■	■	■	■
<b>Wireless communication</b>					
GNSS (Global Navigation Satellite System)	20 Hz (GPS)	1 Hz (GPS)	1 Hz (GPS)	1 Hz (GPS)	
Gyro sensor	100 Hz				
WiFi	2.4 GHz (WiFi 802.11 b/g)	2.4 GHz (WiFi 802.11 b/g)	via COMgate V3	2.4 GHz (WiFi 802.11 b/g)	2.4 GHz (WiFi 802.11 (b/g)
Modem	3G (UMTS/HSDPA)	3G (UMTS)	via COMgate V3	3G (UMTS)	
VPN tunnel			via COMgate V3		
IPEcloud / FTP server	■	■	■	■	
<b>Video</b>					
IP-Camera (RTSP protocol)					
USB Video Class (UVC)	■	■	■	■	

### Data transfer range of built-in modems (FLEETlog, IPElog)

- Frequency range                      Quad-Band EGSM 850 / 900 / 1800 / 1900
- Download rate                        HSDPA 7,2 Mbps
- UMTS/HSDPA (WCDMA/FDD) 2100 MHz
- GPRS multi-slot class 12
- Edge multi-slot class 12

## 3.2 Hardware

### 3.2.1 Block diagram

The block diagram shows the basic structure of the logger board.

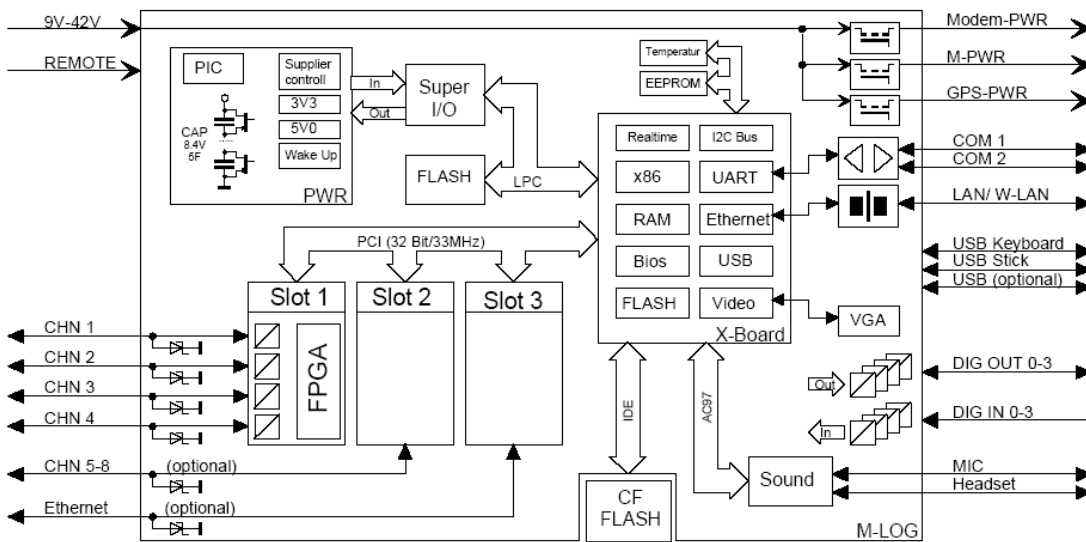

### 3.2.2 Enclosure types



M-LOG with port replicator PR05

S-LOG front view

FLEETlog front and rear view

The M-LOG enclosure is compatible to all M devices. The devices can be easily connected with each other with a dovetail adapter. M-LOG is available with 6 different port replicators (cable connecting adapter). User specific port replicators are available on request.

The FLEETlog2 hardware concept was designed for using the data logger in vehicle fleets, whereas FLEETlog2 WAN is already equipped with modem, WiFi client, and GPS receiver.

### 3.2.3 Port replicators and cables

Various cables are available for every port replicator. The complete PIN configuration, as well as, the appropriate cables of the PR05 and PR08 port replicators are shown in the appendix.



### 3.2.4 Device panel for changing the internal memory card

S-LOG and M-LOG (M-LOG with Upgrade Kit 300) offer a screwed panel for exchanging the cF memory card if required.

The FLEETlog is equipped with a cF card slot behind the folding front panel.

IPElog has a screwless fixed front panel with open/close contact for exchanging the SSD memory card.



*Please note the advice to only change the memory card in exceptional cases because of a possible intrusion of foreign material, dirt or water into the device and the logger could be damaged at removing the cF card. The regular data transfer should be done with the USB stick or the wireless connection (modem or WiFi option).*

### 3.2.5 External fuse for logger protection (IPElog, M-/S-LOG, FLEETlog)



*Depending on the number of inputs, capacitor charge, and connected devices (M or SIM devices, Modem, GPS receiver), the total power consumption (especially at temperatures of  $-40\text{ }^{\circ}\text{C}$  /  $-40\text{ }^{\circ}\text{F}$ ) can reach up to approx. 150 Watt. To protect the total system, we recommend an external overload protection with the following tasks:*

- ▶ Protection of the supply line in error case
- ▶ Overload protection of the current source
- ▶ Logger protection.

We recommend using a **LittleFuse ATO Fuse Fast Acting Type** with a nominal current of 10 A. At using the maximum charge in ambient temperatures under  $-40\text{ }^{\circ}\text{C}$  /  $-40\text{ }^{\circ}\text{F}$ , it can be required to increase the nominal current to 15 A.



*The individual electric circuits (also see M-LOG Port replicators, S-LOG = PR05) are internally protected. The internal resistance of multifuse types increases exponentially and limits the current to a minimum. After clearing the cause of error, the resistance decreases to the normal value (automatic resetting).*

*The motherboard fuse does not work reversibly and must be replaced in the case of a required repair.*

### 3.2.6 Additional short-circuit protection for IPElog and FLEETlog

As the M-CAN connection is not fused by the logger, we recommend to use the cable M-CAN Cable M-CAN/PWR-Fuse (No. 620-677.xxx) in order to prevent the logger from damage caused by a short circuit.

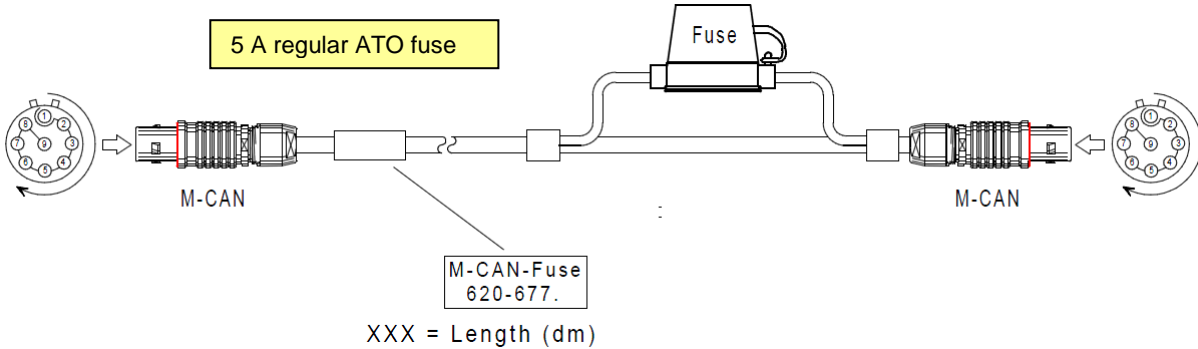

### 3.2.7 LED status display (flashing codes)

LED display	Mode	Meaning
<b>GREEN</b>	Ready or operating	Device is ready (Operation: see yellow LED)
	Warning I Low voltage	The excitation is between 6 V and 9 V. M-LOG shuts down after 2 minutes at unchanged status.
	Warning II Low voltage	The excitation is under 6 V. M-LOG is buffered by the internal supply and normally shuts down.
<b>YELLOW</b>	Measurement running	The logger writes the data to the internal memory.
	Data medium access (post processing)	Prepare file transfer (zip, split)
	Data transfer	Transfer files via USB, modem, or WiFi
<b>RED</b>	Error, Emergency operation	e.g. at invalid configuration, at less memory capacity, at emergency shut-down due to less excitation A restart is required..

### 3.2.8 Power-down at excitation loss

M-LOG, S-LOG, FLEETlog and IPElog are equipped with high-powered capacitors, which guarantee a short excitation in the case of an excitation loss for regularly shutting the system down without data loss. The storage capacity of the capacitors depends on several points (e.g. ambient temperature, aging, charge condition). A data loss can therefore not completely be excluded in the case of a total excitation loss.

M or SIM devices, which are supplied by M-/S-LOG, FLEETlog C2 or IPElog, are immediately switched-off at excitation loss.



*We recommend to revise the switching and the buffer capacitors every 2 years for guaranteeing a clean functionality. The device calibration every 2 years includes this revision.*



### 3.3 Initial start-up

#### 3.3.1 Connecting the logger

- ▶ Connect the red socket using the Power/Remote cable (e.g. 620-574.xxx) with an appropriate power supply (9 V<sub>DC</sub> ... 36 V<sub>DC</sub>)
  - PWR+ = Voltage supply Plus
  - GND = Voltage supply Minus
  - REM = Ignition line 15 or power supply Plus via switch
  - Shield = Shield or voltage supply Minus

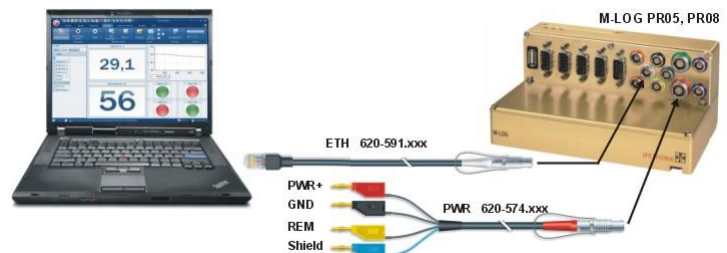

- ▶ Connect the white socket using the LAN cable (e.g. 620-591.xxx) with the Ethernet interface of a PCs/Notebook, resp. using the LAN cable (e.g. 620-355.xx) for connection to a network.
- ▶ Switch on the logger
  - REM = Ignition line 15 or power supply Plus via switch
  - green status LED lights continuously
- ▶ Logger starts up and will enter the measurement mode after a short time.
  - yellow status LED lights continuously
- ▶ Refer to the **Flow chart of the measuring process** in the appendix for more details.

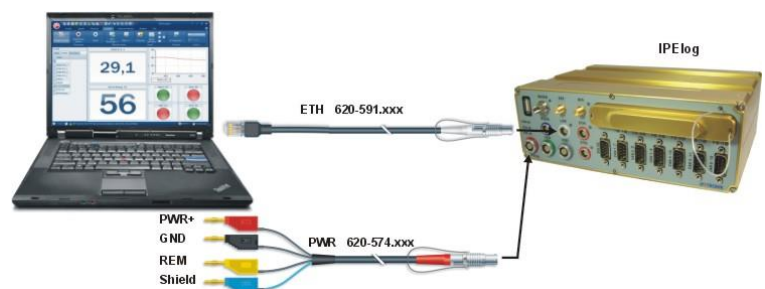
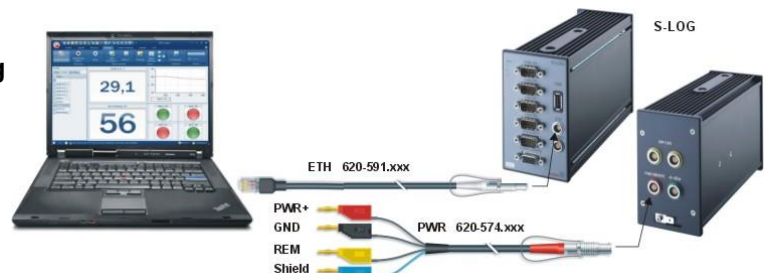
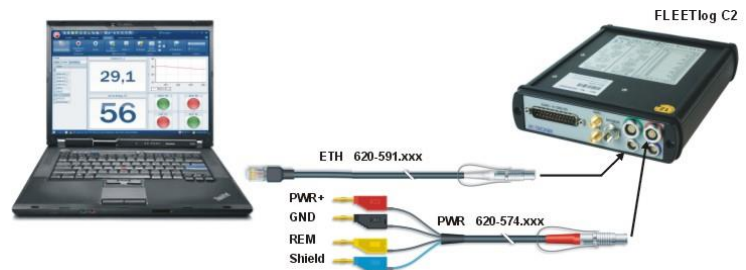

#### Useful notes

- ! If the Ethernet connection to the logger will not work properly, at first transfer the correct IP settings to the logger using a USB stick. Refer to **Add logger system, creating test configuration (USB stick)**.
- ! Using the cable **620-591.xxx LOG Cable ETHERNET (crosslink)** is a point-to-point connection between logger and PC. A fixed IP address is required for both. Refer to **Static and dynamic IP addresses**.
- ! When connecting the logger and the PC used for configuration and data acquisition to a network with DHCP server, both have to be set to dynamic IP address, in order to receive the individual IP address by the DHCP server automatically.  
In this case use cable **620-355.xxx M-LOG PR05 ETH Cable RJ45**.

Please consider the risk of IP conflicts (same IP address may exist twice), if you use static IP address settings when connected to a network with DHCP support.

### 3.3.2 Detecting the logger, creating test configuration (Ethernet)

- ▶ Start IPEmotion at your PC/Notebook.
- ! Using Logger PlugIn version  $\geq 3.50$ , IPEmotion  $\geq 2.0$  is required.

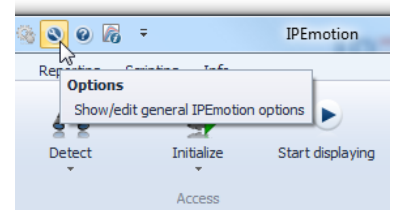

- ▶ Activate the PlugIn IPETRONIK-LOG.

**Options > PlugIns > IPETRONIK LOG**

- ! The PlugIn IPETRONIK-LOG version 3.50 and higher requires TESTdrive  $\geq 3.50$  on the logger. Please update the logger application if necessary!

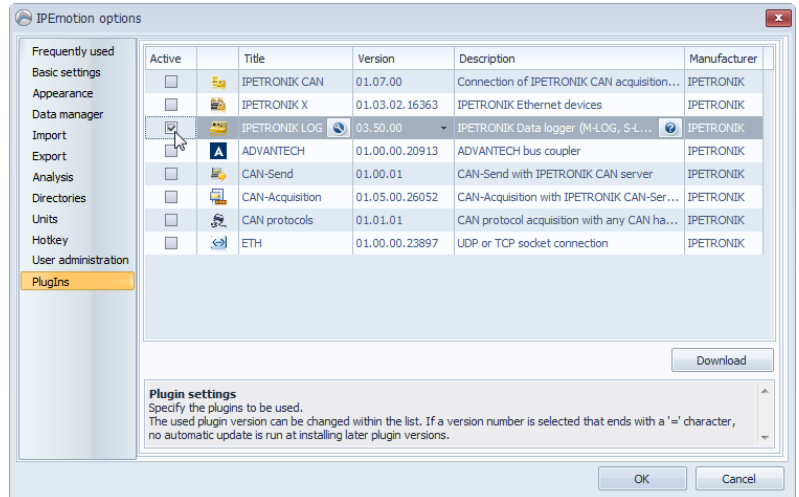

- ▶ Select the main tab **Signals**.
- ▶ Click **Detect** to identify the connected hardware components.  
The / all available logger(s) will be displayed in a select list.  
Confirm your selection by activating the corresponding checkbox and click OK. The configuration settings stored on the logger will be readout and displayed.

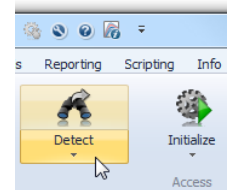

- ▶ Activate the status signal CPU load.  
 > Mark the logger at the left hand structure top area and scroll the signal list downwards to CPU load, hook **Active** to enable the checkbox.

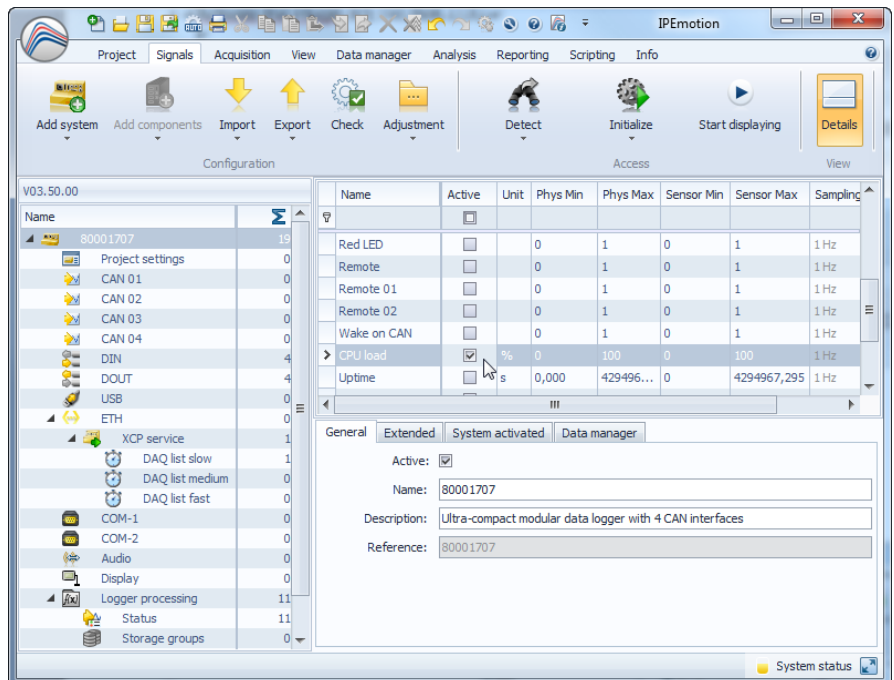

- ▶ Select **ETH** from the left hand tree structure, right click and choose > **Add components** > **XCP service** from the context menu
- ▶ Select **DAQ list slow** from the left hand tree structure, right click and choose > **Add components** > **Channels** from the context menu
- ▶ Mark **CPU load** and confirm by clicking **OK**.
- ▶ Mark the logger from the left hand tree structure top area. Click **Start displaying** from the tool bar.
- ▶ Once the logger has been initialized, the current value of the CPU load is displayed continuously in the signal list. Now logger's ETH communication test and online data streaming via XCP service has been completed successfully.

### 3.3.3 Add logger system, creating test configuration (USB stick)

In case the data acquisition or the Ethernet connection is not working properly (e.g. when using obsolete / former configurations, incompatible IP address settings, ...), we recommend to transfer a valid (already successfully tested configuration) per USB stick to the logger.

- ▶ Create a logger system:  
Select from the main tabs  
**Signals > Add system > e.g. M-LOG (4CAN)**
- ▶ Enter the front number of the logger you will use:  
> Mark the logger at the left hand structure top area and choose the **Extended** tab to set the last four digits of the logger's serial number using the field **Front number**.
- ▶ Select the **Data manager** tab and activate the check box **Update connection parameters** and click to **Configuration**

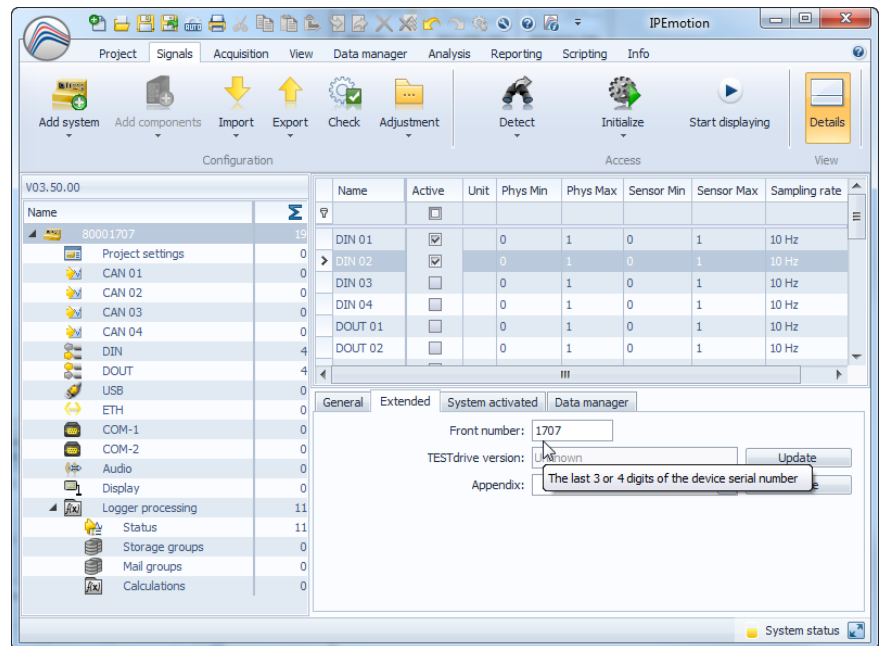

- ▶ Enter valid settings for the IP address used for the Ethernet connection (auto IP or fixed IP) as described at **Static and dynamic IP addresses**.
- ▶ Create a test configuration.
- ▶ Save the current configuration settings in the project (\*.icf).
- ▶ Export the project as measurement configuration (TSTdrive.mcf) to an individual subdirectory located on your Notebook/PC or direct to an USB stick.
- ▶ Unplug the USB stick from the configuration PC.
- ▶ Switch on the logger.
- ▶ Plug in the USB stick while the logger is running in measurement mode (yellow LED lights). The logger will stop measurement and start data postprocessing, existing data will be moved to the USB stick. This process lasts as long as the yellow LED is flashing.
- ▶ Then the logger will search for a new measurement configuration on the USB stick. If a new configuration is found, the application on the logger will be updated and the origin TSTdrive.mcf on the USB stick is deleted.
- ▶ Wait until the yellow LED lights nor flashes not any longer and unplug the stick. The logger will switch to measurement operation again.



After all necessary connection parameters have been updated with valid settings (logger, PC), a communication via the LAN cable is supported, including these actions:

- ▶ transfer a new configuration to the logger,
- ▶ detect the logger and read the configuration from the logger,
- ▶ transfer measurement data from the logger to the PC (import measurement files).

### 3.3.4 Static and dynamic IP addresses

Basically IPETRONIK data loggers can be connected to other network clients via Ethernet in two different ways:

- ▶ Point to point connection between the logger and the PC/Notebook. Usually neither the logger nor the PC/Notebook supports DHCP (Dynamic Host Configuration Protocol), it is necessary to set a fixed IP address for both.
- ▶ Client to client connection between logger and PC/Notebook through a local network. In this case the network server provides DHCP and manages the automatic IP address assignment to all network clients. Therefore logger and PC have to use dynamic IP address settings.

Use the **Data manager** tab to enter the settings for the logger:

- ▶ Mark the logger at the left hand tree structure top area.
- ▶ Select the **Data manager** tab from the right hand down area (configuration tabs) and activate the check box **Update connection parameters**.
- ▶ Click **Configuration**.
- ▶ Choose the tab **Medium selection** and activate **LAN**.
- ▶ Refer to the dialogs below for dynamic (Get IP address automatically) and static IP address settings.
- ▶ When using the static IP address with the logger, it is necessary to adapt the system control settings of the PC/Notebook,

For example:  
 IP address: 192.168.0.100  
 Subnet mask: 255.255.255.0

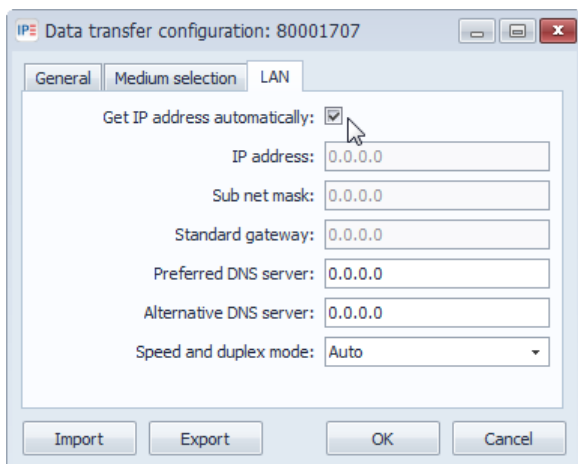
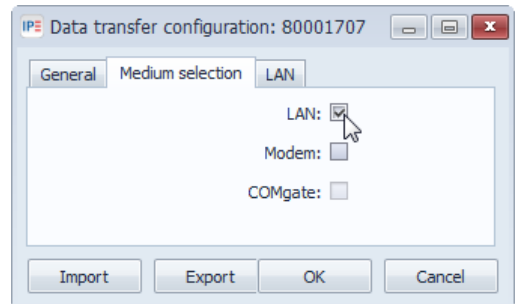
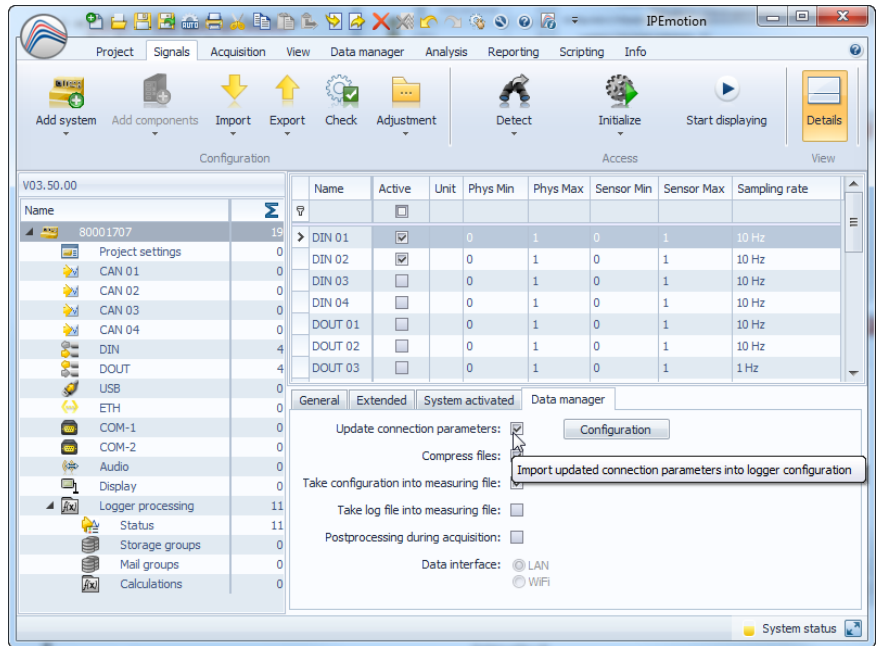

Settings for dynamic IP address

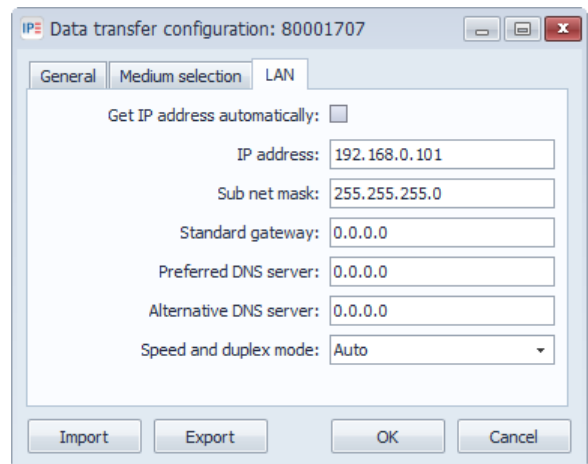

Settings for static IP address

### 3.3.5 Logger web interface for status and signal monitoring

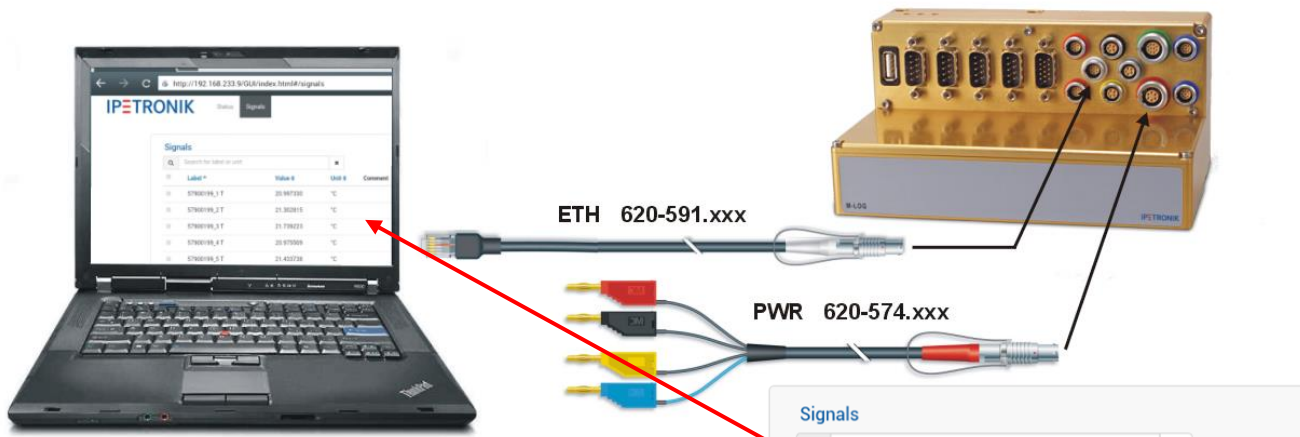

The logger service web site provides status information, the log file and a listing of all measured signals. An extra configuration by IPEmotion is not necessary. To start the site web just enter the logger IP address in the URL command line. The individual IP address of the logger is available from the ETH interface settings in the system structure of the logger configuration

Signals			
<input type="text" value="Search for label or unit"/>			
Label	Value	Unit	Comment
57900199_1 T	20.997330	°C	
57900199_2 T	21.302815	°C	
57900199_3 T	21.739223	°C	
57900199_4 T	20.975509	°C	
57900199_5 T	21.433738	°C	
57900199_6 T	NoValue	°C	

Please also refer to Fehler! Verweisquelle konnte nicht gefunden werden. Fehler! Verweisquelle konnte nicht gefunden werden.

Using the logger system with IPEhub2 and a mobile device (smartphone, tablet) or PC with WiFi port, a wireless access to the status web site and a user specific measurement data visualization is supported.

Refer to **9.2 IPEconnect (Online display with Smartphone or tablet)** for details

### 3.3.6 Logger system with CAN modules

All IPETRONIK CAN modules (M-Series, SIM-Series, CANpressure, MultiDAQ, High Voltage Iso DAQ ...) are connected to the data logger with corresponding system cables.

#### Connecting the modules

- ▶ Daisy-chain the modules among one another and connect the system with its respective cable to the logger.
- ▶ The end of the module chain has to be terminated with a termination plug.
- ▶ Using M-LOG or S-LOG the 2nd CAN bus socket has to be terminated also > use M-CAN or SIM-CAN termination plug.

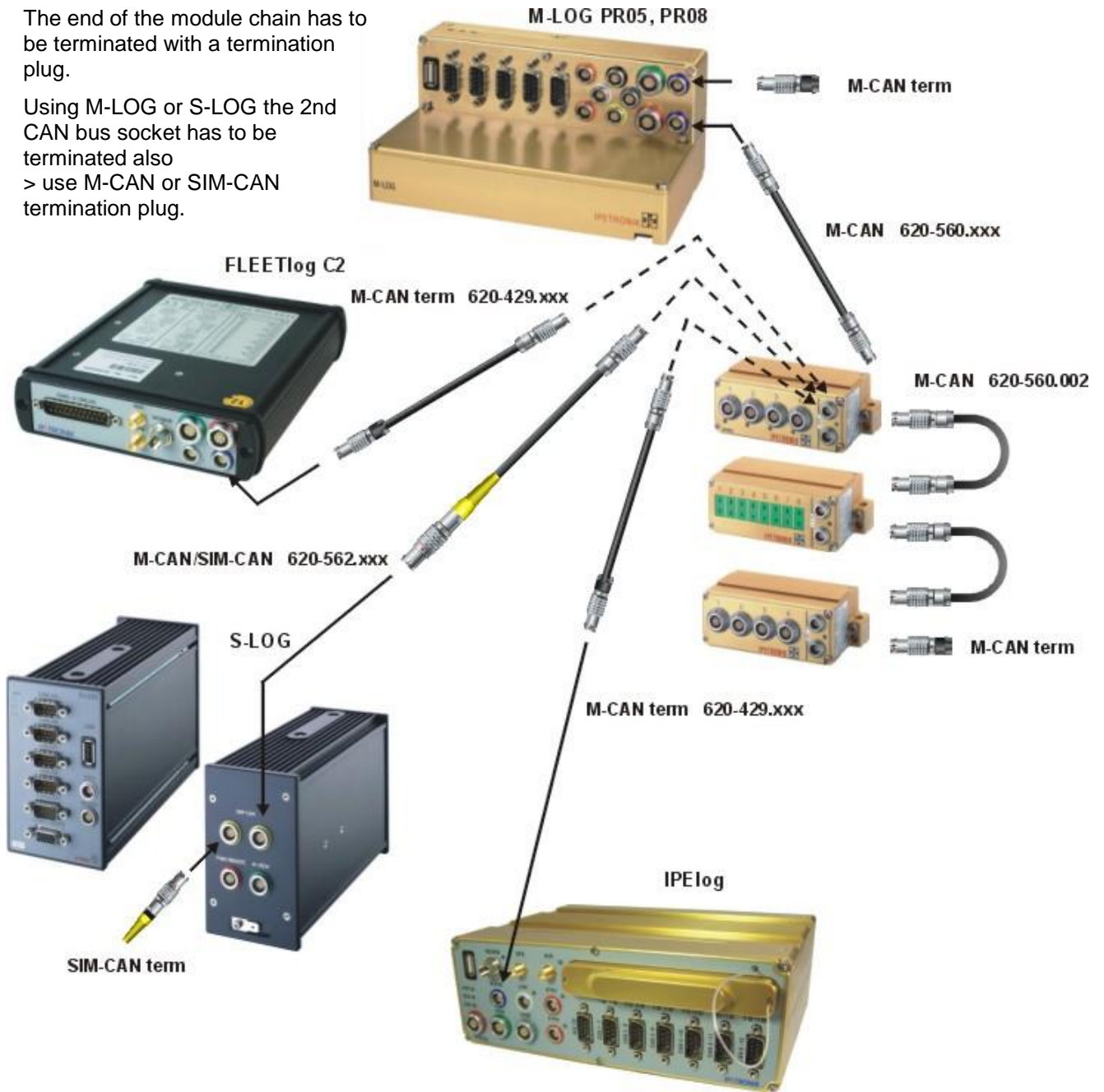

Usually all IPETRONIK CAN modules are connected to the logger through the system connectors M-CAN resp. SIM-CAN with S-LOG. Thus they can be detected and configured by IPEmotion in a user-friendly way. Besides this, it is also possible to connect IPETRONIK modules, as well as, non-IPETRONIK CAN modules to a free CAN measurement input. Please note, that you need a separate cable to supply the modules with power for this. Configuration of the modules is done manually or by importing a CANdb file.

## Detecting modules, creating test configuration

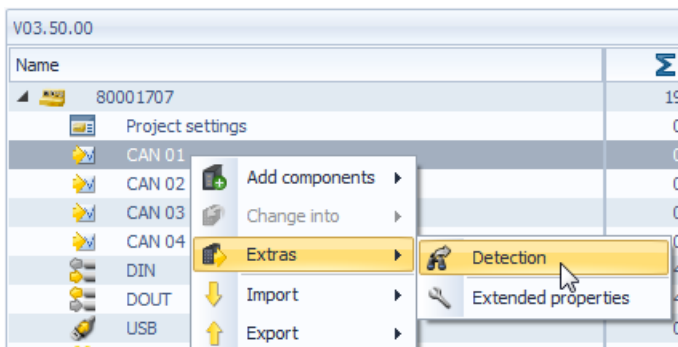

1. Select the CAN input to which the devices are connected to (CAN 01 is recommended because it is connected with the M-CAN or SIM-CAN socket at the logger).
2. Select **Extras** from the context menu (right mouse button).
3. Select **Detection** to detect the connected devices and to transfer the current settings to the configuration.

**MultiDAQ is detected as IPETRONIK CAN device from TESTdrive V03.22!**

- ▶ Execute **Detection** of connected modules as described.
- ▶ Configure the modules and the logger (activate channels, set signal scaling, select sample rates, create storage groups, ...)
- ▶ Save the current project.
- ▶ Initialize the Logger (working Ethernet connection required) or transfer the configuration per USB stick to the logger.



To display measurement data acquired by the logger using the Ethernet connection, you have to add an **XCP service** at first. Assign all signals to the DAQ lists of the XCP service which you want to be displayed.

The **Options** setting **Automatic service administration** will automatically create an XCP service and assign all active signals to the DAQ lists.

### 3.3.7 Access to data stored on the logger

The logger stores all data in a Zip archive on internal storage medium (cF card, resp. SD card with IPElog).

MEA\_xxxx.zip            measurement data + header file + current configuration

LOG\_xxxx.zip            logfile with status reports of the data acquisition



A measurement file (archiv file) is empty, if the sum of the file contents calculated from the files listed below is 0. In this case, the respective zip archive will be deleted.

- all files containing storage groups except the DAT files
- all trace files (BD...)
- all statistic files except the DAT files
- Min/Max statistic file (STG)
- Audio/Video files except the DAT files (AVI, WAV, IMG)
- Traffic files (BIN, Quickstart)
- LOG file
- Measurement status file
- PPP debug file (PPP...)

Access (= data transfer to a PC or FTP server) to data stored on the logger is supported:

- ▶ per USB stick
- ▶ through an Ethernet cable connection
- ▶ using COMgate or an internal/external WiFi client
- ▶ using COMgate WAN or an internal/external modem

## Using a LAN cable connection

Import measurement files / log files

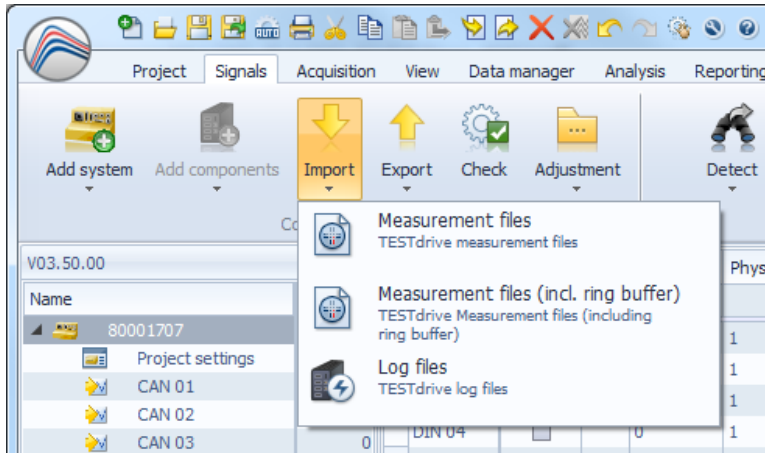

1. Select **Signals** navigation tab.
2. Select logger in the left **Systems** overview.
3. Transfer the current data (internal memory) in the **Signals** navigation tab to PC with **Import > Measurement files**.
4. Transfer the current data (internal memory + pre-/post-trigger data) in the **Signals** navigation tab to PC with **Import > Measurement files (incl. ring buffer)**.
5. Transfer the current TESTdrive log files in the **Signals** navigation tab to PC with **Import > Log files**.
6. Select the target directory or crate a new folder to save the respective data.

## With USB stick

Plug in the USB stick to the running logger. The logger stops data acquisition, saves data, log files and the related configuration to the stick. If the yellow LED is not permanently on, disconnect the USB stick. The logger runs now in acquisition mode..



*Please note that data can only be imported via USB if no LAN connection to the logger is activated. Disconnect the logger with the logger context menu.*

### 3.3.8 Synchronizing the logger time

- ▶ Mark the logger at the left hand structure top area.
- ▶ Right click to the logger entry and select **Extras > Synchronize logger time** from the context menu.

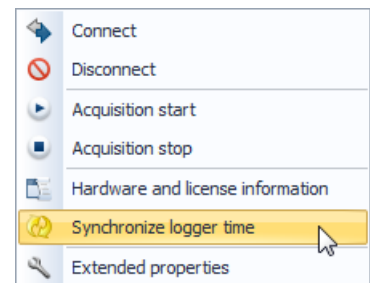

*Time data of time stamp and log messages have been normalized. Now time stamp output is local time (former UTC). Time stamps reported in XML files always indicate the offset (time lag) to UTC time, e.g. <startdate>2012-04-25T09:30:10+01:00</startdate>*

*In order to ensure a correct time interpretation of recorded data, the IPETRONIK data converter IPEconverter V02.13 is required.*

### 3.3.9 Readout Hardware and license information

#### Using the Ethernet connection (LOG2PC)

- ▶ Select the data logger on the top left area.
- ▶ Select **Extras > Hardware and license information** from the context menu by right-clicking.

#### Hardware and license information file (hw\_descr.xml)

- ▶ Select the data logger on the top left area.



- ▶ Select **Extras > Hardware and license information from file** from the context menu by right-clicking.
- ▶ Look for the file **hw\_descr.xml** locally or on a USB stick.



*Plug a USB stick into the running data logger to retrieve the license file (together with configuration and acquisition data). Unplug the USB stick from the logger and plug it into a PC. Go to the directory named with the logger's serial number, then go to the **DEVICE** subdirectory. The zip file TSTdrive contains the hardware/license file **hw\_descr.xml**.*

### 3.3.10 Updating the measurement application (TESTdrive) per USB stick

#### Measurement application TESTdrive

- ▶ Copy the file **MLogger.rtb** (standard, inclosed in the TESTdrive\_xxx.zip) or **Logger.prg** (for M-VIEWgraph, inclosed in the Setup\_xxx.exe of the respective PlugIn) to the subdirectory named with the logger's serial number on the USB stick.
- ▶ Power up the logger and wait for the yellow LED which indicates data acquisition.
- ▶ Plug in the USB stick to the logger, program update will start automatically.
- ▶ Wait until the yellow LED lights no longer and unplug the USB. The logger executes a reboot and starts measuring operation with the new application.

#### Measurement configuration (logger specific)

- ▶ Copy the file **TSTdrive.mcf** to the subdirectory named with the logger's serial number on the USB stick.
- ▶ Power up the logger and wait for the yellow LED which indicates data acquisition.
- ▶ Plug in the USB stick to the logger, configuration update will start automatically. As soon as the update has been completed successfully, the TSTdrive.mcf will be deleted from the USB stick.
- ▶ Wait until the yellow LED lights no longer and unplug the USB.

#### Measurement configuration (single USB stick used for different loggers)

- ▶ Copy the file **TSTdrive.mcf** to the root directory on the USB stick.
- ▶ Power up the logger and wait for the yellow LED which indicates data acquisition.
- ▶ Plug in the USB stick to the logger, configuration update will start automatically. The TSTdrive.mcf will remain on the USB stick, whether the update has been completed successfully or not.
- ▶ Wait until the yellow LED lights no longer and unplug the USB.
- ▶ Repeat this procedure for any other logger update relating to this configuration

#### Serial number specific update

When updating via USB/FTP, the system checks, if the file name consists of a 8 digit serial number. Update is executed when the serial number matches with the logger, the file is deleted from the source directory afterwards. In case of mismatch, the latest valid file is used. Files with invalid serial numbers will remain in the source directory.

When the file contains no serial number information, the standard update process is executed (equal to previous TESTdrive versions).

### 3.3.11 TESTdriveCMD.xml

The file TESTdriveCMD.xml controls user access of the logger. If the restriction has been activated, the logger searches for the TESTdrivecmd.xml at the root directory of the USB stick. Measurement will not be started when the file is missing.

Activate the use of the TESTdrive commands at IPEmotion **Options > Plugins > IPETRONIK LOG >**

**Settings**  **> Options > Activate TESTdrive access restriction.**

The following templates are located at:

...IPETRONIK\IPEmotion PlugIn IPETRONIK  
LOGV03.xx.00\Data\TESTdriveCMD\[language]

#### Guest (directory „guest“)

- ▶ Copy data
- ▶ External storage

#### User (directory „user“)

- ▶ Update measurement configuration
- ▶ Update measurement configuration, Copy data
- ▶ Update measurement configuration, Copy data incl. PostMortem
- ▶ Update measurement configuration, Move data
- ▶ Update measurement configuration, Move data, incl. PostMortem
- ▶ Start logger in FTP mode
- ▶ Set the logger's system time

#### Administrator (directory „admin“)

- ▶ Update measurement application
- ▶ Update measurement application, Delete data
- ▶ Update measurement application, Update measurement configuration, move data
- ▶ FPGA update

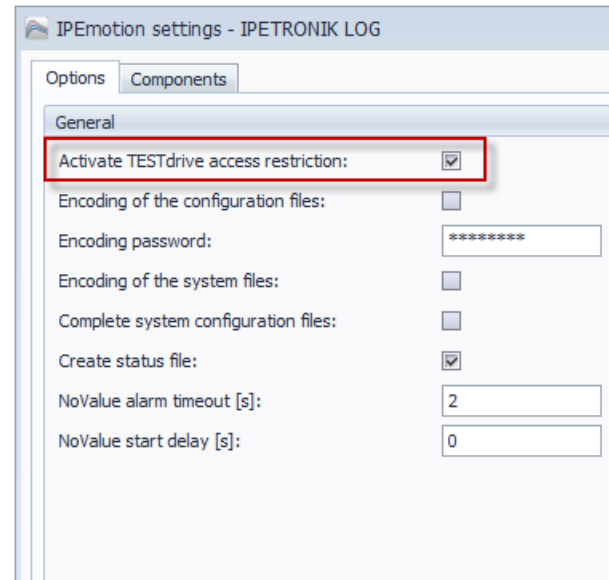

### Parameter of the “dataTransfer” service

#### <meaNumber>

If this parameter has not been defined, all data will be transferred. Valid values of this parameter are "all" (not case sensitive) and a number between 0 and 9999. This parameter can be used multiple times. The applied sequence has no effect on data transmission. The data transfer starts with the measurement data file named with the lowest number in ascending order.

The file TESTdriveCmd.xml will be deleted from the server as soon as it has been transferred successfully. It will be deleted from the local source if all <meaNumber> entries have been processed. The file name prefix "TESTdriveCmd" is required, the file extension has to be "xml". If the file name consists an 8 digit number (e.g. TESTdriveCmd\_12345678.xml) the logger will take this as serial number. The file will accepted only if the serial number from the file name fits to the loggers serial number. If not, the file will be ignored and remains on the FTP server.

The existing parameters <zip>, <crypt>, <split>, <move> and <useTimeDir> will be ignored. They will be considered only if this service is applied by an USB stick. In this case, the TESTdriveCmd.xml remains unchanged, as usual before and it will not be deleted.

**<transfer>**

This parameter controls the data transfer following to the data post processing (zipping, splitting, copying). Valid values are "true" and "false". If the parameter is not configured, its value is set to "true" per default.

"true" Zipped and splitted (if required) files are copied to the USB stick.

"false" No measurement data is copied to the USB stick.

## 4 External connection

### 4.1 Grounding



*It is absolutely necessary to connect the logger case with a suitable ground pin within the overall system. Without this grounding, EMV disturbances and uncontrolled voltage interferences can restrict the measuring process.*

#### 4.1.1 IPElog, M-LOG grounding connection

IPElog and M-LOG provide a grounding tap by a blade terminal. Use a 6.3 mm blade receptacle to connect the grounding tap.



#### 4.1.2 FLEETlog grounding connection

FLEETlog2 has four M4 threaded holes at each side which are used to tighten the mounting brackets. We recommend to use an appropriate ring tongue terminal with one of the side screws for grounding the logger case. A fork tongue terminal can also be used.



## 4.2 PWR / Remote connection

### 4.2.1 PWR/REM cable 620-574

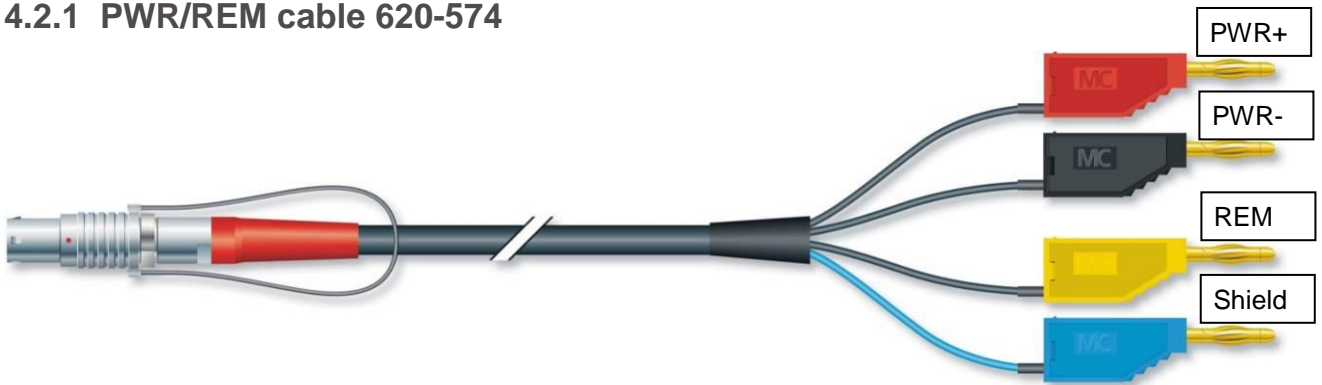

**Always switch on and off the logger using the REM (ignition line 15) connector, never by switching the PWR+ line!**

**Never disconnect the PWR- (GND) line while the logger is running, because this will damage electronic circuits. Switching-on/off the logger via PWR- (GND) is absolutely not allowed!**

### 4.2.2 Remote connection

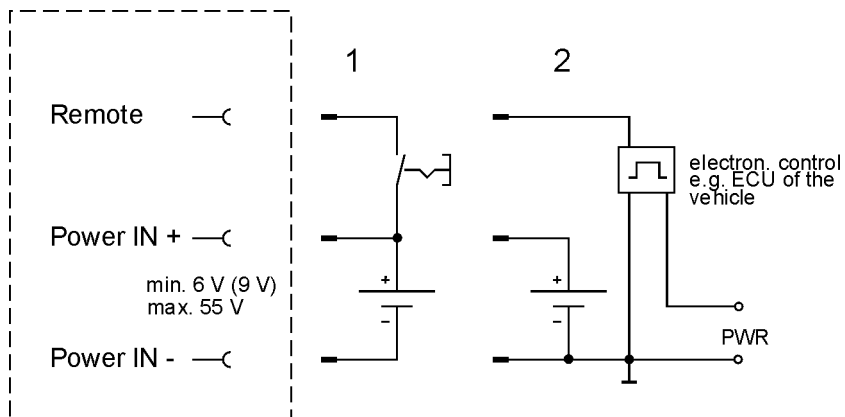

The logger has internal buffer capacitors to avoid a data loss due to sudden voltage losses. The regular shut-down is executed via remote and not by switching-off the excitation!



The activating via a remote impulse (impulse length > 20 ms) is also supported. But the continuous remote signal must be received within 60 s, otherwise the logger is shut down by the watchdog.

**Example:**

Start of measuring system with opening the vehicle door. The continuous remote signal is received at motor start and the system continues measuring. If the continuous signal is not received (no motor start), the logger shuts down after 60 s.

### 4.3 Digital input/output connection

**LOG-PWR** switched logger excitation (not stabilized)  
 The excitation is supplied, as soon as, the logger is activated.

#### 4.3.1 Connecting example digital input

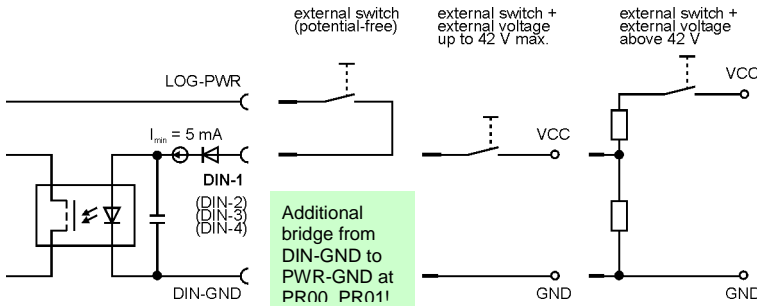

potential free contact with external excitation up to 42 V without any resistor or voltage divider

Terminal 15 of the board electrics (all vehicle power supplies up to 42 V without any resistor or voltage divider)



The digital inputs are electrically isolated but the respective DIN-GNDs are all connected to one PIN of the Sub D socket! This PIN has a direct connection to PWR-IN GND with the PR03, PR04, PR05, PR06 port replicators!

The inputs are protected by an internal 5 mA current limitation.

Required minimum values at the input for a clean functionality:  
 $U_{min} = 3 V$  bzw.  $I_{min} = 2 mA$

#### 4.3.2 Connecting example digital output

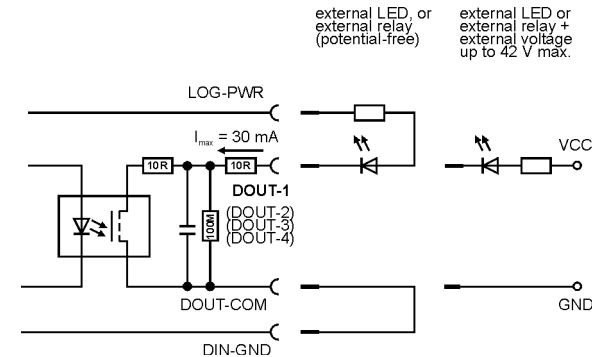

GND (ground) switched  
 $R_i = 20 \Omega$

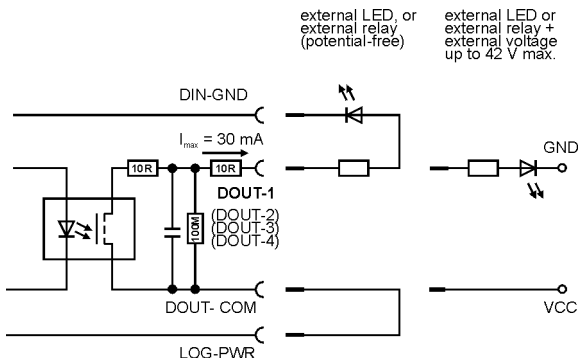

V+ (excitation) switched  
 $R_i = 20 \Omega$



The digital outputs are electrically isolated and can operate bipolarly but the respective COM ports are all connected to one PIN of the Sub D socket!

### 4.3.3 Connecting example external status LED

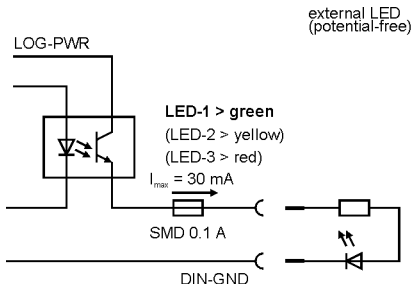

## 4.4 Bus inputs

### 4.4.1 Connecting example CAN bus

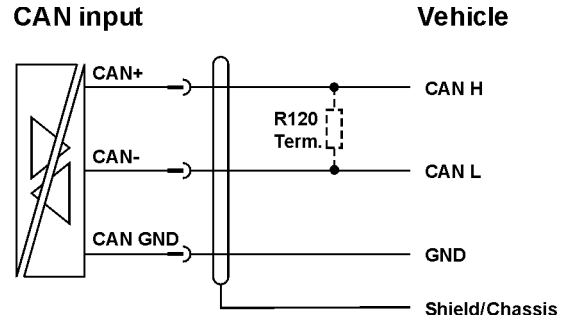

### 4.4.2 Connecting example LIN bus

Due to the galvanic isolation, the transceiver of the LIN measurement input must be power supplied by an external source. This can be:

1. Connection of the vehicle's bus power supply ( $V_{Bsupply}$ ) or
2. Connection of the logger's power supply (bridge from PIN 5 to PIN 1)

#### Variant 1: Connect $V_B$ of the external LIN bus

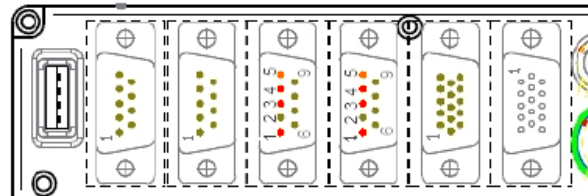
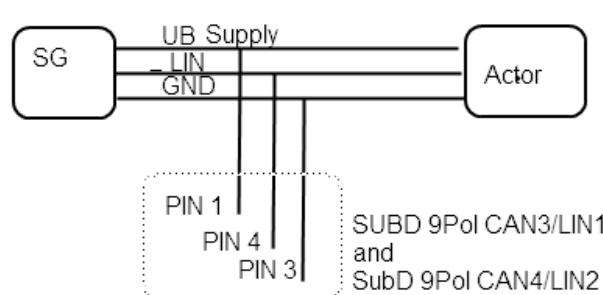

- 1=CAN7-/LIN1-VBATT
- 2=CAN3-L
- 3=CAN3/T-GND//LIN1-GND
- 4=CAN7-H//LIN1-H
- 5=CAN3-LOGPWR
- 6=PW-R-OUT-GND
- 7=CAN3-H
- 8=Option(WaOnCAN)
- 9=UB-OUT+

#### Variant 2: Supply via logger (bridge from PIN 5 to PIN 1)

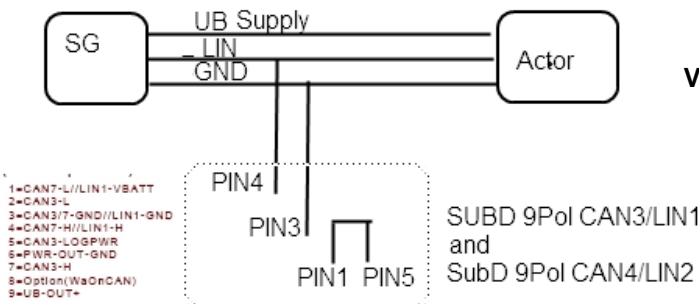

- 1=CAN7-/LIN1-VBATT
- 2=CAN3-L
- 3=CAN3/T-GND//LIN1-GND
- 4=CAN7-H//LIN1-H
- 5=CAN3-LOGPWR
- 6=PW-R-OUT-GND
- 7=CAN3-H
- 8=Option(WaOnCAN)
- 9=UB-OUT+

## 5 Configuration with IPEmotion (extract)

The IPEmotion software is required for configuring a logger measuring system and the corresponding IPETRONIK devices. The software must be installed on the notebook/PC, which is used to configure. (See the instructions in [Commissioning](#)). IPEmotion also supports the online data measurement with using the XCP service. You can find a detailed description of IPEmotion in the manual, which can be opened in the software as a PDF.

### 5.1 First steps

#### 5.1.1 Main dialog

After the start of IPEmotion, the following screen appears.

The screenshot shows the IPEmotion software interface. At the top, there is a menu bar with options: File, Project, Signals, Acquisition, View, Data manager, Analysis, Reporting, Scripting, Info. Below the menu bar is a toolbar with icons for System, Components, Import, Export, Check, Adjust, Detect, Initialize, Display, and Details. The main area is divided into three sections: Configuration, Access, and View. The Configuration section shows a tree view of hardware components, including Project settings, CAN 01-04, DIN, DOUT, USB, ETH, COM-1, COM-2, Audio, Display, Logger processing, Status, and Storage groups. The Access section shows a table of hardware components with columns: Name, Active, Unit, Phys Min, Phys Max, Sensor Min, Sensor Max, and Sampling rate. The View section shows the configuration details for the selected component, DOUT 04, including fields for Name, Description, Reference, and Sampling rate. A message window at the bottom shows a message: "No baudrate was set".

Name	Active	Unit	Phys Min	Phys Max	Sensor Min	Sensor Max	Sampling rate
DIN 01	<input checked="" type="checkbox"/>		0	1	0	1	1 Hz
DIN 02	<input checked="" type="checkbox"/>		0	1	0	1	1 Hz
DIN 03	<input checked="" type="checkbox"/>		0	1	0	1	1 Hz
DIN 04	<input checked="" type="checkbox"/>		0	1	0	1	1 Hz
DOUT 01	<input checked="" type="checkbox"/>		0	1	0	1	1 Hz



*IPEmotion automatically detects all available hardware connections at starting.*





*If you want to reduce the required time, select **Options > Plugins** for deactivating those interfaces, which are not used.*

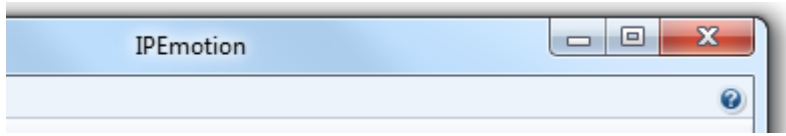

## 5.1.2 The Title Bar

The title bar contains the quick access bar, the software name, as well as, a tool bar with the following functions:



-  Help – Open the documentation IPEmotion.pdf where you can find useful information for a safe and clean application of the software.
-  Minimize – Minimize the application window of IPEmotion and place it in the task bar of your desktop.
-  Maximize – Make the application window visible on your desktop and refit the prior size.
-  Close – Close the application of IPEmotion.

## 5.1.3 The file menu

The file or application menu contains basic functions as: **New**, **Open**, **Save**, **Save As**, **Runtime version**, **Print** and **Close**, as well as, further properties such as **View**, **Options**, **Support file** and **About**.

The right partial view of the application menu contains a list of the recently used projects.

The **View** function contains the menu points **Message window** and the **Reset** command. Show or hide the message window and reset the displaying configuration to the default parameters.

## 5.1.4 Using the options

With the Options entry, you have the ability to edit user defined settings. You can define the following options:

- ▶ Frequently used
- ▶ Basic settings
- ▶ View
- ▶ Data manager
- ▶ Analysis
- ▶ Units
- ▶ PlugIns

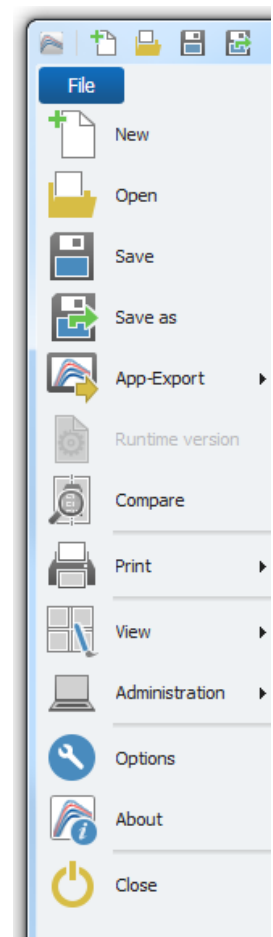

The following section offers you a detailed overview over the available setting options.

## Frequently used

Activate or deactivate **Start with the latest configuration** and define the settings for the **automatic hardware detection**. Activate or deactivate the **automatic hardware detection at start** of IPEmotion and select a possible **standard command after successful detection**:

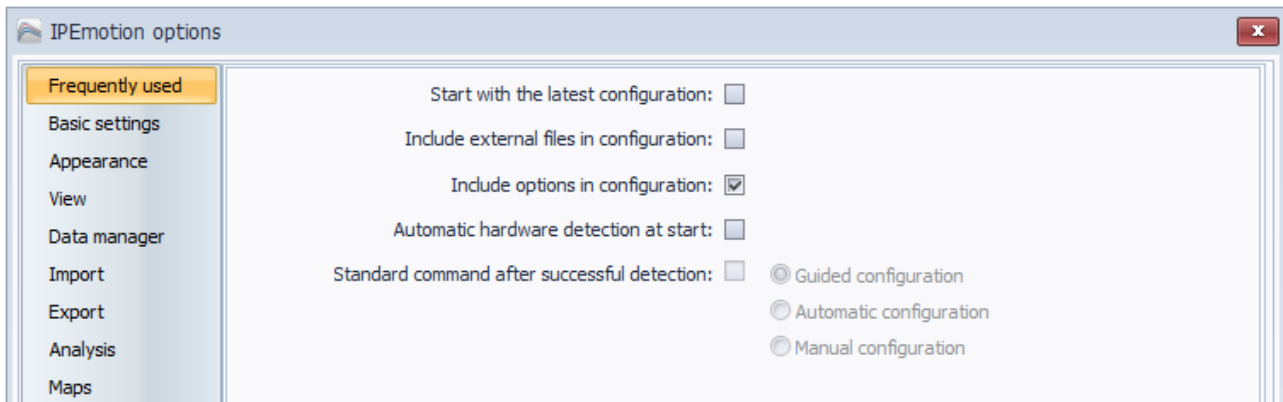

## Basic settings

Select a **preferred configuration type**: Hardware configuration or signals configuration

Activate or deactivate the options: **Accurate acquisition chain required** and **Expert mode**.

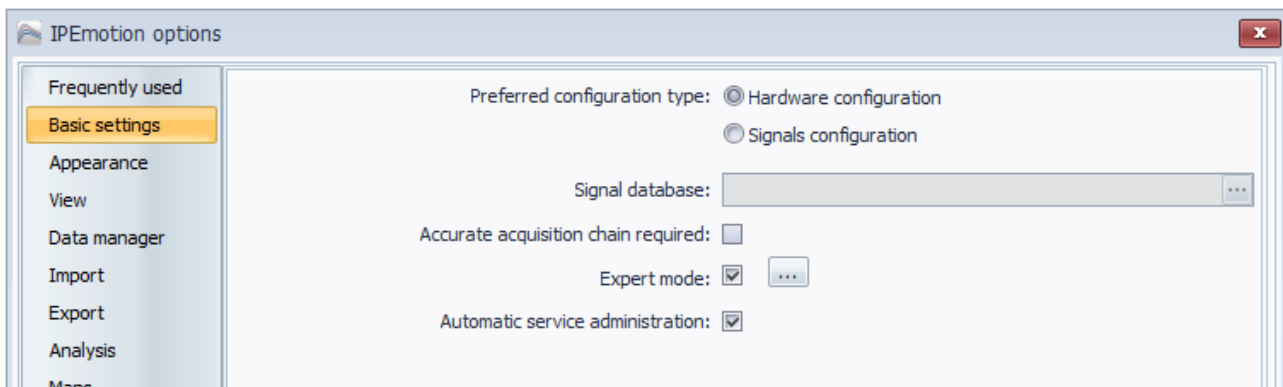

### Expert mode

*The protocol nodes of imported description files (CANdb, A2L, FIBEX,...) are visible, this means, the user has access to the signal properties. With the protocols CCP and XCP the DAQ lists are displayed and can be processed (delete, move signals).*

*With the release of IPEmotion V01.07.00 internal channels (-> Variables) for temporary storage tasks have been implemented. Managing this variables is only supported with an enabled Expert mode.*

Activate the **Automatic service administration** option to automatically import the active channels into the DAQ lists of the XCP service. These channels are then available in online view.



*Please note the restrictions depending on the Ethernet interface of the PC and the number of active channels. In this case, it is recommended to manually import the required channels into the DAQ lists of the XCP service (deactivated Automatic service administration)*

## View

Define your **view settings** according the following listed points:

- Language selection
- Skin selection
- Displaying tooltips
- Font size of the visual elements
- Transparency of configuration dialogs (0 – 30 percent)
- Activate or deactivate the use of the **Windows standard dialogs** for the file and directory selection.

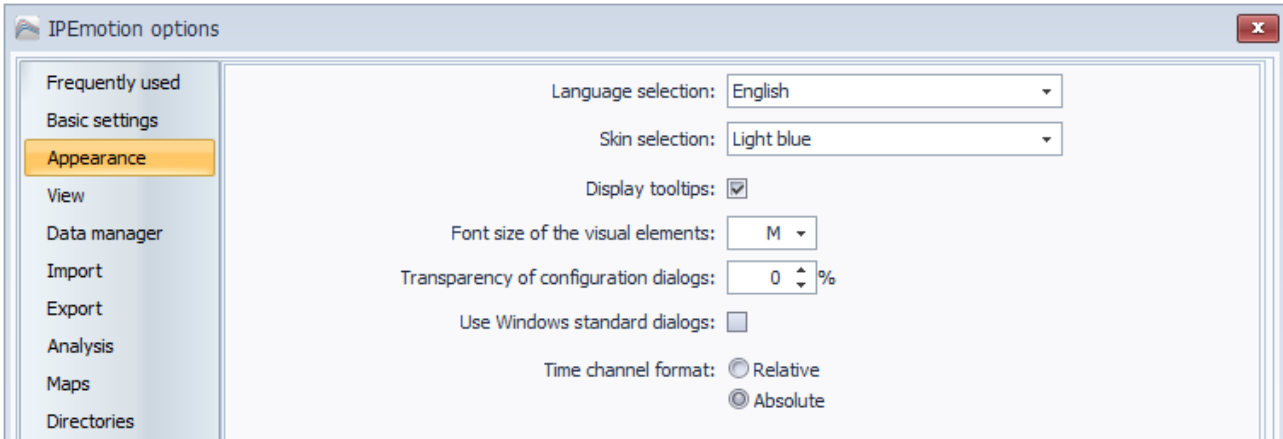

## Data manager

Define the **Time channel format** as *Relative* or *Absolute* (This setting is currently not supported for the export into external formats!) and activate or deactivate the option: **Merge time channels with equal acquisition rate**.

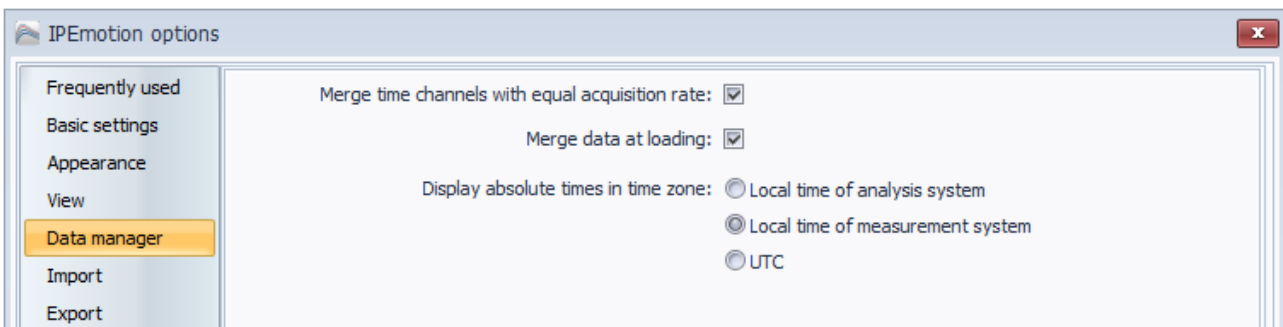

## Analysis

Select the **points per diagram graph**. Define if all signals are considered in the analysis diagrams at drawing the graph or only the samples. Move the bar accordingly to the preferred speed or quality.

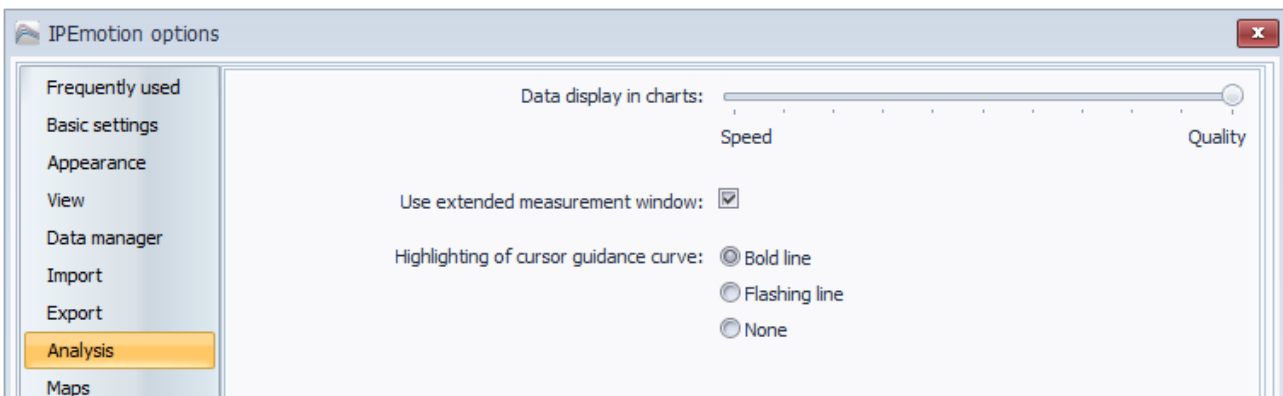

## Units

Get an overview according the common physical values and their respective unit and edit them.

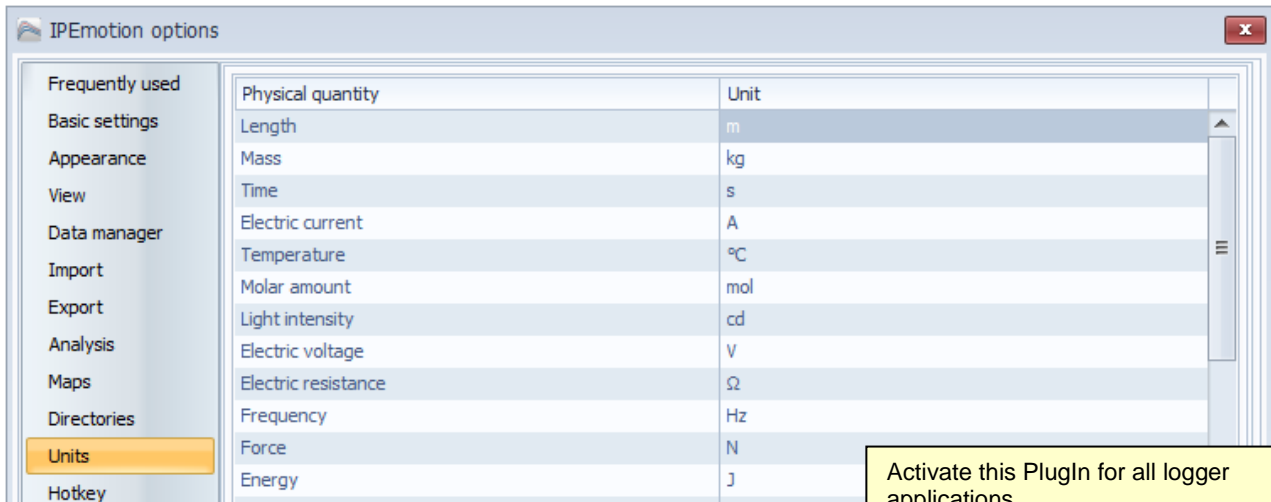

Activate this PlugIn for all logger applications.  
The corresponding TESTdrive version must be available at the logger!

## PlugIns

Activate or deactivate the **hardware systems** to be used.

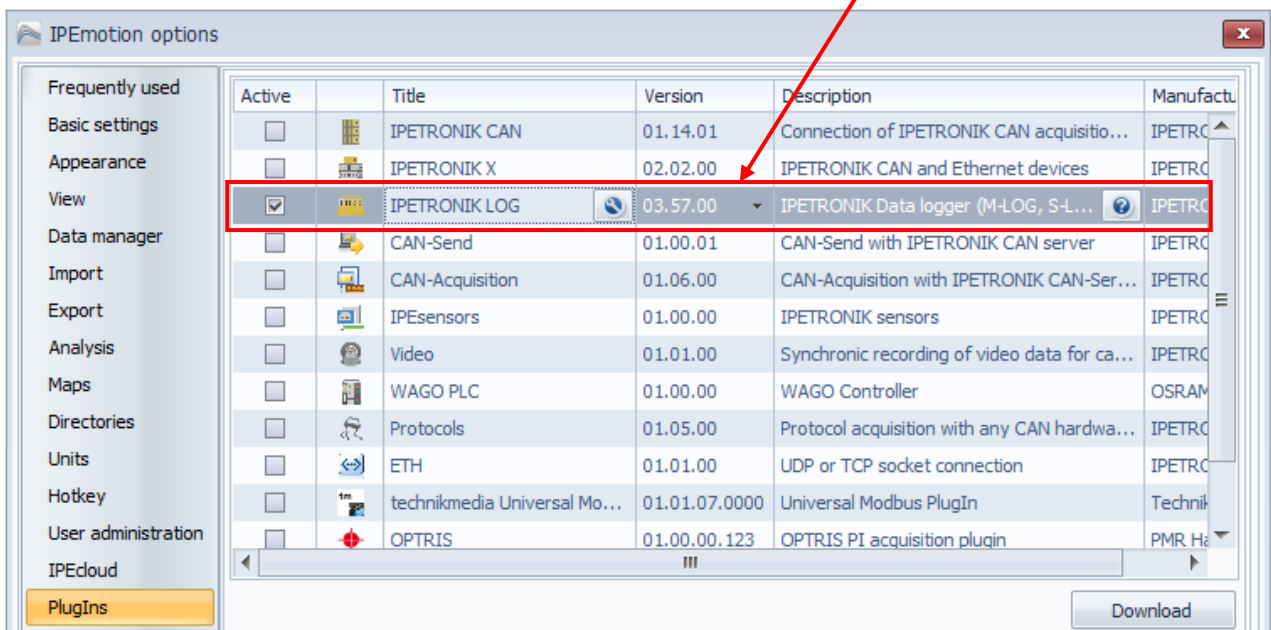

Clicking the wrench symbol  enters the dialog for PlugIn specific settings provided by the tab **Options** and **Components**.

## Components

With the **Settings** button, you have the ability to define the **components** (module type and priority, e.g. for the type selection of the Dry configuration) of the respective hardware system and to edit additional **options** settings.

The selection of the hardware components for the configuration by using a signal library is based on the **Priority**. This preselection with a priority assignation of the system components facilitates the device selection and improves the system speed.

The **High** priority defines a preferred use of the corresponding hardware component at configuring with a signal library. The hardware components, which are defined with the **Not used** priority, cannot be selected for an acquisition.

### Options

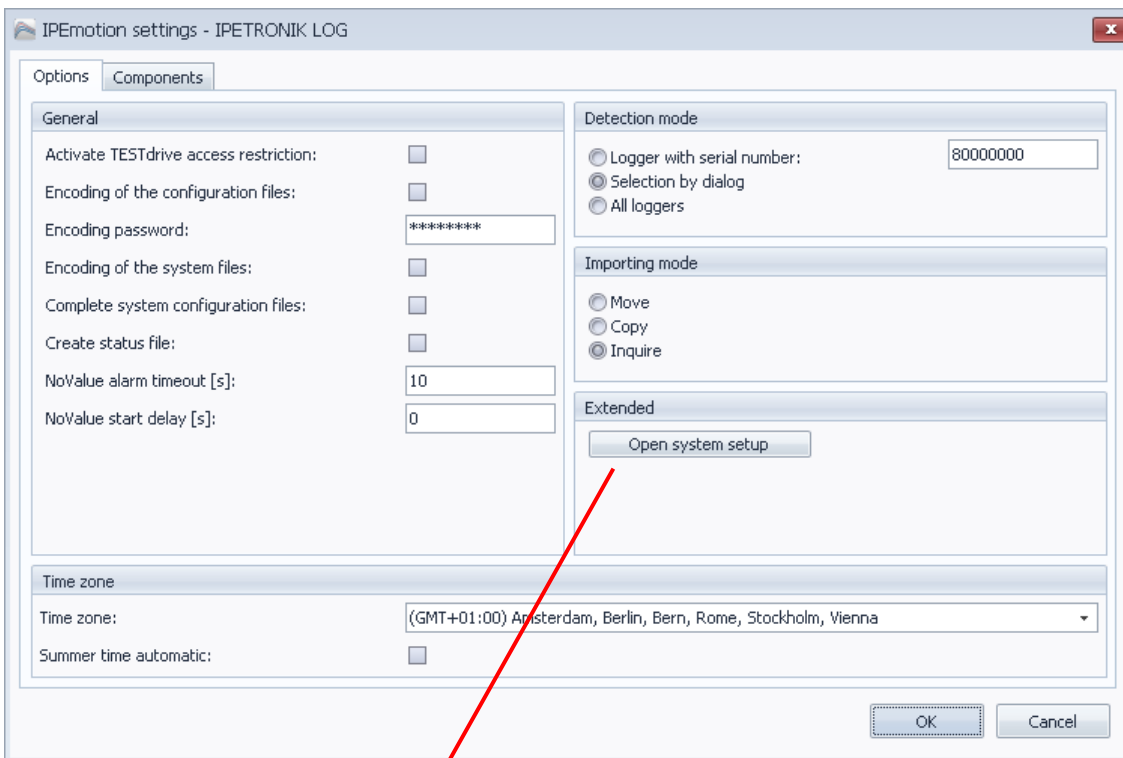

### Extended options

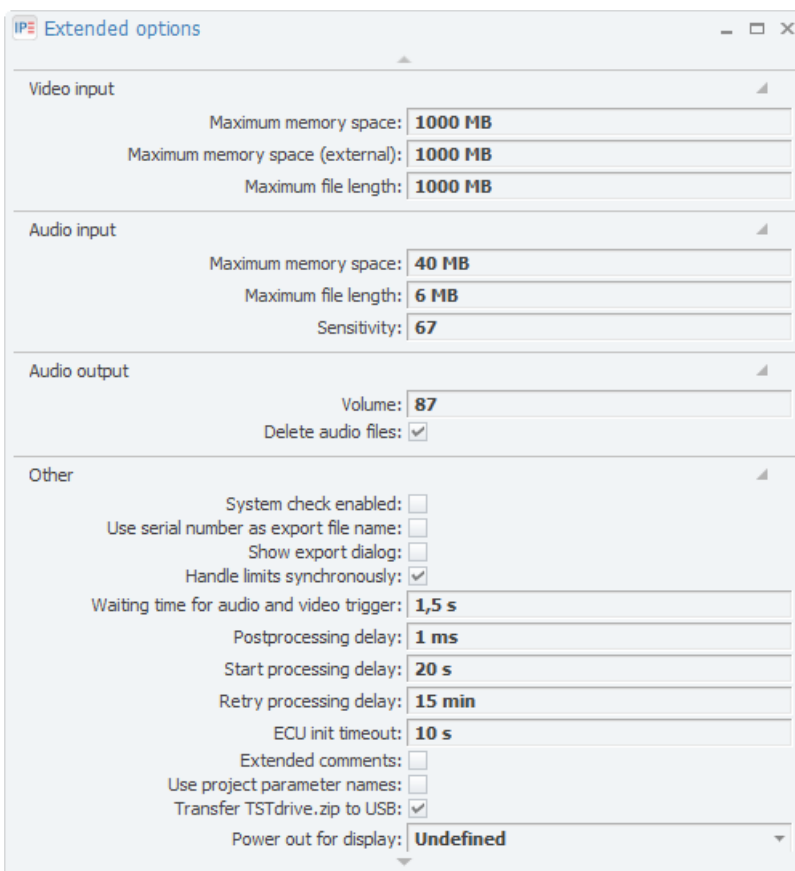

Activating this check box will execute an automatic CAN ID assignment starting with the predefined ID for connected and identified modules.

Data transmission rate settings  
slow: 1 ... 5 Hz  
medium: 10 ... 50 Hz  
fast: 100 ... 1000 Hz

### 5.1.5 Creating a support file

With the **Support file** entry of the application menu, you have the ability to create a support file and add and/or edit own comments and error descriptions.

Enter in the appearing **Create support file** screen an error description. Accept the default location for the file. To select another location click on the  symbol.

After you have specified the location and a user defined file name, click **Save** to return to the **Create support file** screen.

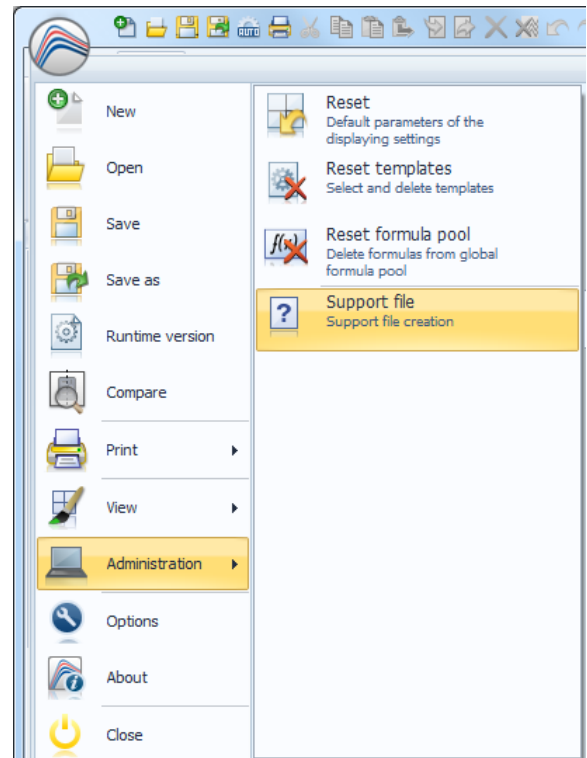
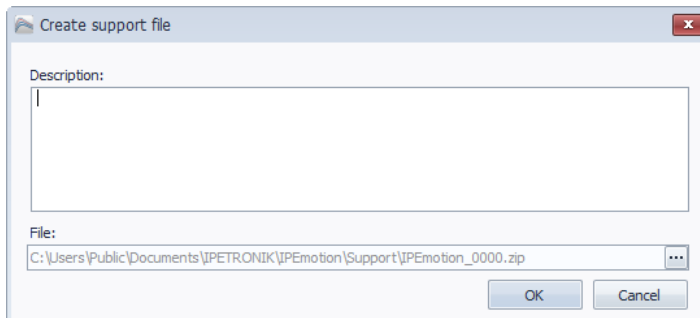

After clicking on **OK** a zip file is generated that contains the error description, as well as, the following information:

- ▶ System information (Windows version, computer name, free memory on the local drives, ...)
- ▶ Current configurations (acquisition, online view, script configurations)
- ▶ Trace files (.NET, C++)

If you have any problems while working with IPEmotion, send us this support file at [support@ipemotion.com](mailto:support@ipemotion.com).

### 5.1.6 IPEmotion working areas (main navigation tabs)

The main navigation tabs allow a quick activation of the different main functions of IPEmotion. A tab displayed in light blue indicates an active function.

IPEmotion is designed to follow the main navigation tabs from left to right. Use this reasonable order like a read thread, which guides you step-by-step to a successful acquisition.

<b>Project</b>	<b>Signals</b>	<b>Acquisition</b>	<b>View</b>	<b>Data manager</b>	<b>Analysis</b>	<b>Reporting</b>	<b>Scripting</b>	<b>Info</b>
----------------	----------------	--------------------	-------------	---------------------	-----------------	------------------	------------------	-------------

- Project** Define your general user defined project data.
- Signals** Configure the connected acquisition systems and modules.
- Acquisition** Configure the desired storage groups and channels.
- View** Take a measurement defined by the connected hardware modules and the set configurations.
- Data manager** Manage your stored acquired data in all the supported formats.
- Analysis** Visualize your channels with diagrams.
- Reporting** Create reports and project documentations.
- Scripting** Automate your acquisition sequences.
- Info** Get a basic overview and general support.

#### Project

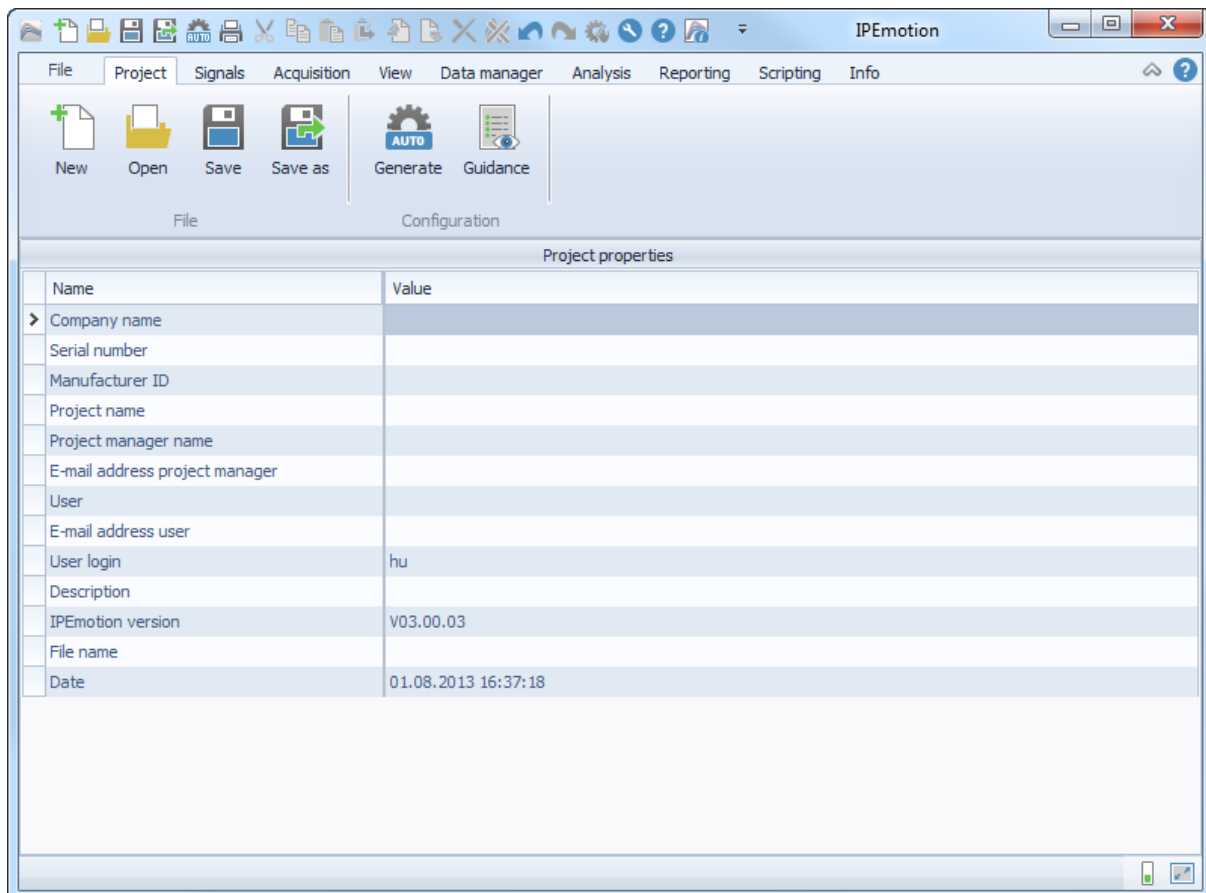



## Signals

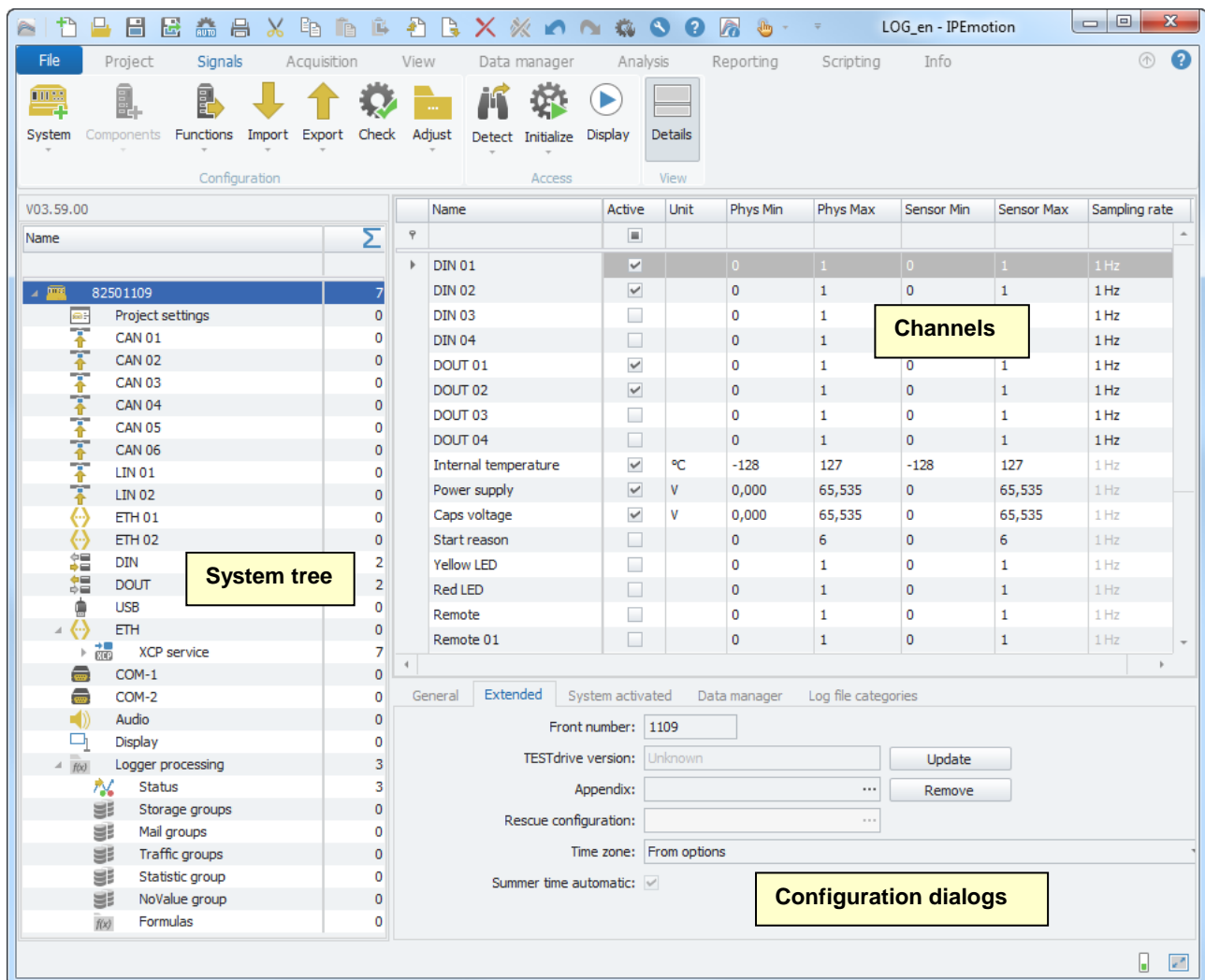

### 5.1.7 Info

The chapter offers a basic overview of the IPEmotion software. In addition, it shows useful advices and tips and tricks on how to use IPEmotion.

The view Info is divided into the following menu points:

- ▶ Welcome
- ▶ Release Notes (only in English)
- ▶ Red thread
- ▶ Tips and tricks
- ▶ Keyboard handling
- ▶ Documentations
- ▶ Contact and support

## 5.2 Logger settings

### General

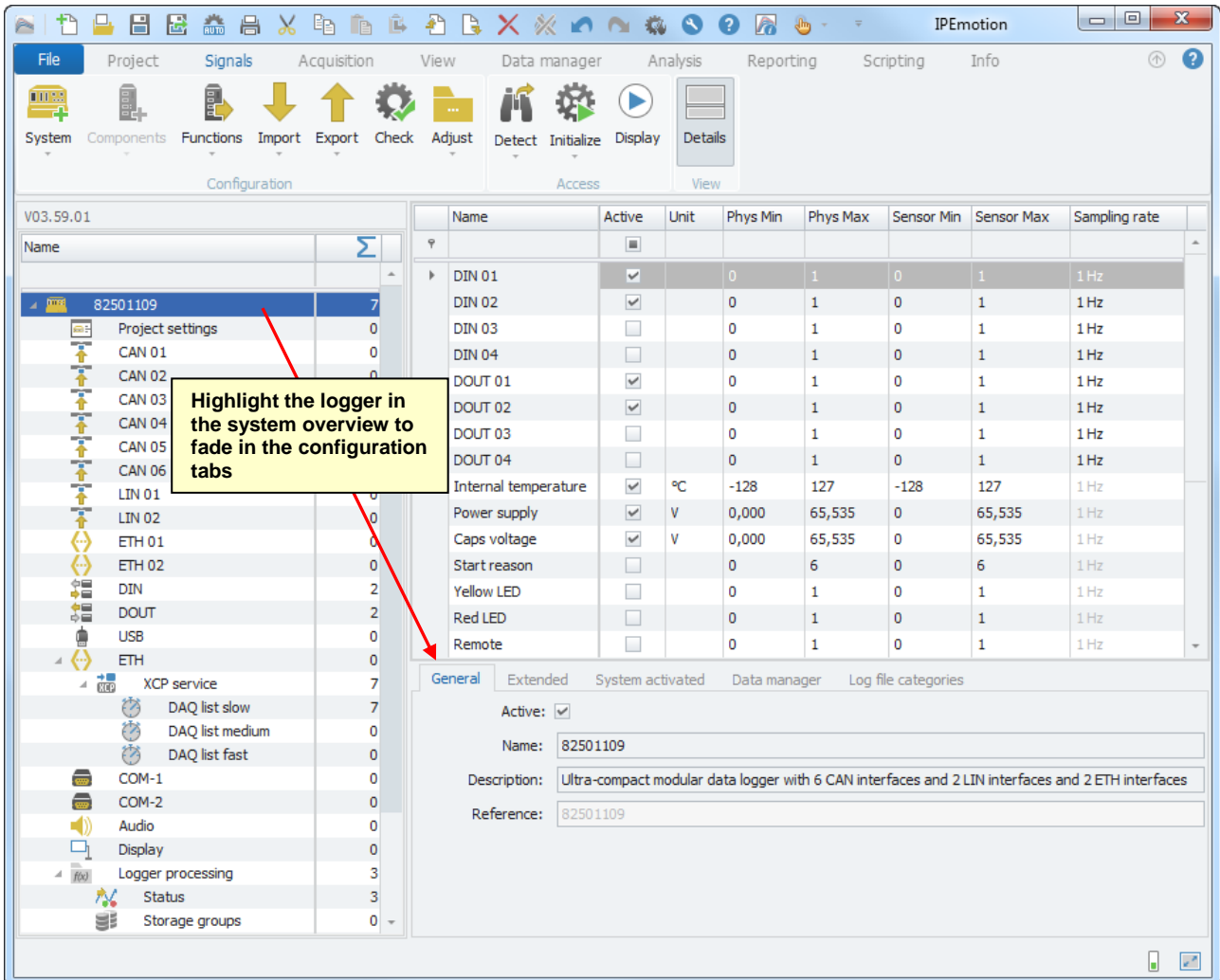

### Extended

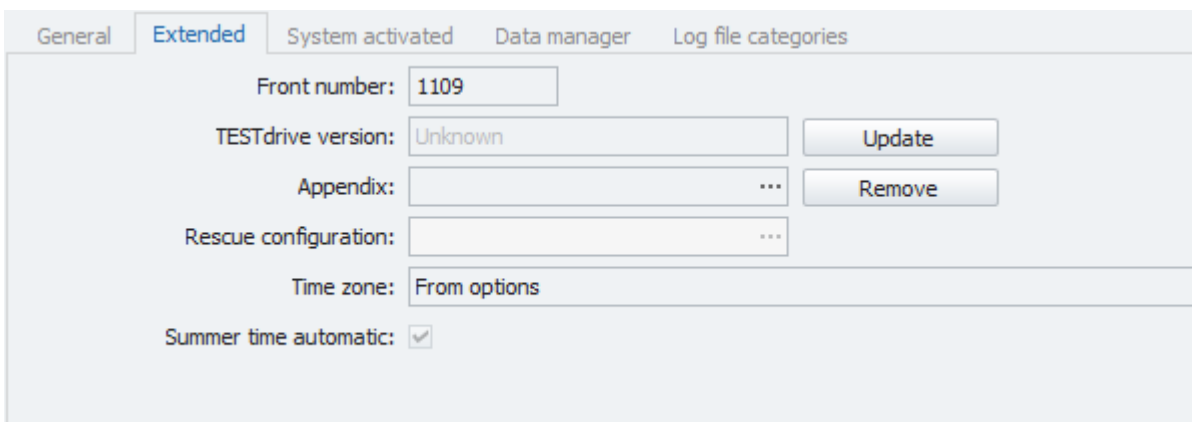

- Front number:** The last four digits of the logger serial number.
- TESTdrive version:** Version of the TESTdrive application running on the logger. With a hardware detection through a LAN/WLAN connection, the current version is indicated. A mouse click to **Update** will upload the latest version.
- Appendix:** Transfer a user specific file to the logger.
- Rescue configuration:** Store rescue configuration on the logger (fall back)
- Time zone:** Applying the PlugIn settings defined under **Options > PlugIns > PlugIn-specific settings > Time zone**
- Summer time automatic:** Automatic switch-over winter time <> summer time

### System activated

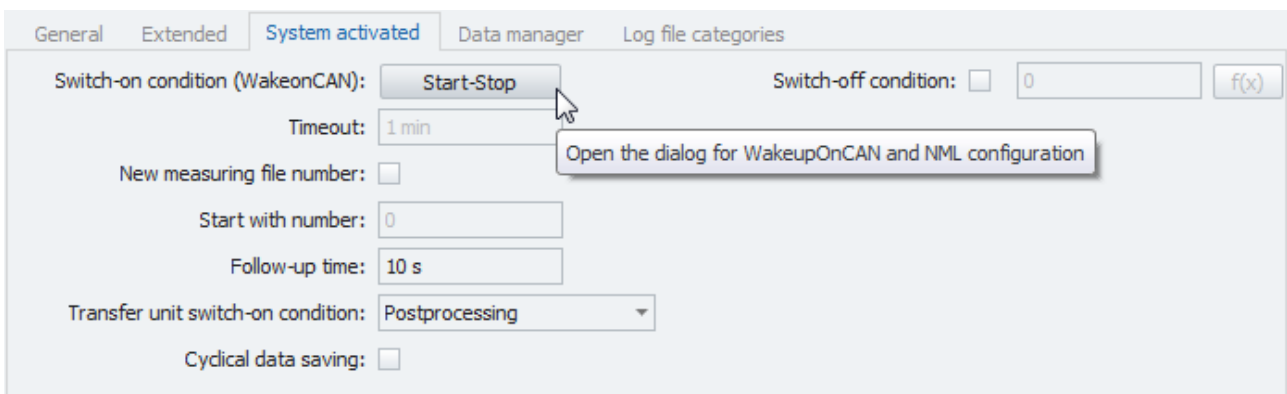

- Switch-on condition (WakeonCAN):** Selecting the CAN bus(es) to be used for boot up the logger by the WakeonCAN feature.
- Timeout:** The logger waits this period for the remote signal resp. bus activity.
- Switch-off condition:** User defined condition (trigger, formula) to be used to switch-off the logger. In case a remote signal (REM = ignition line 15) is still high, the logger will shut down and power up again.
- New measuring file number:** Consecutively numbering of measurement data files beginning with the predefined start number.
- Start with number:** Start number for the consecutive measurement file numbering
- Follow-up time:** When the switch-off signal has been identified, the logger waits this period (and keeps on operating) before shut down.
- Transfer unit switch-on condition:** Switch on the WiFi client respective the modem for wireless data transfer by the logger.
- Cyclical data saving:** Acquired data is continuously stored to the measurement data file (not only by stopping the measurement).

## Data manager

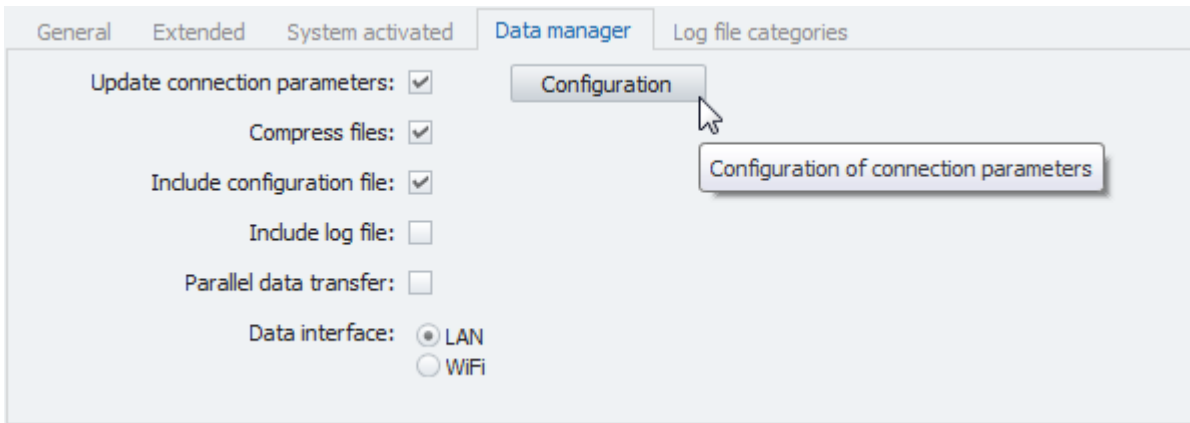

**Update connection parameters:**

Enables the access to connection parameters settings by use of the **Configuration** button.

**Compress files:**

Activated the compressing of measurement data files

**Include configuration file:**

Includes the DAQ configuration (**CFG\_XXX.isf**) in the measurement data zip file **XXX\_MEA\_XXX.zip**.

**Include log file:**

Includes the DAQ log file (**MEA\_XXX.log**) in the measurement data zip file **XXX\_MEA\_XXX.zip**.

**Parallel data transfer:**

Enables data transfer simultaneous to a running data acquisition

**Data interface:**

Selection of the communication interface (LAN, WLAN)

## Log file categories

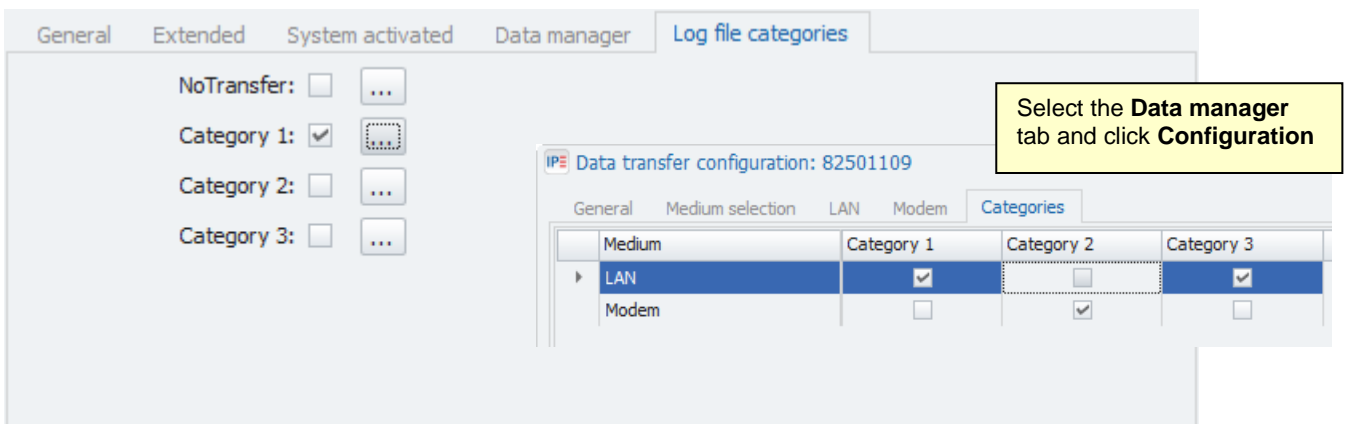

**NoTransfer:**

Exclude selected data from transfer.

**Category 1:**

Assign storage groups, log file, ... to the data transfer category #1

**Category 2**

Assign storage groups, log file, ... to the data transfer category #2.

**Category 3:**

Assign storage groups, log file, ... to the data transfer category #3



*Data groups can be linked with a single or multiple data transfer categories.*

*Although a single or multiple data transfer categories can be assigned to a data transfer medium (LAN, modem), a specific category can be assigned to a single medium only.*

## 6 Basic functions

### 6.1 Switching-on / switching-off

Description of the supported switching-on / switching-off modes

#### 6.1.1 Ignition line 15

##### Remote 1 (Ignition line 15)

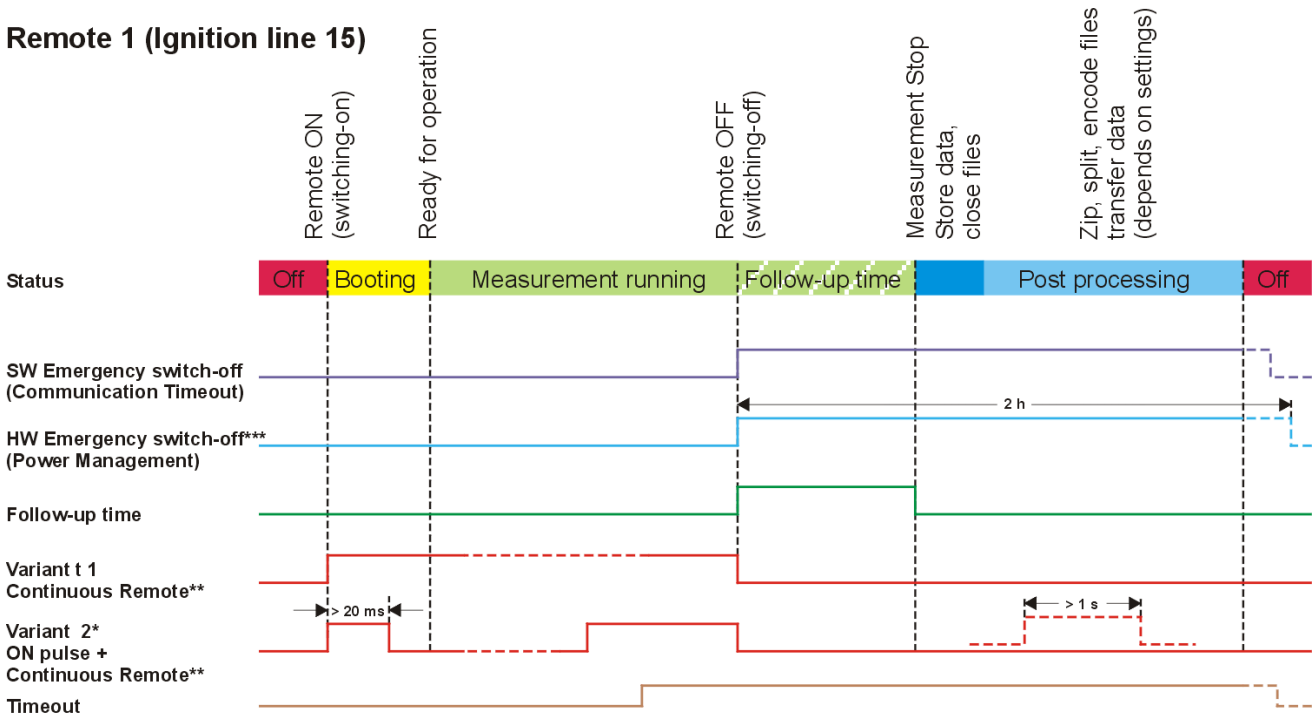

\*Variant 2: Switch-on condition (WakeOnCAN) enabled, continuous remote signal required before timeout expires

\*\*Conitnuous Remote: If a remote signal (duration > 1 s) is identified during post-processing, the logger will stop this task and start a new acquisition.

\*\*\*HW Emergency switch-off: The logger will be absolutely switched-off by the power management 2 h after the previous falling edge of the remote signal.

### 6.1.2 WakeOnCAN

#### WakeOnCAN, Ignition line 15

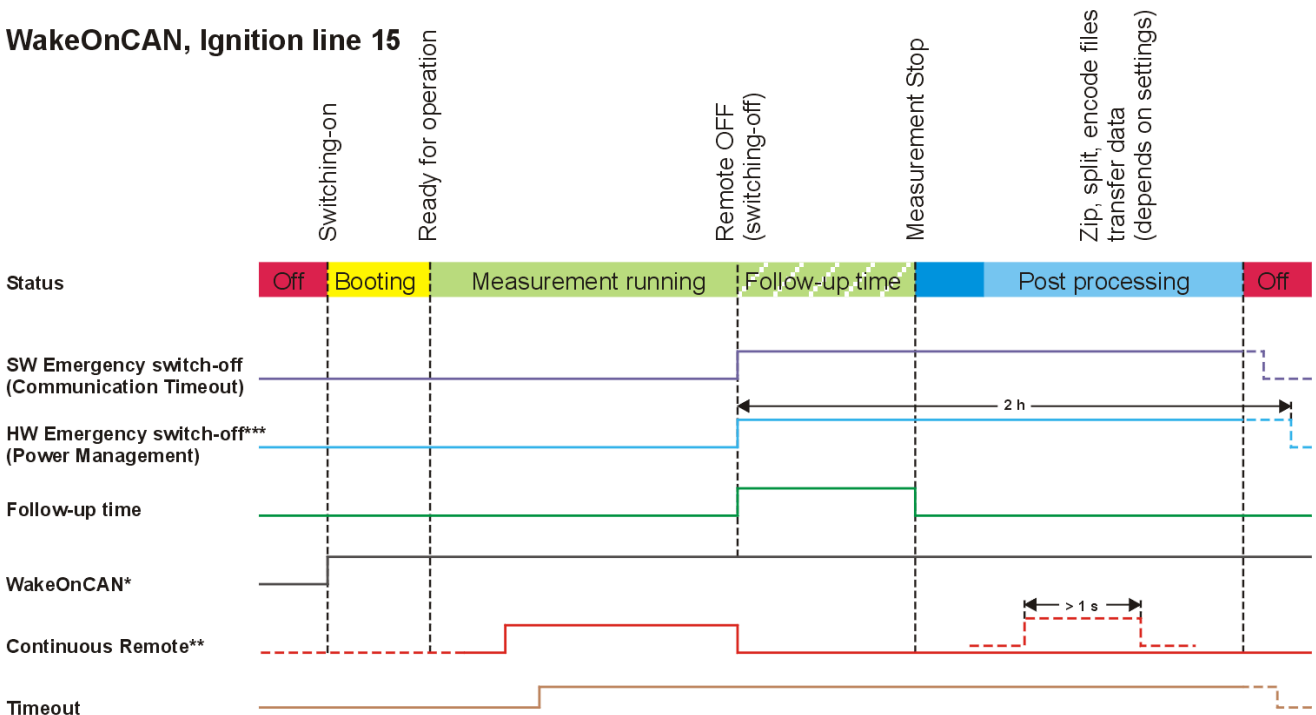

\*WakeOnCAN Ign. 15: Switch-on condition (WakeOnCAN) enabled, continuous remote signal required before timeout expires jumper Pin 3-6 and Pin 8-9 at respective CAN input to indicate bus traffic (WakeOnCAN)!

\*\*Continuous Remote: If a remote signal (duration > 1 s) is identified during post-processing, the logger will stop this task and start a new acquisition.

\*\*\*HW Emergency switch-off: The logger will be absolutely switched-off by the power management 2 h after the previous falling edge

#### WakeOnCAN without Ignition line 15

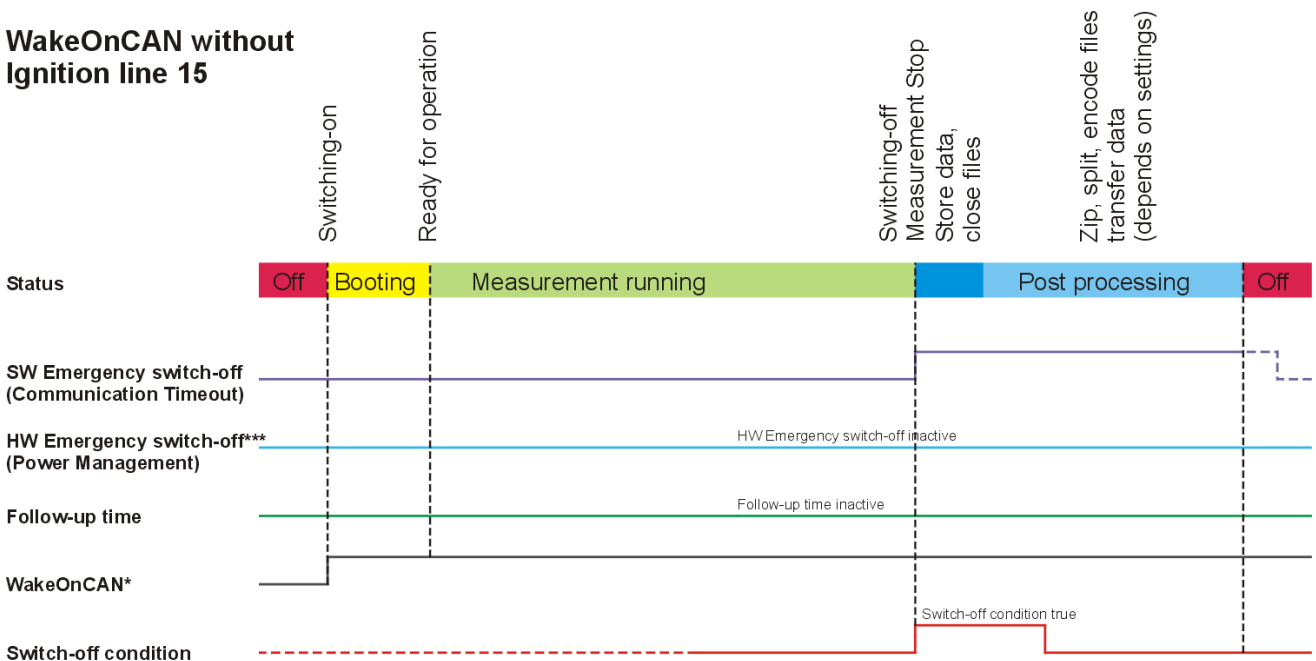

\*WakeOnCAN without Ign. 15: Switch-on condition (WakeOnCAN) enabled, Switch-off condition configured, HW Emergency switch-off and Follow-up time out of operation, Timeout inactive Jumper Pin 3-6 and Pin 8-9 at respective CAN input to indicate bus traffic (WakeOnCAN)!

### 6.1.3 WakeOnRTC (IPElog/IPElog2 only)

With TESTdrive 3.52 and higher versions, IPElog supports switching on by its internal real time clock (RTC).

Supported events:

- ▶ Once start only one single time.
- ▶ Cyclic absolute cyclic start e.g. every hour (duration --> 1h), date/time stamp defines initial start up.
- ▶ Duration start e.g. every hour without predefined start-up.



*If WakeOnCAN, WakeOnRTC or WakeOnSMS is configured with IPElog, the Ethernet status LEDs (LINK, ETH1, ETH2) will light green, even if the logger is in standby mode.*

1. Highlight the logger serial number at the left system structure.
2. Select **Start-Stop** from the tab **System activated**.
3. Activate **WakeOnRTC** from the Start/Stop configuration
4. Select a start function from the drop down field **Mode**
5. Define a **Start time** and/or **Duration** depending on the selected mode.
6. Enable the check box **Acquisition** to automatically start a data acquisition with the start-up procedure.

Name	Active	Unit	Phys Min	Phys Max	Sensor Min	Sensor Max	Sampling rate
DIN 01	<input type="checkbox"/>		0	1	0	1	1 Hz
DIN 02	<input type="checkbox"/>		0	1	0	1	1 Hz
DIN 03	<input type="checkbox"/>		0	1	0	1	1 Hz
DIN 04	<input type="checkbox"/>		0	1	0	1	1 Hz
DOUT 01	<input type="checkbox"/>		0	1	0	1	1 Hz
DOUT 02	<input type="checkbox"/>		0	1	0	1	1 Hz
DOUT 03	<input type="checkbox"/>		0	1	0	1	1 Hz
DOUT 04	<input type="checkbox"/>		0	1	0	1	1 Hz

Connector	WakeOnCAN	NML
CAN 01	<input type="checkbox"/>	<input type="checkbox"/>
CAN 02	<input type="checkbox"/>	<input type="checkbox"/>
CAN 03	<input type="checkbox"/>	<input type="checkbox"/>
CAN 04	<input type="checkbox"/>	<input type="checkbox"/>
CAN 05	<input type="checkbox"/>	<input type="checkbox"/>
CAN 06	<input type="checkbox"/>	<input type="checkbox"/>
CAN 07	<input type="checkbox"/>	<input type="checkbox"/>
CAN 08	<input type="checkbox"/>	<input type="checkbox"/>
CAN 09	<input type="checkbox"/>	<input type="checkbox"/>
CAN 10	<input type="checkbox"/>	<input type="checkbox"/>
CAN 11	<input type="checkbox"/>	<input type="checkbox"/>
CAN 12	<input type="checkbox"/>	<input type="checkbox"/>

**WakeOnRTC**

Active:

Mode: Duration

Date/Time: 02.06.2014 20:42:48

Duration: 1.00:00:00

Measure:

OK Cancel

### 6.1.4 StopStart event (Logger processing)

The StopStart function closes the measurement file and after that immediately starts a new measurement. This function is triggered by a user-defined event and starts without switching off the logger.

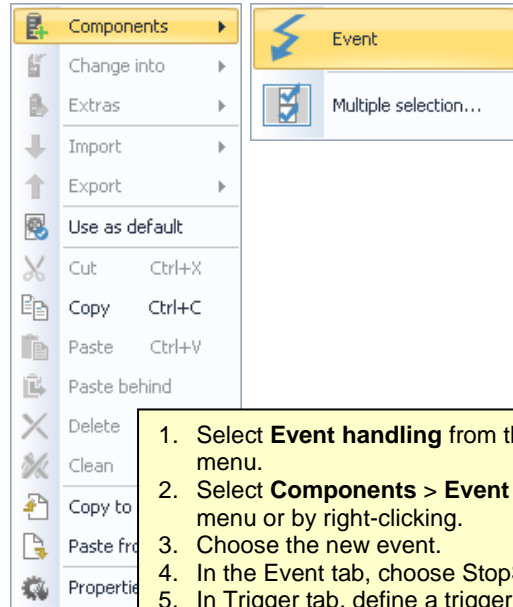
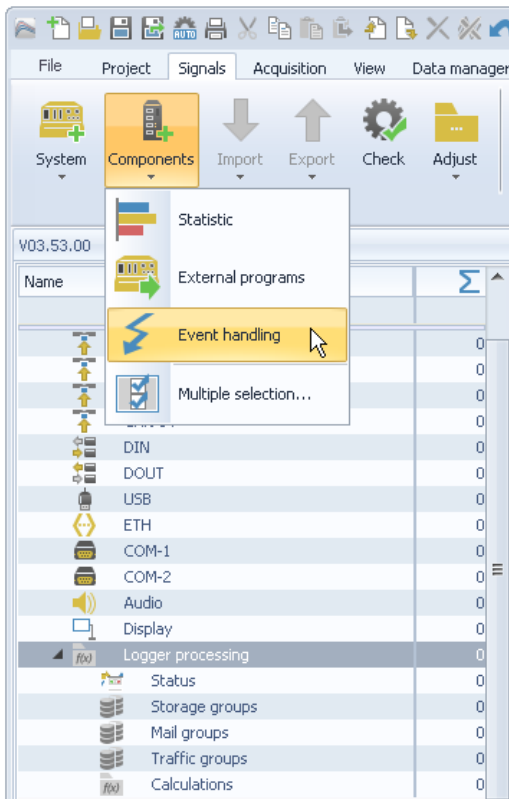

1. Select **Event handling** from the left-hand menu.
2. Select **Components > Event** from the tab menu or by right-clicking.
3. Choose the new event.
4. In the Event tab, choose **StopStart**.
5. In Trigger tab, define a triggering condition (e.g. the formula: "DIN 01" AND "DIN 02").

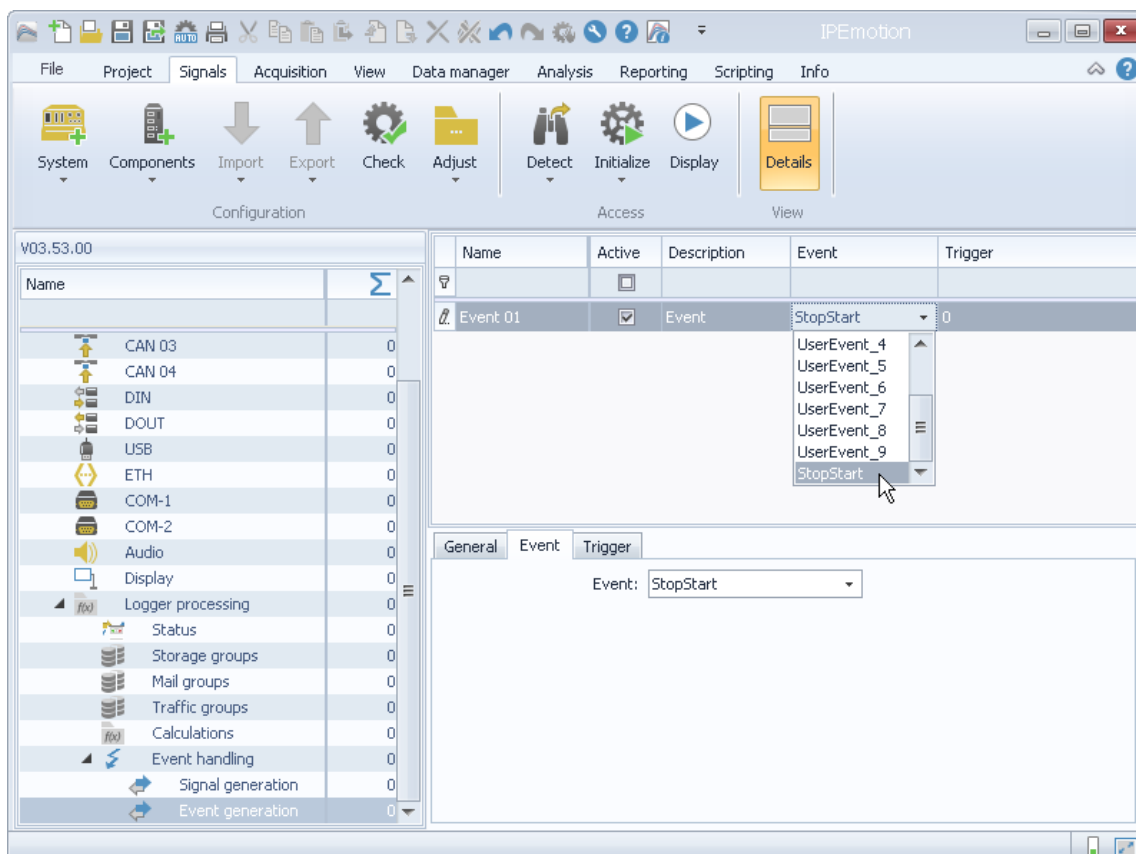



## 6.1.5 Use Cases

### WakeOnCAN with ignition on/off

#### Application

Test run with continuous measurement via signal "Ignition on / ignition off" (remote); The logger is being started using bus traffic (WakeOnCAN) in order to acquire the entire starting process. After test run, CAN activity is to be acquired using the condition „Ignition off“.

#### Requirements

- ▶ Data logger supporting WakeOnCAN feature
- ▶ Recognition communication stop on vehicle buses:
  - > IPElog or MLOG with 4CANQS cards and FPGA as of 1.08.01, TESTdrive as of 3.52.00

#### Sequence

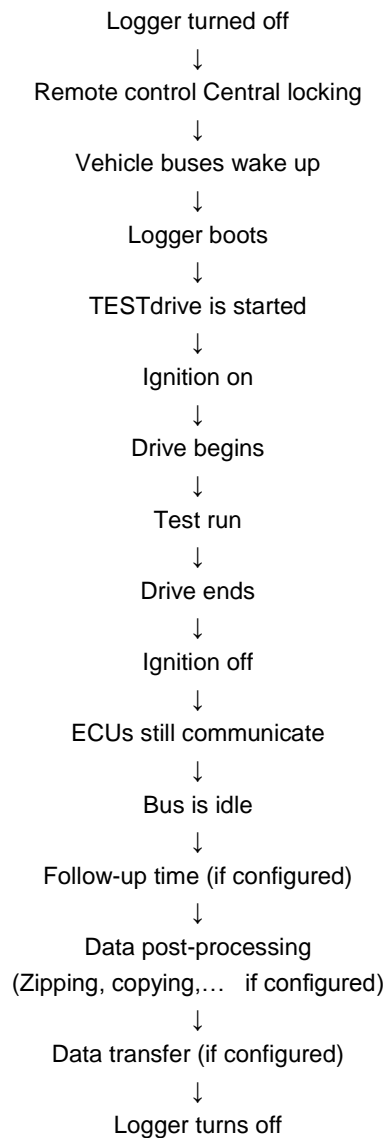

## WakeOnCAN (bus activity)

### Application

Monitoring of vehicle component on CAN, i.e. measurement as soon as/as long as the component is active, independent from ignition state.

### Requirements

- ▶ Data logger supporting WakeOnCAN feature
- ▶ Recognition communication stop on vehicle buses:
  - > IPElog or MLOG with 4CANQS cards and FPGA as of 1.08.01, TESTdrive as of 3.52.00
- ▶ Alternatively for other logger types / firmware versions:
  - > Use of switch-off condition or WakeOnCAN timeout

### Sequence

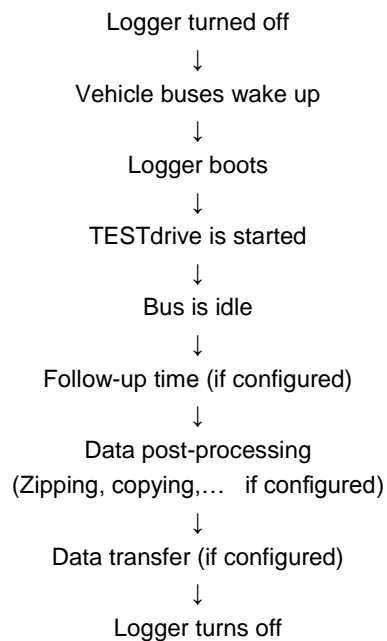

## WakeOnRTC

### Application

Independent from ignition state and bus traffic, the logger should start at 04:00 am every night, acquire data via connected analog modules for 2 minutes and switch back to idle state.

### Requirements

- ▶ IPElog with TESTdrive as of 3.52.00

### Sequence

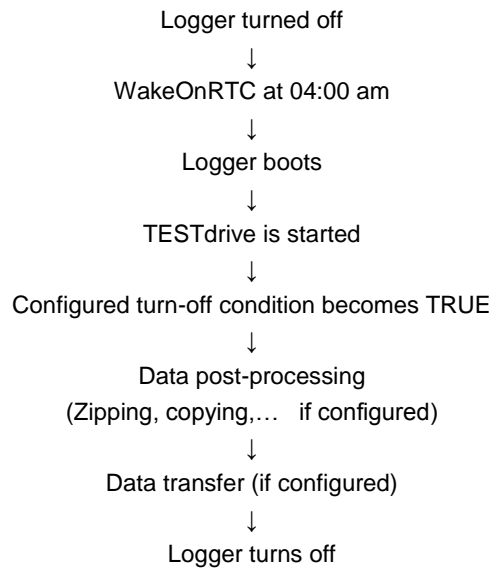

## 6.2 Triggering

The logger acquisition program offers 4 trigger conditions for every storage group to control the data acquisition. The trigger conditions can be deduced from acquired signals, as well as, from calculated channels. All data is written into the memory (RAM). If a storage condition is met, the data is asynchronously written from the cache into the open measuring file on the flash card.

### 6.2.1 Start-trigger

Start of data storage if trigger condition (impulse) is met. Stop of storage with (correct) logger shut-down (Power down). A defined follow-up time extends the data acquisition for x seconds.

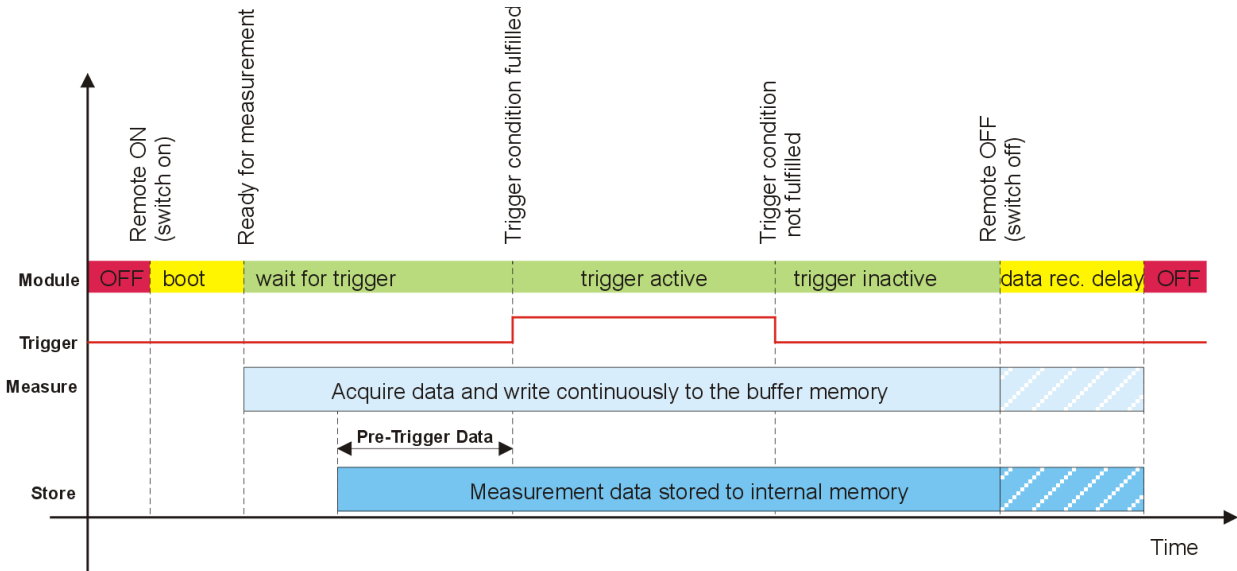

### 6.2.2 Stop-trigger

Begin of data storage with logger switch-on (Power up). Stop of data storage if trigger condition (impulse) is met. A defined follow-up time extends the data acquisition for x seconds. If no trigger event is set, data is recorded until "Remote OFF" or end of the follow-up time.

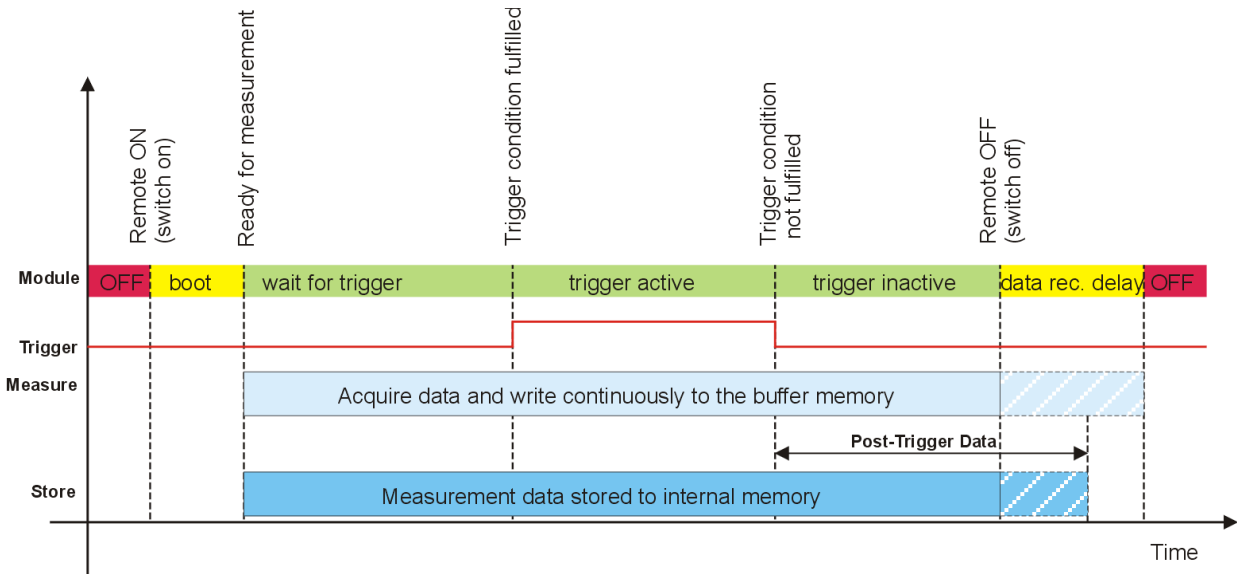

We recommend to use the function `VALID(x ; y)` in order to avoid irregular NoValues which may influence a correct triggering.

Example:

Start-trigger: `VALID(„Channel01“ > 15; 0)`

Storage as soon as `Channel01 > 15`

Stop-trigger: `VALID(„Channel01“ > 15; 1)`

Storage as long as `Channel01 > 15`

### 6.2.3 Start- and Stop-trigger

Begin of data storage if start-trigger condition (impulse) is met. Stop of data storage if stop-trigger condition (impulse) is met.

A defined follow-up time extends the data acquisition for x seconds. If no stop-trigger event is set, data is recorded until "Remote OFF" or end of the follow-up time.

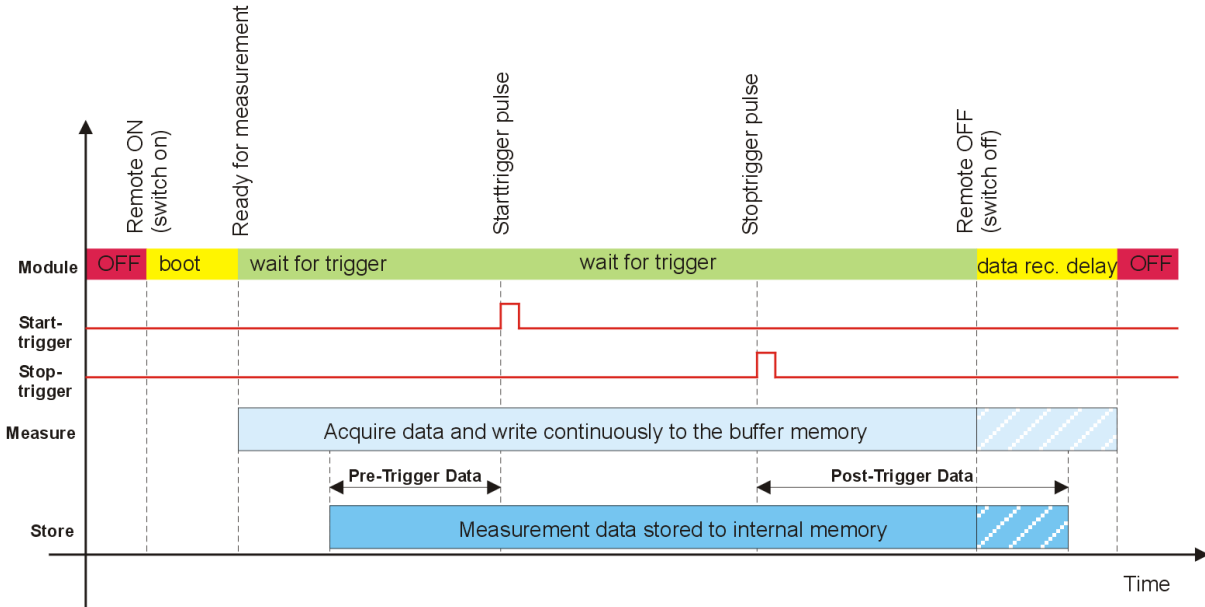

### 6.2.4 Stop is inverted start

Data storage for the time of meeting trigger condition (status).

A defined follow-up time extends the data acquisition for x seconds. If trigger status does not change after successful trigger condition, data is recorded until "Remote OFF" or end of the follow-up time.

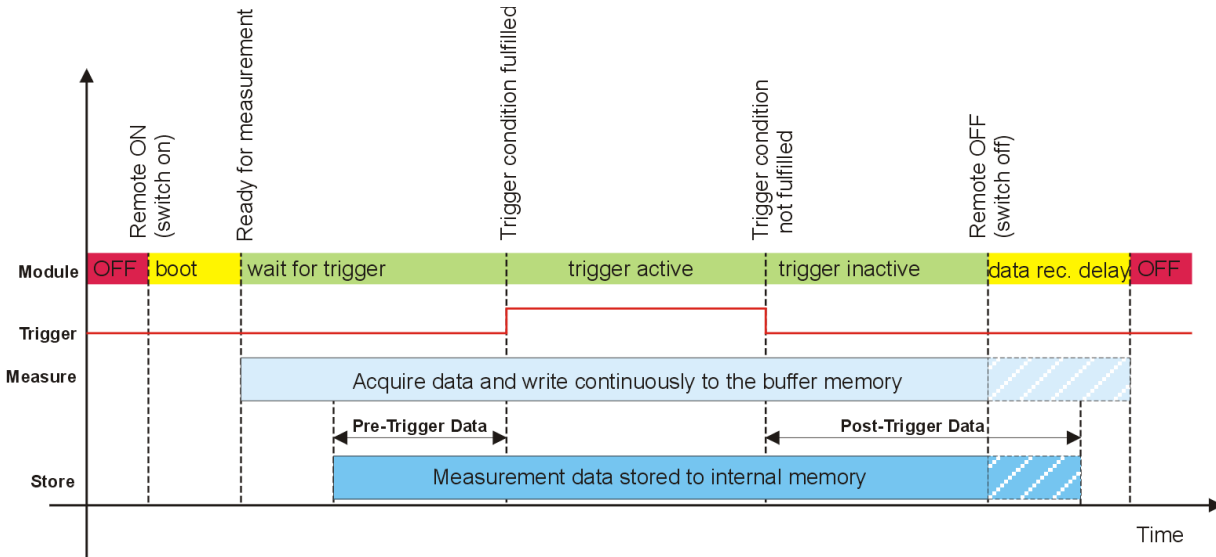

The **Follow-up time** may not be mistaken for the **Post-processing time**. Both settings must be coordinated. The maximum post-processing time is set with **Logger > Settings > Data transfer timeout**. This setting limits the switch-on duration after successful "Remote OFF" signal. The logger is regularly shut down after this time even if the data post-processing (zipping, splitting, sending) is not yet completed. The post-processing value must be at least 5 min greater than the currently set follow-up time!

## 6.2.5 Save trigger channel

If **Save trigger channel** is activated, trigger status and some additional information are stored in an implicit channel (Word data format) in every storage group.

Bit coded information in trigger status channel		
Bit No.	Description	Description (if bit value = 1)
0	Pre-Trigger	Pre-trigger time running
1	Between start and stop	Trigger signal status This bit is set during the whole acquisition in <b>Continuous acquisition</b> mode.
2	Post-trigger	Post-trigger time running
3	Trigger Event	This bit is set for the time of one signal at every Low > High of the trigger signal. It is set once at acquisition start in <b>Continuous acquisition</b> mode.
4	Maneuver	Maneuver recording running (No NoValues available anymore)
5	Res	Currently not used!
6	Res	Currently not used!
7	Res	Currently not used!
8	Res	Currently not used!
9	Res	Currently not used!
10	Res	Currently not used!
11	Res	Currently not used!
12	WakeOnCAN	WakeOnCAN ist active
13	Power Bad	The logger is disconnected from the power supply.
14	Power Good	Buffer capacitors loaded
15	KL. 15	Debounced remote signall (terminal 15)

### 6.3 Data groups (storage, e-mail, traffic, statistic, novalue)

TESTdrive 3,55 supports 5 different types of data groups:

- ▶ Storage groups                      time related data storage on the logger
- ▶ Mail groups                            send data snap shot at trigger event per e-mail
- ▶ Traffic groups                        event related (time stamp) data storage on the logger (trace data), license required
- ▶ Statistic group                        STG file (Statistic Group) containing min, max, mean values of the respective signals created at the end of each measurement
- ▶ NoValue group                        NoValue monitoring of defined signals

TESTdrive supports various data groups to merge signals (direct signals, as well as, calculated channels) for further data processing. Storage groups can have an own storage rates – independent from the signal rate. This storage rate can be valid for all signals in the group, i.e. the signal is detected with the set sampling rate and recorded with the storage rate or the individual signal sample rate is used for storage.

The maximum storage rate of a group is defined by the signal with the highest sampling rate. The frequency for online calculations corresponds to the highest sampling rate in the calculation.

Each data group has its own trigger condition (see [6.2 Triggering](#)) which can be individually defined by the user. This offers the possibility to process (storage, sending) selected signals dependent on specific events occurring, which may reduces the amount stored data and provides an easier offline data analysis.

Overview				
Data group	Settings	Trigger	Category	Remark
Storage groups	storage rates, time stamp and trigger channel, NoValues, enable external storage medium , storage group name = mea prefix	different trigger modes available, formula to define trigger condition	Yes	time related cyclic data acquisition
Traffic groups	enable external storage medium , storage group name = mea prefix	different trigger modes available, formula to define trigger condition	Yes	time stamp related bus trace acquisition
Mail groups	recipients, subject line	formula to define trigger condition	No	signal snap shot at trigger event as status information
Statistic group	none	none	Yes	min/max /average values at measurement stop
Novalue group	none	formula to define trigger condition	No	log file reporting

#### Categories (Data transfer category)

Data groups that create measurement data files can be assigned to data transfer categories 1, 2, 3 or they can be excluded from data transfer. Each category can be linked with a single data transfer medium, whereas all three categories can be assigned to the same data transfer medium.

Refer to [7.10 Data transfer & communication](#)

### 6.3.1 Storage groups

1. Select **Signals** navigation tab.
2. Select **Storage groups**.
3. Select **Add component > Storage group** from the tab menu or the context menu (right mouse button).
4. Enter a name and a description in the **General** tab.
5. Activate the storage group
6. Select **Add component > Channels** from the tab menu or the context menu (right mouse button).
7. Select the signals and confirm with **OK**.
8. Define additional parameters with **Settings** und **Triggering**.

#### Storage group

General	Settings	Triggering
Storage rate: From channel		
Time stamp channel:	<input type="checkbox"/>	
NoValues:	<input checked="" type="checkbox"/>	
Save trigger channel:	<input type="checkbox"/>	
Prefix:	<input type="checkbox"/>	
External storage:	<input type="checkbox"/>	

#### Ring buffer group

General	Settings	Triggering
Storage rate: From channel		
Time stamp channel:	<input checked="" type="checkbox"/>	
NoValues:	<input type="checkbox"/>	
Save trigger channel:	<input type="checkbox"/>	
Prefix:	<input type="checkbox"/>	
Ring buffer		
Ring buffer size: 1 s		

**Storage rate** Selection of a fixed storage rate or a channel related storage rate (From channel). Using the setting **From channel** means, the channel with the highest sample rate within the storage group will determine the storage rate.

**Time stamp channel** The measuring data contain the absolute time channel (logger time).

**NoValue** The NoValue between the trigger events, which is defined in the respective channel, is added with **Format**.



- Save trigger channel** The trigger status channel is added to the storage group and recorded. This channel contains additional information, which is saved with the single bits in the data set.
- Prefix** The storage group name is used for the measurement data file name.
- External storage** Data storage on external USB storage medium. Refer to [6.5 USB medium for external storage](#) for detailed information.
- Ring buffer size** Defines the size of the ring buffer for measuring. If the max ring buffer size is reached, the memory is overwritten beginning with the oldest data.



Use the ring buffer group to record data that are only needed in case an unknown event happens, e.g. in the event of a fault. The ring buffer group contains all selected signals of a defined period before end of measurement.

Choosing ring buffer size, consider the number of channels and defined data rates

### 6.3.2 Mail groups

1. Select **Signals** navigation tab.
2. Select **Mail groups**.
3. Select **Add component > Mail group** from the tab menu or the context menu (right mouse button).
4. Enter a name and a description in the **General** tab.
5. Activate the mail group
6. Select **Add component > Channels** from the tab menu or the context menu (right mouse button).
7. Select the signals and confirm with **OK**.
8. Define one or more recipients using **Settings** and define the start condition under **Trigger**.

The screenshot shows the IPeMotion software interface. On the left, a tree view under 'Mail groups' shows 'Mail group 02' selected. A red arrow points from this selection to the 'Settings' tab of the configuration panel on the right. The 'Settings' tab shows the following configuration:

- Active:
- Name: Mail group 02
- Description: Mail group on the data logger
- Reference: Mail group 02/80002367

Below the tree view, a table lists the channels for Mail group 02:

Channel	Index	Active	Unit	Sampling rate
57801407_3	1	<input checked="" type="checkbox"/>	°C	2 Hz
57801407_4	2	<input checked="" type="checkbox"/>	°C	2 Hz
CPU load	3	<input checked="" type="checkbox"/>	%	1 Hz
57801407_1	4	<input checked="" type="checkbox"/>	°C	2 Hz
58601209_1	5	<input checked="" type="checkbox"/>	Hz	500 Hz
58601209_2	6	<input checked="" type="checkbox"/>	Hz	500 Hz

The screenshot shows the 'Trigger' tab of the configuration panel. It contains the following settings:

- Subject: Exceeding temperature limit!
- Formula: "57801407\_3" > 90

An 'f(x)' button is visible at the bottom right of the formula field.



Enter the logger settings **Data manager > Configuration > E-mail** to set the e-mail recipient and the mail server.



Creating mail groups is independent from a status e-mail. The e-mail from the mail group configuration is send, as soon as the trigger event occurs. In case of activated e-mail delivery using the data transfer configuration, a status e-mail is send at the end of each measurement.

### 6.3.3 Statistic group

Channel	Index	Active	Unit	Sampling rate
57800547_1	1	<input checked="" type="checkbox"/>	°C	10 Hz
57800547_2	2	<input checked="" type="checkbox"/>		1 Hz
CPU load	3	<input checked="" type="checkbox"/>	%	1 Hz

Statistic groups contain min, max and mean values of the respective signals stored in the STG file, which is created at the end of each measurement.

Please also refer to

#### 11.5.1 Data types > Min-Max list (STG file)

1. Activate the **Signals** tab.
2. Highlight **Statistic group**.
3. Select **Components > Statistic group** from the tab menu or the context menu (right mouse button).
4. Enter a name and a description in the **General** tab.
5. Activate the **Statistic group**.
6. Select **Add component > Channels** from the tab menu or the context menu (right mouse button).
7. Select the signals and confirm with **OK**.
8. Define a data transfer category to be used under **Categories**.

You can now add your statistic information easily into a new created statistic group. You can create several statistic groups which can be transferred through different means.

Using the “Components” button, you can open the channel selection window to select the channel you would like to include in the Min-Max statistic calculation.

### 6.3.4 NoValue group

The screenshot displays the IPeMotion software interface. The left pane shows a tree view of the project structure. The 'NoValue group 01' is selected, and a red arrow points to it. The right pane shows a table of channels and a configuration panel for the selected group.

Channel	Index	Active	Unit	Sampling rate
57800547_1	1	<input checked="" type="checkbox"/>	°C	10 Hz
57800547_2	2	<input checked="" type="checkbox"/>	°C	10 Hz
57801328_1	3	<input checked="" type="checkbox"/>	°C	10 Hz
57801328_2	4	<input checked="" type="checkbox"/>	°C	10 Hz
CPU load	5	<input checked="" type="checkbox"/>	%	1 Hz

The configuration panel for the 'NoValue group 01' shows the following settings:

- Active:
- Name: NoValue group 01
- Description: NoValue group on the data logger
- Reference: NoValue group 01/80001620

A NoValue group serves for monitoring invalid values occurring during data acquisition. Each NoValue event (means that a sequence of valid signal values is interrupted by one or more invalid values) creates a log file entry. You can use specific triggers to activate the NoValue group (for example: "CPU load" > 30 %).

Refer to **7.1.3 NoValue and timeout settings**

### 6.3.5 Traffic groups

Time stamp related storage of CAN bus and/or LIN bus messages.

Refer to **8.2.3 Traffic acquisition**

For explanations on cyclic and event-controlled data acquisition refer to **7.8 Event controlled measurement**

### 6.3.6 Trigger settings

- Mode** Select the trigger mode from Continuous acquisition (no trigger), Start-trigger, Stop-trigger, Start- and Stop-trigger, Stop as inverted start (see [Triggering](#))
- Pre-trigger duration** Data recorded before the trigger event
- Post-trigger duration** Data recorded after the trigger event
- Start-trigger** Value, which starts the data storage of the respective group.
- Stop-trigger** Value, which stops the data storage of the respective group.
- Scaling** Triggering the physical value or the raw value of the numerical value calculated with the formula.



*Define the triggering conditions as formula from the system signals and calculated signals. You can optimize your data recording with a clever configuration of storage groups and triggering conditions to record signals at a high storage rate only if required. This method reduces the data volume, saves memory, and facilitates the final analysis!*

## 6.4 Status channels

### 6.4.1 Logger, Logger processing

The screenshot shows the IPEmotion software interface with the 'Signals' menu selected. The left sidebar shows a tree view of components, with 'Logger processing' expanded. The main window displays a table of status channels and a configuration panel for the selected 'CPU load' channel.

Name	Active	Unit	Phys Min	Phys Max	Sensor Min
Remote 02	<input type="checkbox"/>		0	1	0
Wake on CAN	<input type="checkbox"/>		0	1	0
CPU load	<input checked="" type="checkbox"/>	%	0	100	0
Uptime	<input type="checkbox"/>	s	0,000	4294967,295	0
Storage space	<input type="checkbox"/>	MB	0	4294967295	0
Time left	<input type="checkbox"/>	s	0	4294967295	0
Limit violation	<input type="checkbox"/>		0	1	0
Measurement number	<input type="checkbox"/>		0	9999	0

**Configuration Panel for CPU load:**

- Active:
- Name: CPU load
- Description: Define the percental CPU load of TESTdrive.
- Reference: CPU load////80002367
- Sampling rate: 1 Hz

### 6.4.2 Video recording

The screenshot shows the IPEmotion software interface with the 'Signals' menu selected. The left sidebar shows a tree view of components, with 'Video recording' expanded. The main window displays a table of status channels and a configuration panel for the selected 'Video file size' channel.

Name	Active	Unit	Phys Min	Phys Max	Sensor Min	Sensor Max	Sampling rate
Video file size	<input checked="" type="checkbox"/>	MB	0,0000000	4096,0000000	0	4096	1 Hz

**Configuration Panel for Video file size:**

- Active:
- Name: Video file size
- Description: Video file size of USB video
- Reference: Video file size///Video recording/80002367
- Sampling rate: 1 Hz

## 6.5 USB medium for external storage

TESTdrive supports USB sticks and USB hard disks for storage on external drives in two different modes:

- ▶ External USB medium as alternative storage (solely saving on internal drive OR external drive).
- ▶ External USB medium as supplemental storage (depending on data type settings saving on internal drive OR external drive).

### 6.5.1 External medium is the data drive of the logger

The USB medium is the data drive of the logger. Data is stored on this storage type exclusively. TESTdrive creates the standard folder structure on the USB drive. Depending on the current settings, data post processing and shutdown will be executed in different ways.



***Because of data loss, do not disconnect the USB medium during measurement!***

#### Behaviour with FullPostprocessing

Since TESTdrive V03.23.00 this is the default setting when using an USB data drive.

##### Requirement

The non-bootable USB device has to be insert before starting the logger (refer to **6.5.2 External USB medium as supplemental data drive** for preparing the device). There should be no TESTdriveCmd.xml available on the USB medium.

##### Utilization

During boot-up, the logger identifies the USB medium and reports "USB drive is data drive". Measurement data is stored to the subdirectory named with the logger's serial number on this storage medium. The FullPostprocessing procedure starts with the RemoteOff condition.

#### Behaviour without FullPostprocessing

This is the former procedure used for USB data storage until TESTdrive V03.22.01.

##### Requirement

The non-bootable USB device has to be insert before starting the logger (refer to **6.5.2 External USB medium as supplemental data drive** for preparing the device). There should be no TESTdriveCmd.xml available on the USB medium. With TESTdrive version V03.23.00 and subsequent releases the following command line has to be added to the dev\_ctrl.xml in order to activate the usage:

```
<fastUsbDatatDriveChange>1</fastUsbDatatDriveChange>
```

##### Utilization

During boot-up, the logger identifies the USB medium and reports "USB drive is data drive". Measurement data is stored to the subdirectory named with the logger's serial number on this storage medium. The RemoteOff condition starts the following jobs:

- ▶ Checkdisk
- ▶ Preparing the directory structure on the USB medium
- ▶ Deleting temporary files and directories
- ▶ Power down



*Independent from any data transfer settings, measurement and configuration data will not be transferred for data drives without postprocessing.*

## 6.5.2 External USB medium as supplemental data drive

The USB storage medium is used in addition to the internal data drive of the logger. Depending on the current settings, data is stored either to the internal drive or to the external medium. TESTdrive will create the directory structure in any case.

The following data types are supported on the external USB medium:

- ▶ as of **TESTdrive V03.52** storage and traffic groups
- ▶ as of **TESTdrive V03.58** storage, traffic groups and USB video records

### Requirement



*The non-bootable USB storage medium has to be formatted correctly!*

The Windows console software **diskpart** can be used to prepare a non-bootable USB drive for external storage.



*Please take care that you select the correct drive of your PC when using diskpart!*

*Formatting an incorrect (internal) PC drive may cause serious problems or damage the computer!*

### DiskPart commands and meaning

- DISKPART> list disk** → Listing available drives
- DISKPART> select disk 8** → Selecting the respectiv drive (here disk 8)
- DISKPART> clean** → Cleaning the selected drive
- DISKPART> create partition primary** → Creating primary partition using the full drive size
- DISKPART> format fs=exfat label=ExtStorage quick** → Fast formatting with the exFAT format and USB stick name  
ExtStorage (label is an optional parameter)
- DISKPART> exit** → Closing DiskPart

### Sample screenshot showing list commands

```
Microsoft Windows [Version 6.1.7601]
Copyright (c) 2009 Microsoft Corporation. Alle Rechte vorbehalten.

F:\>diskpart

Microsoft DiskPart-Version 6.1.7601
Copyright (C) 1999-2008 Microsoft Corporation.
Auf Computer: IT02-0277

DISKPART> list disk

  Datenträger ###  Status              Größe             Frei              Dyn              GPT
-----
  Datenträger 0    Online              465 GB            0 B              *
  Datenträger 1    Online              698 GB            0 B
  Datenträger 2    Online              167 GB            0 B
  Datenträger 3    Online              465 GB            0 B
  Datenträger 4    Kein Medium         0 B               0 B
  Datenträger 5    Kein Medium         0 B               0 B
  Datenträger 6    Kein Medium         0 B               0 B
  Datenträger 7    Kein Medium         0 B               0 B
  Datenträger 8    Online              7640 MB           0 B
```



```

DISKPART> select disk 8
Datenträger 8 ist jetzt der gewählte Datenträger.
DISKPART> list partition

   Partition ###   Typ                Größe      Offset
-----
   Partition 1     Primär            7636 MB    4032 KB

DISKPART> clean
Der Datenträger wurde bereinigt.
DISKPART> list partition
Auf diesem Datenträger sind keine Partitionen, die angezeigt werden können,
anden.
DISKPART> create partition primary
Die angegebene Partition wurde erfolgreich erstellt.
DISKPART> list partition

   Partition ###   Typ                Größe      Offset
-----
* Partition 1     Primär            7639 MB    1024 KB

DISKPART> format fs=exfat label=ExtStorage quick
   100 Prozent bearbeitet
DiskPart hat das Volume erfolgreich formatiert.
DISKPART> exit
Datenträgerpartitionierung wird beendet...
F:\>_

```



Upon completion of this preparation, the USB medium is ready for use with IPElog and M-LOG V3, but not with M-LOG, as the BIOS of the logger types are different!

For usage with M-LOG, the MBR (Master Boot Record) of the USB medium has to be deleted.



**Once the MBR of the medium has been deleted, it can be no longer used with IPElog or M-LOG V3!**

**We recommend to prepare separate USB storage devices for the respective logger types.**

**Deleting the bootloader requires a determination of logical and physical drive!**

The tool **Hex Workshop** can be used for deleting the bootloader, as it supports access to the physical part of the drive.

The tool is available for download from:

<http://www.hexworkshop.com/>

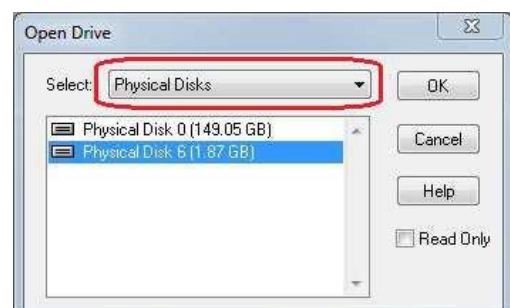

The MBR (Master Boot Record) is the physical drive area. The bytes assigned to address range 0x000 to 0x01B7 (Bootloader) have to be deleted, this means set to 0.

	0	1	2	3	4	5	6	7	8	9	A	B	C	D	E	F	10	11	12	13	14	15	16
00000000	00	00	00	00	00	00	00	00	00	00	00	00	00	00	00	00	00	00	00	00	00	00	00
00000017	00	00	00	00	00	00	00	00	00	00	00	00	00	00	00	00	00	00	00	00	00	00	00
0000002E	00	00	00	00	00	00	00	00	00	00	00	00	00	00	00	00	00	00	00	00	00	00	00
00000045	00	00	00	00	00	00	00	00	00	00	00	00	00	00	00	00	00	00	00	00	00	00	00
0000005C	00	00	00	00	00	00	00	00	00	00	00	00	00	00	00	00	00	00	00	00	00	00	00
00000073	00	00	00	00	00	00	00	00	00	00	00	00	00	00	00	00	00	00	00	00	00	00	00
0000008A	00	00	00	00	00	00	00	00	00	00	00	00	00	00	00	00	00	00	00	00	00	00	00
000000A1	00	00	00	00	00	00	00	00	00	00	00	00	00	00	00	00	00	00	00	00	00	00	00
000000B8	00	00	00	00	00	00	00	00	00	00	00	00	00	00	00	00	00	00	00	00	00	00	00
000000CF	00	00	00	00	00	00	00	00	00	00	00	00	00	00	00	00	00	00	00	00	00	00	00
000000E6	00	00	00	00	00	00	00	00	00	00	00	00	00	00	00	00	00	00	00	00	00	00	00
000000FD	00	00	00	00	00	00	00	00	00	00	00	00	00	00	00	00	00	00	00	00	00	00	00
00000114	00	00	00	00	00	00	00	00	00	00	00	00	00	00	00	00	00	00	00	00	00	00	00
0000012B	00	00	00	00	00	00	00	00	00	00	00	00	00	00	00	00	00	00	00	00	00	00	00
00000142	00	00	00	00	00	00	00	00	00	00	00	00	00	00	00	00	00	00	00	00	00	00	00
00000159	00	00	00	00	00	00	00	00	00	00	00	00	00	00	00	00	00	00	00	00	00	00	00
00000170	00	00	00	00	00	00	00	00	00	00	00	00	00	00	00	00	00	00	00	00	00	00	00
00000187	00	00	00	00	00	00	00	00	00	00	00	00	00	00	00	00	00	00	00	00	00	00	00
0000019E	00	00	00	00	00	00	00	00	00	00	00	00	00	00	00	00	00	00	00	00	00	00	00
000001B5	00	00	00	A3	76	09	00	00	00	00	00	21	00	0B	0B	CB	CB	20	00	00	00	E0	BF
000001CC	3B	00	00	00	00	00	00	00	00	00	00	00	00	00	00	00	00	00	00	00	00	00	00
000001E3	00	00	00	00	00	00	00	00	00	00	00	00	00	00	00	00	00	00	00	00	00	00	00
000001FA	00	00	00	00	55	AA																	

The TESTdriveCmd.xml with the contents listed below has to be copied to the USB medium:

```
<TESTdriveCmd>
  <Authentication>
    <user>guest</user>
    <password>ipe_guest</password>
  </Authentication>
  <OnConnect>
    <JobList>
      <Job>
        <Name>startExternalStorage</Name>
      </Job>
    </JobList>
  </OnConnect>
  <OnDisconnect>
    <JobList>
      </JobList>
  </OnDisconnect>
</TESTdriveCmd>
```



*Using a TESTdriveCmd.xml with other commands will execute these jobs and waiting for disconnecting the USB medium.  
The storage to the external drive will not be started in this case.*

In addition to an appropriate TESTdriveCmd.xml, the correct settings for storage and/or traffic groups or USB video recording are required → Activate **External storage**.

General Settings Triggering Categories

Storage rate: From channel

Time stamp channel:

NoValues:

Save trigger channel:

Prefix:

Prefix preview: DO

**External storage:**

With USB video recordings, the total memory space available on the USB device can be limited by PlugIn specific settings.

(Options → PlugIns → IPETRONIK LOG PlugIn-specific settings → Extended → Open system setup).

IP Extended options

Video input

Maximum memory space: 1000 MB

Maximum memory space (external): 1000 MB

Maximum file length: 1000 MB

## Application

Storage on external USB device is supported for triggered measurements as well as continuous measurements (TESTdrive V03.54.00 or a newer release required).

The USB medium can be connected to the logger before boot up or when the measurement has been already started (TESTdrive ≥ V03.54.00). TESTdrive writes data directly to the external USB drive.

If the start trigger for data storage is active but no USB device available, the logger will report the respective warning:

"No USB-Stick with TESTdriveCmd. Storage group [Name] cannot be stored externally."

"No USB-Stick with TESTdriveCmd. Traffic group [Name] cannot be stored externally."

"Video([Nummer]): No USB-Stick with TESTdriveCmd. Video files cannot be stored externally."

The external storage has to be stopped before unplugging the USB medium. We recommend to end the complete measurement (not only USB storage) as the operating system could respond unforeseeable on unplugging the USB medium. If this procedure is not possible, a stop trigger has to be configured to end the data storage regularly.



*Unplugging the USB medium while external storage groups are active causes data loss!*

*Configure stop trigger conditions or end the measurement (power down) to unplug the USB medium from the logger without data loss.*

## 7 Standard functions

### 7.1 Calculations

TESTdrive supports the online calculation of the signals acquired in the system. The desired calculation is defined with the corresponding software dialog – manually or with the formula editor.

IPEmotion Version 1.03 and PlugIn IPETRONIK-LOG  $\geq$  V03.20 offer a shared formula editor, i.e. the following calculation functions are available in IPEmotion, as well as, in TESTdrive.



*Calculations, which are based on each other, must be run in the same cycle rate to get a correct result! If, e.g., the result of a calculation with low cycle rate is used in a calculation with higher cycle rate, a time offset results, which can influence the result according to a signal change (amplitude). In that case, the signal sampling rate of the first calculation must be raised.*

*The formula editor requires the use of the semicolon “;” instead of the comma “,” as variable separator.*

*If a value within a calculation is “NoValue“, the calculation result is “Novalue“, too.*

#### 7.1.1 Mathematic functions and operations

1 Basic operation				
Operator	Name	Syntax	Example	Result
+	Addition	“Temp01“ + “Temp02“	15 + 10	25
-	Subtraction	“Temp01“ - “Temp02“	15 - 10	5
*	Multiplication	“Temp01“ * “Temp02“	15 * 10	150
/	Division	“Temp01“ / “Temp02“	15 / 10	1.5
MOD	Modulo, Division rest	“Temp01“ MOD “Temp02“	15 MOD 10	5
ABS()	Absolute value of a number	ABS(“Temp01“)	ABS(-15)	15
SIGN()	Sign of a number	SIGN(“Temp01“)	SIGN(15) SIGN(0) SIGN(-15)	1 0 -1
NEG()	Negation of a number	NEG(“Temp01“)	NEG(15) NEG(-15)	-15 15
(	Begin bracket term	(“Temp01“ + “Temp02“) * 2	(15 + 10) * 2	50
)	End bracket term	(“Temp01“ - “Temp02“) * 2	(15 - 10) * 2	10

2 Power, Square root, Exponential and Logarithm functions				
Function	Name	Syntax	Example	Result
^	Power	“Temp01“ ^ 2	15 ^ 2	225
SQRT()	Square root	SQRT(“Temp01“)	SQRT(25)	5
EXP()	Exponential function of basis e	EXP(“Temp01“)	EXP(5)	148.41
LOG()	Logarithm of basis 10	LOG(“Temp01“)	LOG(5)	0,4771
LN()	Logarithm of basis e	LN(“Temp01“)	LN(5)	1.0986

3 Trigonometric functions, Hyperbola functions		
Function	Name	Range of values in radian
<b>SIN()</b>	Sine	+/-3.99 rad
<b>COS()</b>	Cosine	+/-3.99 rad
<b>TAN()</b>	Tangent	+/-3.99 rad
<b>ASIN()</b>	Arc sine	+/-1.0 rad
<b>ACOS()</b>	Arc cosine	+/-1.0 rad
<b>ATAN()</b>	Arc tangent	+/-1.0 rad
<b>SINH()</b>	Sine Hyperbolicus	+/-1.99 rad
<b>COSH()</b>	Cosine Hyperbolicus	+/-1.99 rad
<b>TANH()</b>	Tangent Hyperbolicus	+/-1.99 rad

4 Comparative operations (comparison of variable values)				
Function	Name	Syntax	Example	Result
<b>=</b>	Equal	"Temp01" = "Temp02"	15 = 10 15 = 15	0 1
<b>&lt;&gt;</b>	Unequal	"Temp01" <> "Temp02"	15 <> 10 15 <> 15	1 0
<b>&lt;</b>	Less than	"Temp01" < "Temp02"	10 < 15 15 < 15	1 0
<b>&gt;</b>	Greater than	"Temp01" > "Temp02"	15 > 10 15 > 16	1 0
<b>&lt;=</b>	Less than or equal	"Temp01" <= "Temp02"	10 <= 15 15 <= 15 20 <= 15	1 1 0
<b>&gt;=</b>	Greater than or equal	"Temp01" >= "Temp02"	15 >= 10 15 >= 15 15 >= 20	1 1 0
<b>IF( ; ; )</b>	If function	IF("Temp01" >= "Temp02"; x; y)  Query to a specific status. If Occurrence > action 1, otherwise action 2 Example: IF("Thermo_channel3" > 30; 1; 0) If Temperature > 30, Result: 1 otherwise 0 Action 1 and 2 can also be calculations.	x = 1; y = 0 "Temp01" = 15 "Temp02" = 10 "Temp01" = 10 "Temp02" = 15	1  0

5 Logic operations (comparison of signal states)				
Function	Name	Syntax	Example	Result
<b>AND</b>	And	"Temp01" > "Temp02" AND "Temp01" > 10	15 > 5 15 > 10 10 > 5	1 1 0
<b>OR</b>	Or	"Temp01" > "Temp02" OR "Temp01" > 10	15 > 5 10 > 5 10 > 10	1 1 0
<b>XOR</b>	Exclusiv or	"Temp01" > "Temp02" XOR "Temp01" > 10	15 > 5 10 > 5 15 > 15 10 > 10	0 1 1 0
<b>NOT( )</b>	Not	NOT("Temp01" > "Temp02") (inverse state)	15 > 5 15 > 15 5 > 15	0 1 1

6 Boolean operations (bitwise comparison of signal states)				
Function	Name	Description	Example	Result
<b>ANDB</b>	And bitwise	Bits which are set in operand1 <b>and</b> in operand2 will be set in the result (bit = 1), all others will be not set (bit = 0)	27 ANB 12 11011 ANDB 01100	8 01000
<b>ORB</b>	Or bitwise	Bits which are set in operand1 <b>or</b> in operand2 will be set in the result (bit = 1), all others will be not set (bit = 0)	26 ORB 8 11010 ORB 01000 27 ORB 13 11011 ORB 01101	26 11010 31 11111
<b>XORB</b>	Exclusive or bitwise	Bits which are set only in operand1 <b>or</b> only in operand2 will be set in the result (bit = 1), all others will be not set (bit = 0)	26 XORB 8 11010 XORB 01000 27 XORB 13 11011 XORB 01101	18 10010 22 10110
<b>NOTB</b>	Not bitwise	Bits which are set in operand1 will be not set in the result (bit = 0), all others will be set (bit = 1)	NOTB 27 NOTB 11011	4 00100

7 Statistic functions				
Function	Name	Syntax , Description	Example	Result
<b>MIN( )</b>	Minimum	MIN("Temp01")	4   12   3   25   17	3
<b>MAX( )</b>	Maximum	MAX("Temp01")	4   12   3   25   17	25
<b>MEAN( )</b>	Average	Average from all valid values		
<b>MEAN( ; )</b>	Average from n values	Average from n valid values		
<b>MINOR( ; )</b>	Less value	MINOR("Temp01"; "Temp02")	4   12	4
<b>MAJOR( ; )</b>	Greater value	MAJOR("Temp01"; "Temp02")	4   12	12
<b>FLOOR( )</b>	Round integer off	FLOOR("Temp01")	13,72	13
<b>CEIL( )</b>	Round integer up	CEIL("Temp01")	13,41	14
<b>ROUND( )</b>	Round integer	ROUND("Temp01")	13,41 13,72	13 14
<b>LIN( ; ; )</b>	Linearization	LIN("Temp01"; x node-1;y node-1; x node-n; y node-n) Runs a linearization with the defined nodes. Between n = 2 and n = 16 nodes can be defined.		

8 Other functions	
Function	Description
<b>EDGE_POS( )</b>	Detect positive edge 1 if current value is > 0 and the previous one <= 0
<b>EDGE_NEG( )</b>	Detect negative edge 1 if current value is <= 0 and the previous one > 0

Function	Description	Example	Result
<b>DIFF( )</b>	Runs a differentiation of an operand acc.to: (Opr1(t) – Op1(t-1)) * DeltaT		
<b>INT( )</b>	Calculates the integral of an operand acc. to: "((Op1(t) + Op1(t-1))/2) * DeltaT"		
<b>INT_ADD( )</b>	Calculates the integral of an operand acc. to: "((Op1(t) + Op1(t-1))/2) * DeltaT" and adds the result to the previous value		
<b>INT_UP( )</b>	Calculates the upper integral of an operand acc. to: "Op1(t) * DeltaT"		
<b>PREV( )</b>	Outputs the previous value.	PREV("Temp01") 4   12   3   25	NV   12   3
<b>(„Temp1“ + (PREV („Temp1“)) + (PREV (PREV („Temp1“))) ) / 3</b>	Floating average from the current value and both previous values		
<b>SHL( ; )</b>	Shift value bitwise to the left.	1 SHL 2 001 SHL 2	4 100
<b>SHR( ; )</b>	Shift value bitwise to the right.	12 SHR 1 1100 SHR 2	6 0110
<b>TESTBIT( ; )</b>	Checks the value (0, 1) of the defined bit. If the bit described by operand 2 is set, result = 1, otherwise result = 0 (Counting order starting right hand with 0)	TESTBIT(1101; 3) TESTBIT(1101; 1)	1 0
<b>TESTMASKS( ; )</b>	Makes a comparison with a user definable bitmask. If at least one bit is set in operand 1 and also in operand 2, result = 1, otherwise result = 0	TESTMASKS(27, 6) TESTMASKS(27, 4)	1 0
<b>TIME( )</b>	TIME("Temp01") A counter that adds the time intervals of the corresponding sample rate continuously and outputs the sum as long as the operator's value is >= 0.5 In case the operator's value is < 0.5, the counter is reseted and 0 is output.		
<b>TIMER( ; )</b>	If no new value is received from the channel defined as Parameter1 within the timeout (Parameter2 in seconds), the output value is '1'.		
<b>VALID( )</b>	Check for validity 1 if value is unequal to NoValue, 0 if value is NoValue		
<b>VALID(x; y)</b>	Avoid Novalues x if value is unequal to NoValue, y if value is NoValue		
<b>ISNOVALUE(x; y)</b>	Delay of a NoValue identification (x: signal value, y: optional time delay) If y is not set resp. its value is 0, the result is true, as soon as x = NoValue Is y ≠ 0 the result is true, as soon as x = NoValue for a minimum duration of y seconds. Is x ≠ NoValue, the result is always false.		
<b>RADIUS(y; z)</b>	Radius calculation polar coordinates ( $r = \sqrt{y^2 + z^2}$ ) = SQRT( "phi_y" * "phi_y" + "phi_z" * "phi_z" )		
<b>ANGLE(y; z)</b>	Angle calculation in polar coordinates = IF( "phi_z" >= 0; ACOS("phi_y" / "Radius" ) * 180/PI; -1 * ACOS("phi_y" / "Radius" ) * 180/PI + 360)		

### 7.1.2 Constants

9 Constants	
Constant	Description
PI	$\text{Pi} > \pi = 3.141592654 \dots$
SYSTEMRATE	TESTdrive internally works with a fix system rate. This rate depends on the configuration (Channel with highest sampling rate) and can be used for calculations. The system rate can be compared with the timer ticks of a PC clock and is set in Hz. The system rate relates to the working frequency of the PC/Notebook (= Frequency of the High-Performance-Counter).
SYSTEMTIME	Reciprocal value of the system rate ( $=1/\text{SYSTEMRATE}$ ) and is set in seconds. Please note at using a system rate in the MHz range that the system time can only be correctly displayed if sufficient decimals have been defined and Automatic has been selected in Display > Formatting.
SAMPLERATE	Channel sample rate in Hz
SAMPLETIME	Channel acquisition intervall in 1/s

### 7.1.3 NoValue and timeout settings

In order to differ invalid and valid measurement values, the user can select -FullScale, Null or +Fullscale (for analog inputs) to be identified as invalid value (NoValue). A signal value at the upper or lower limit range could be invalid, as it can not occur really. Another used case are missing messages at the CAN bus. An expired fimeout can be used to indicate invalid values.

### Settings possibilities

#### Measurement input

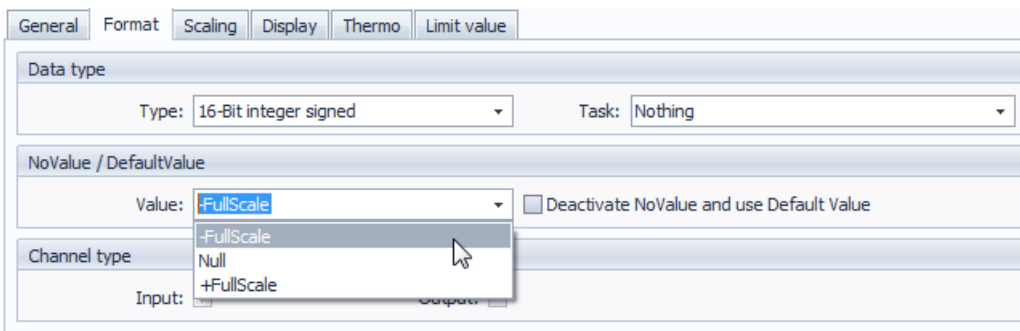

The setting for the signal input (e.g. IPETRONIK CAN measurement module) or the CAN signal input defines the invalid value (NoValue) within the measurement range (selection -FullScale, Null, +FullScale).

If this function is deactive, the measurement value is used (e.g. -60 °C with M-THERMO), NoValues are suppressed in this case.

A NoValue alarm can be activated for every signal within the **Format** tab.



### IPEmotion Options

The **IPEmotion Options Expert settings** (select **Basic settings > Expert mode**) provide a **No value timeout** for the online data acquisition. If values are missing with a cyclic data acquisition, subsequent samples will be output as NoValue if the timeout range has expired. The setting range for the No value timeout is 0 ... 5 s.

This setting has no effect on the data acquisition by the logger. Please use the PlugIn Options for this.

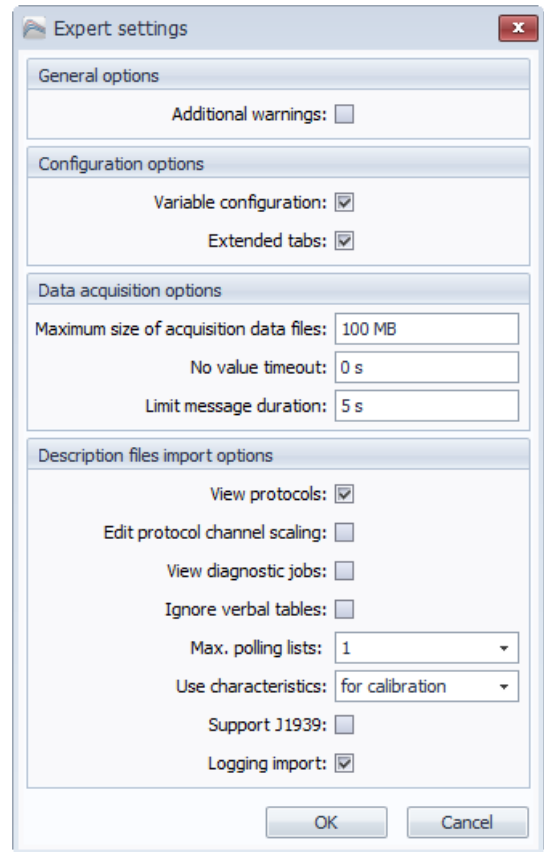

### PlugIn Options

Entering the **IPEmotion Options**, the options tab of the PlugIn IPETRONIK LOG (select **current PlugIn > Options > NoValue-Alarm Timeout (s)**) provides the logger acquisition timeout. . If values are missing with a cyclic data acquisition, subsequent samples will be output as NoValue if the timeout range has expired. The setting range for the No value timeout is 0 ... 120 s.

Conditioned by different delays during initialization (modules, logger) when measurement has been started, NoValues can occur during this phase. Use the setting **NoValue start delay (s)** in order to avoid NoValues at measurement start. The setting range for the No value start delay is 0 ... 600 s.

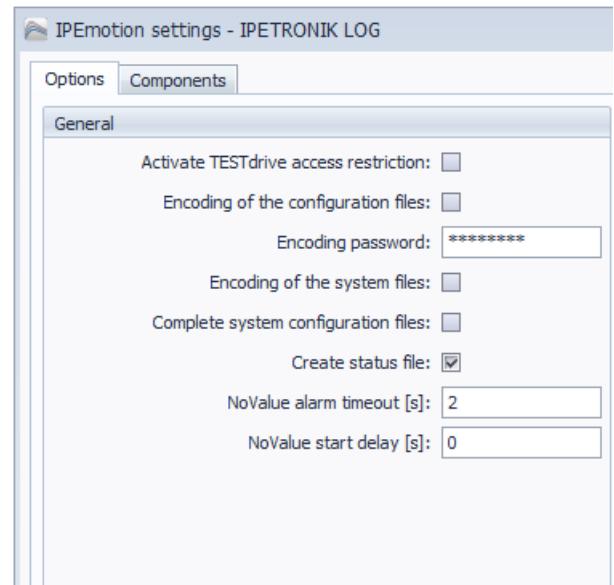

### CAN input

Each CAN input of the logger provides timeout settings with an adjustable delay time (select for example **CAN 02** > tab **Extended** > **Timeout value 2 s**). If the CAN input do not receive messages anymore and the timeout period has expired, the logger starts writing NoValues to the data record.

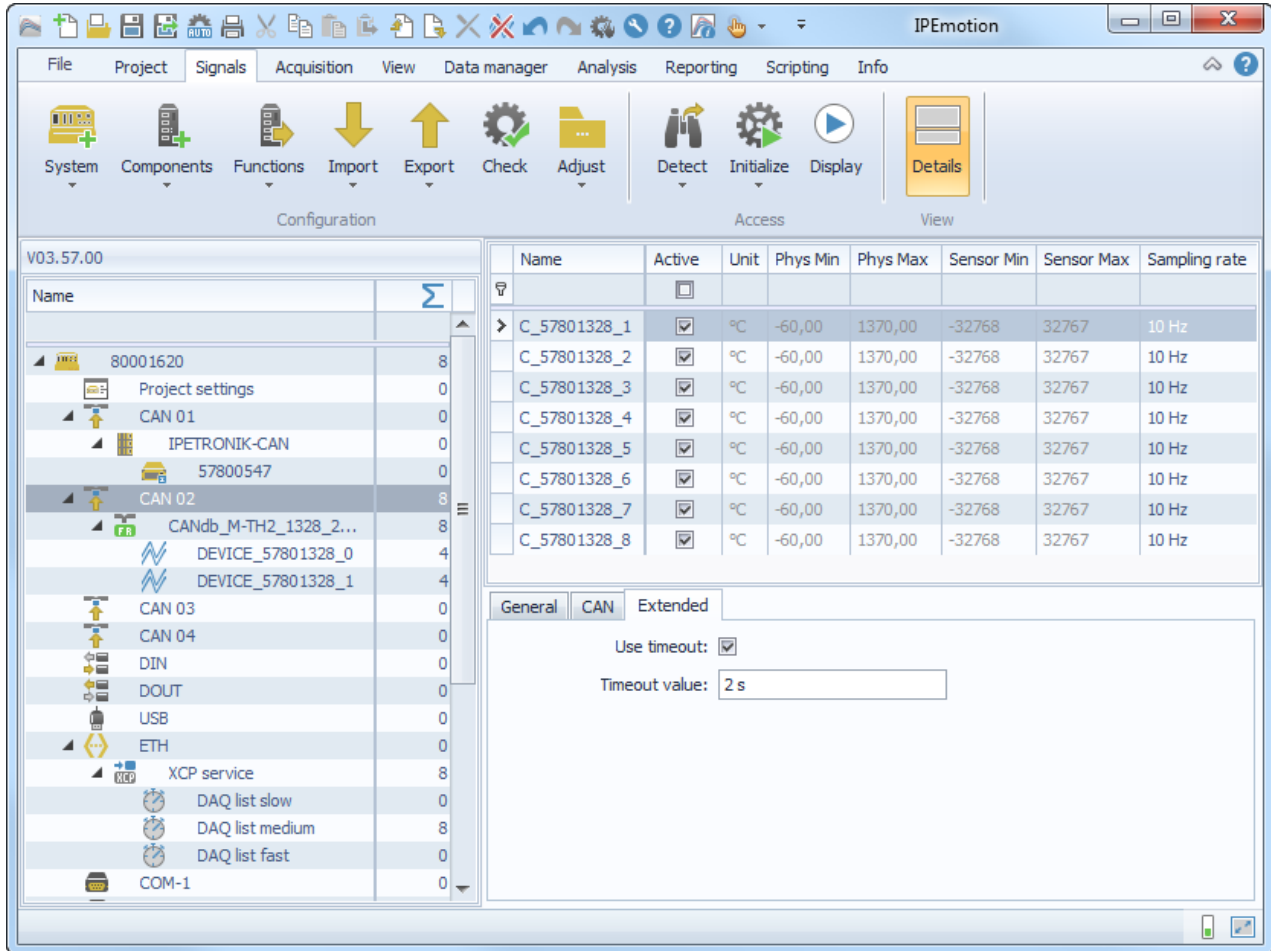

### Log file entries

If the NoValue monitoring is activated and NoValues are occurring, the system will record the series of NoValues itself (instead of the signal value) and the corresponding log file entry.

### Example

NoValue monitoring at CAN 01 Timeout value 20 s

Log file entry: *D CAN signal measurement timeout (no valid ID) on CAN 01 (t > 20000 ms)*

### 7.1.4 Calculation examples

#### Greater comparison „>“

**Syntax** >

**Description** Compares the current value (of a channel or a calculation) with a user defined constant or variable. The result is 1, as long as the comparison is true, otherwise the result is 0 (for a false comparison).

**Example** „Channel01“ > 2 *Comparison with a constant*  
 „Channel01“ > „Channel02“ *Comparison with a variable*

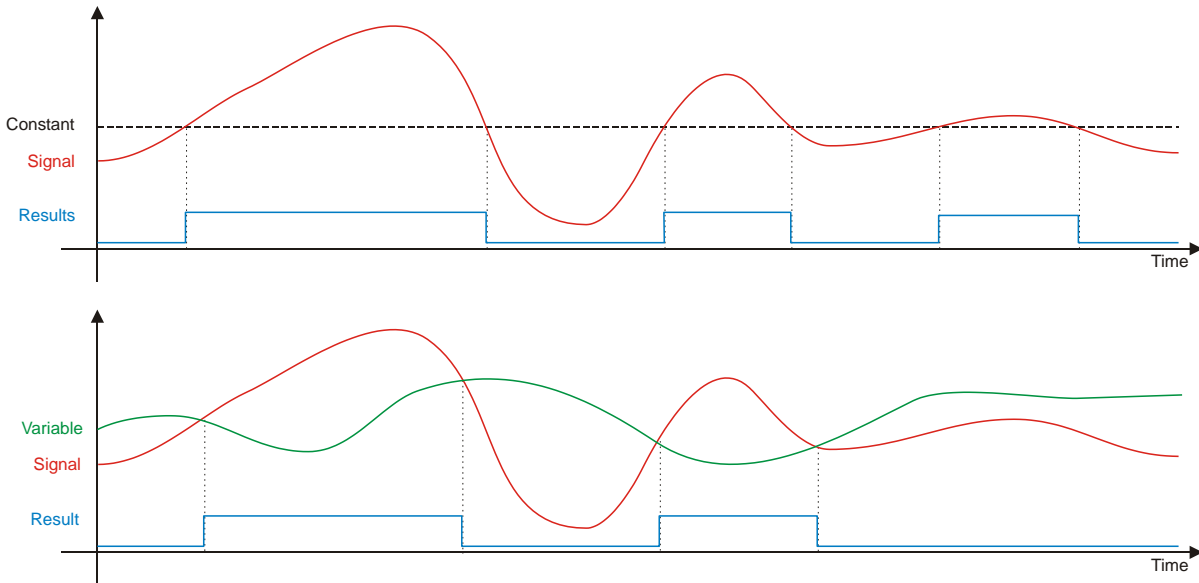

#### Less comparison „<“

**Syntax** <

**Description** Compares the current value (of a channel or a calculation) with a user defined constant or variable. The result is 1, as long as the comparison is true, otherwise the result is 0 (for a false comparison).

**Example** „Channel01“ < 2 *Comparison with a constant*  
 „Channel01“ < „Channel02“ *Comparison with a variable*

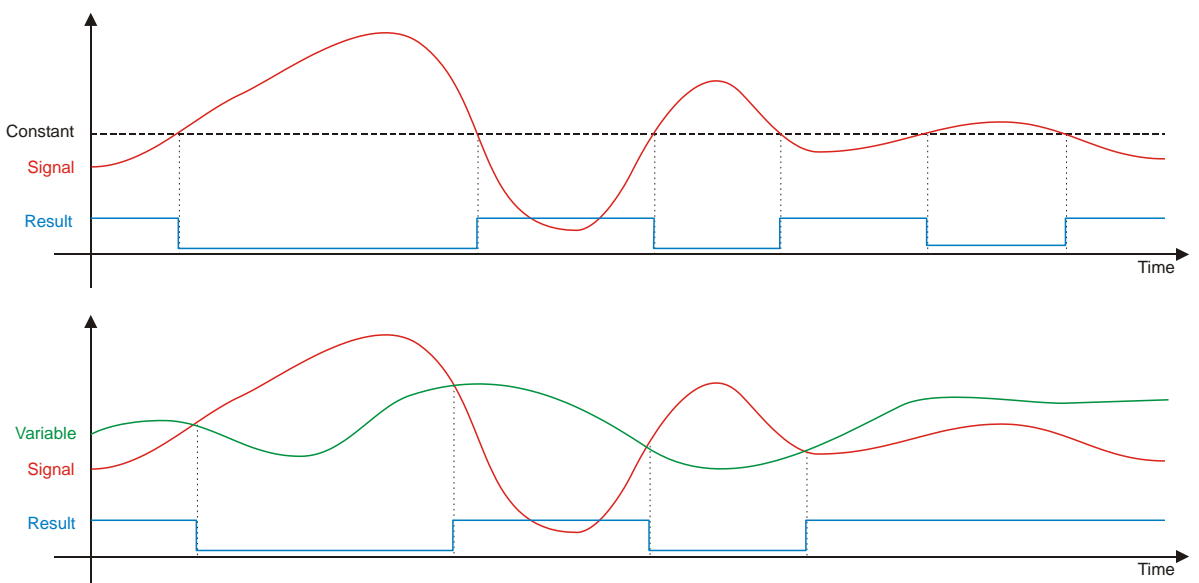

### Counter (without reset)

**Syntax** „Counter01“ + x  
VALID(“Counter01”; 0) + x

**Description** Counts continuously with the current sample rate, i.e. the counter value is increased by x with each sample. The rise of the counter slope depends on the currently configured sampling rate and the counter step. A measurement stop resets the counter to 0.

**Example** „Counter01“ = „Counter01“ + 1 *Accumulates 1 with each sample*  
„Counter01“ = „Counter01“ + 10 *Accumulates 10 with each sample*

**Tip** Used with TESTdrive (logger application) this recursive formula will result in valid values as the initial value for variables is set automatically. Used with IPEmotion (Acquisition > Calculations > Formulas) the respective formula has to be completed with the Valid function: „Counter01“ = VALID(„Counter01“; 0) + 1  
The Valid function sets the initial counter value to a defined value (here 0) in case the current value is invalid.

### Counter with counting condition

**Syntax** IF(“Channel01” > x; „Counter01“ + y; „Counter01“)  
IF(“Channel01” > x; VALID(“Counter01”; 0) + y; VALID(“Counter01”; 0))

**Description** Counts continuously with the current sample rate, as long as, the current value of "Channel01" is greater than x. The counter value is increased by y with each sample, as long as "Channel01" fulfills the condition. Otherwise the counter remains unchanged. As soon as the condition is fulfilled again, the counter continues with the previous value. The rise of the counter slope depends on the currently configured sampling rate and the counter step. A measurement stop resets the counter to 0.

**Example** „Counter01“ = IF(“Channel01” > 5; "Counter01" + 1; „Counter01“)  
*Accumulates 1 with each sample as long as "Channel01" is greater than 5.*  
*Stop counting and holding the latest value, as soon as „Channel01“ is less than 5.*

**Tip** Used with TESTdrive (logger application) this recursive formula will result in valid values as the initial value for variables is set automatically. Used with IPEmotion (Acquisition > Calculations > Formulas) the respective formula has to be completed with the Valid function.

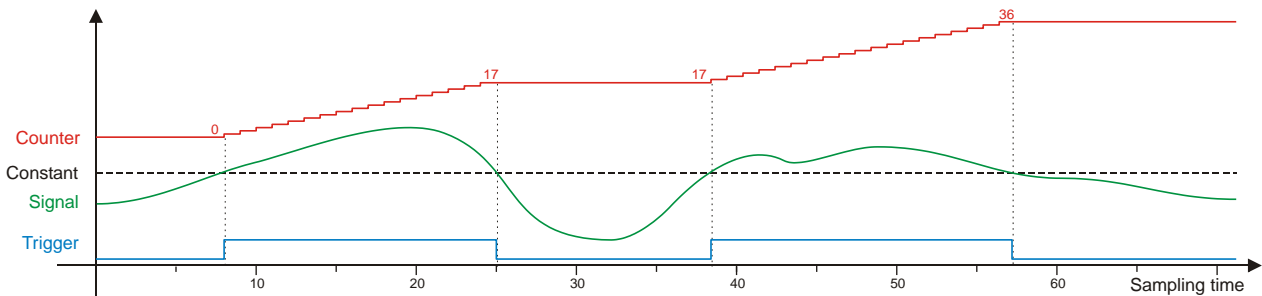

## Counter with counting condition and reset

**Syntax**      **IF("Channel01" > x; „Counter01“ + y; 0)**  
**IF("Channel01" > x; VALID("Counter01"; 0) + y; 0)**

**Description**      Counts continuously with the current sample rate, as long as, the current value of "Channel01" is greater than x. The counter value is increased by y with each sample, as long as "Channel01" fulfills the condition. Otherwise the counter will be reset to 0. As soon as the condition is fulfilled again, the counter restarts with 0. The rise of the counter slope depends on the currently configured sampling rate and the counter step. A measurement stop resets the counter to 0.

**Example**      „Counter01“ = IF("Channel01" > 5; „Counter01“ + 1; 0)  
*Accumulates 1 with each sample as long as "Channel01" is greater than 5.  
 Stop counting and reset to 0, as soon as „Channel01" is less than 5.*

**Tip**      Used with TESTdrive (logger application) this recursive formula will result in valid values as the initial value for variables is set automatically. Used with IPEmotion (Acquisition > Calculations > Formulas) the respective formula has to be completed with the Valid function.

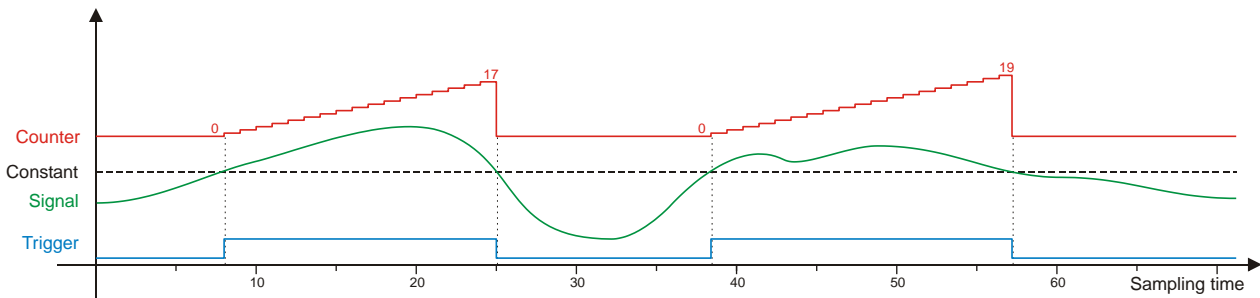

## Validation check „VALID“

**Syntax**      **VALID(x)**  
**VALID(x;y)**

**Description**      VALID checks the current value (of a channel or a calculation) for validity, i.e. if the variable's status is „invalid“ (NoValue).  
 With the VALID(x) function the result is 1, as long as x is valid and changes to 0, as soon as the x has the status NoValue.  
 With the VALID(x;y) function the result is x as long as x is a valid value. As soon as x will be an invalid value (NoValue) the result changes to y. In case y is a variable (instead of a constant) the result of VALID(x,y) will be NoValue, as soon as x, as well as, y are an invalid value.

**Example**      VALID(„Channel01“)    1 if „Channel01“ ≠ NoValue, 0 if „Channel01“ = NoValue  
 VALID(„Channel01“;4)    „Channel01“ if „Channel01“ ≠ NoValue, 4 if „Channel01“ = NoValue

**Tip**      When using a measurement value within a recursive formula ( $x = x + y$ ) we recommend to use the VALID(x; y) function in order to avoid invalid values (NoValue). Even if the measurement signal becomes valid values, the recursive formula will not be calculated correctly, once a NoValue occurred.  
 We recommend to use the VALID(x; y) function for any signal which serves as a trigger for a storage group. An invalid trigger signal could prevent the start of the data storage even if the trigger signal will become temporarily valid.

### Mean value (averaging) „MEAN“

**Syntax**      **MEAN(x)**  
                  **MEAN(x; n)**

**Description**    MEAN(x) continuously calculates the moving average from all valid measurement values.  
 MEAN(x; n) berechnet continuously calculates the moving average from n previous measurement values.

**Example**        MEAN(„Channel01“)                    moving average from all values of a measurement  
                  MEAN(„Channel01“; 10)            moving average from 10 values at a time

**Tip**              The diagram shows the differences of the MEAN functions with a rectangle signal (clock 5 Hz)

Square	red	origin signal
Mean Square	blue	moving average
Mean_5 Square	green	moving average from 10 values at a time

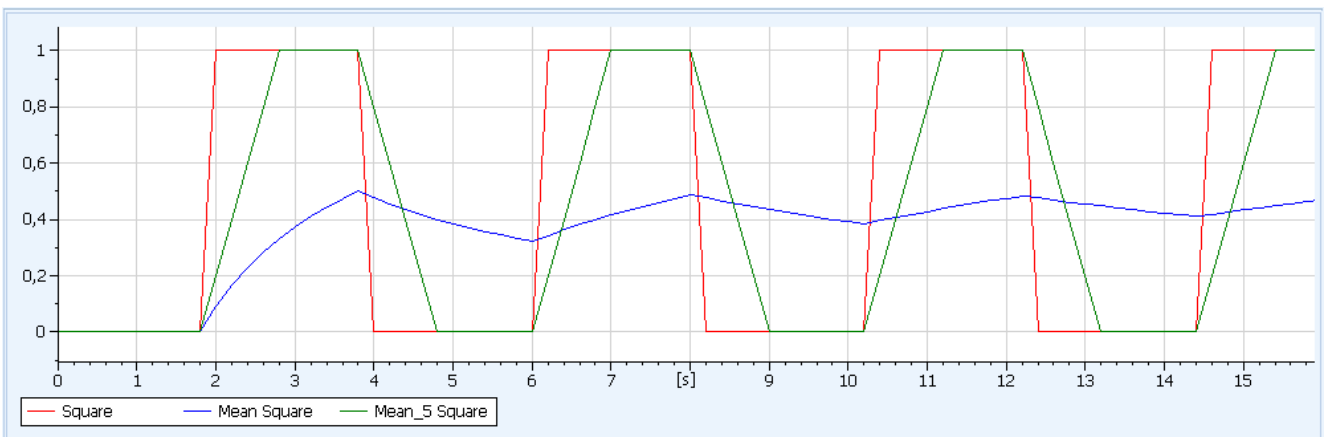

### Linearization „LIN“

**Syntax**        **LIN(Operand; x-Node01; y-Node01; x-Node02; y-Node02)**

**Description**    Runs a linearization with user defined nodes. Between n = 2 and n = 16 nodes can be defined. The scaled values (Y-axis) are calculated from the original measurement values (X-axis) using factor and offset of the partial linear slope between two nodes.

**Example**        LIN(„Channel01“; 0;-0,5; 2;1; 4;2; 8;2,5)

**Tip**              The linearization enables a non-linear scaling (multipart scaling) used for physical graphs without having a mathematical equation.  
 Using this multipart scaling an approximation of a mathematical equation is more precise as more nodes are used.

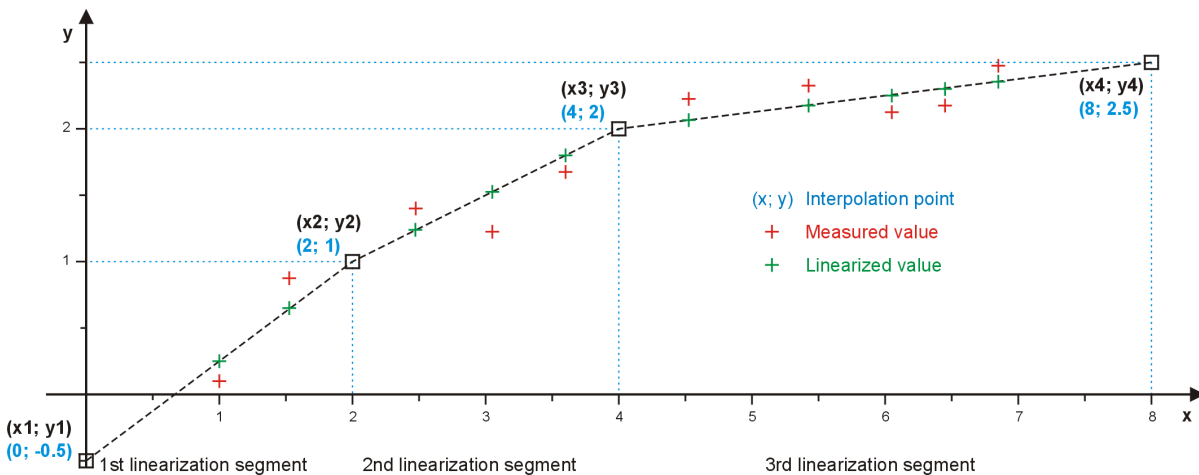

### 7.1.5 Calculation

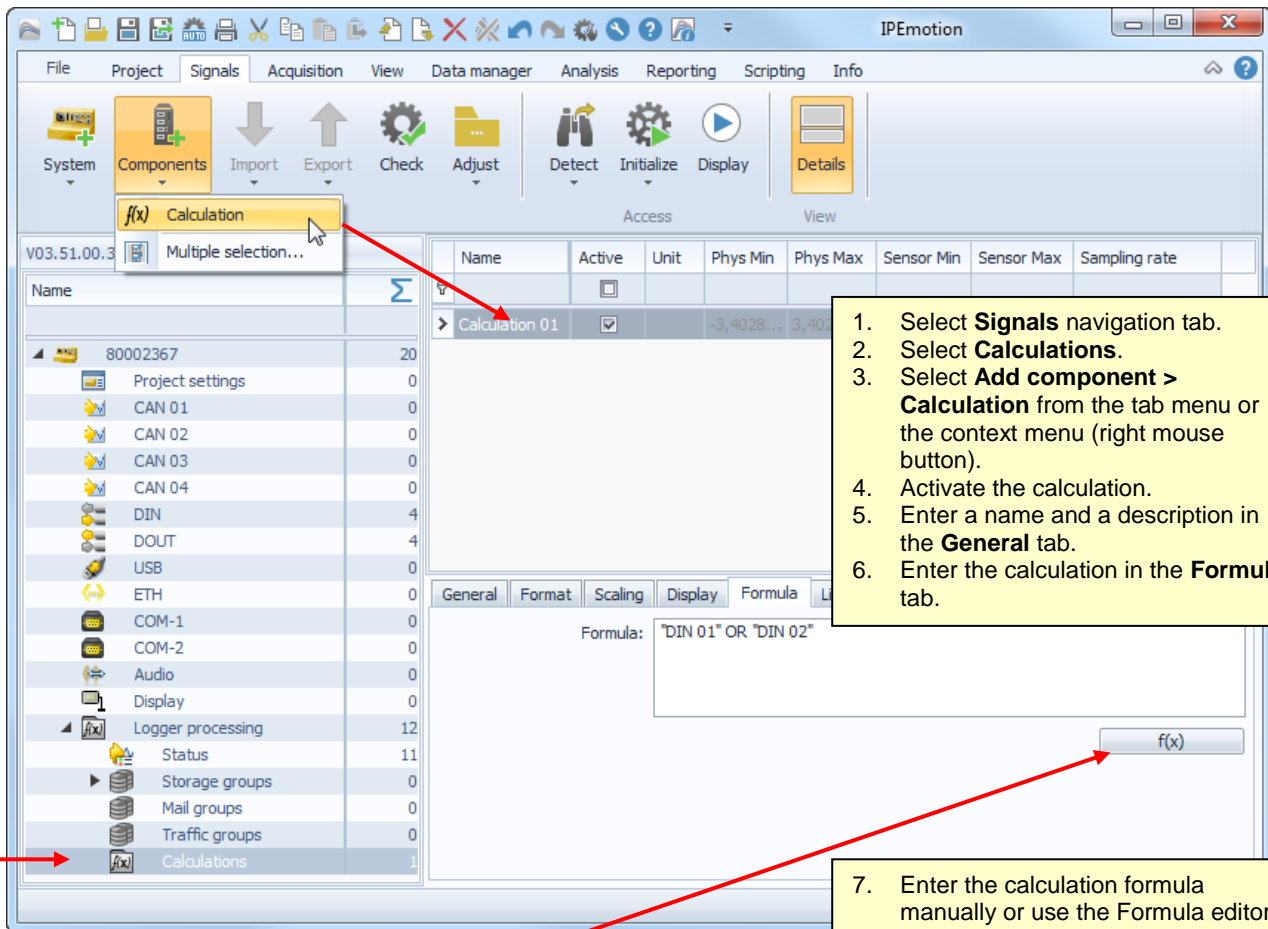

1. Select **Signals** navigation tab.
2. Select **Calculations**.
3. Select **Add component > Calculation** from the tab menu or the context menu (right mouse button).
4. Activate the calculation.
5. Enter a name and a description in the **General** tab.
6. Enter the calculation in the **Formula** tab.

7. Enter the calculation formula manually or use the Formula editor f(x).
8. Move signals and operators in the entry field by using Drag&Drop.
9. Confirm with OK.
10. Enter the value range and the decimals in the Display tab.
11. Define additional limit values and/or a NoValue.

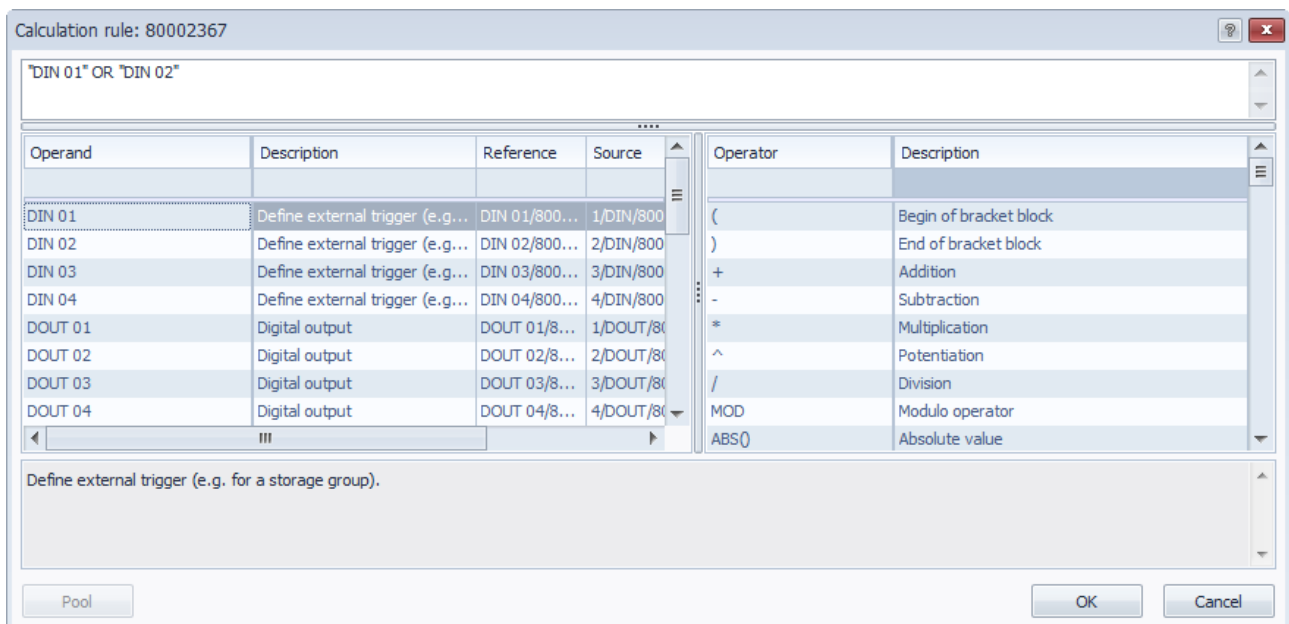
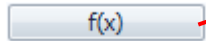

## 7.2 Digital inputs and outputs

### 7.2.1 Digital inputs

1. Activate the **Signals** tab.  
 2. Select **DIN** in the system overview.  
 3. Activate the desired digital inputs.  
 4. Enter a name and a description in the **General** tab.  
 5. Enter the value to be interpreted as NoValue in the **Format** tab. (Value out of the valid range)  
 6. Enter the value range and the decimals in the **Display** tab.  
 7. Define the lower and upper limit value with **Limit value**.  
 8. Enter the output/display of invalid value with **NoValue**.

### 7.2.2 Digital outputs

1. Activate the **Signals** tab.  
 2. Select **DOUT** in the system overview.  
 3. Activate the desired digital outputs.  
 4. Enter a name and a description in the **General** tab.  
 5. Enter the value to be interpreted as NoValue in the **Format** tab. (Value out of the valid range)  
 6. Enter the upper and lower acquisition range with **Scaling**.  
 7. Enter the value range and the decimals in the **Display** tab.  
 8. Define a formula to control the output with **Calculation**.  
 9. Define the lower and upper limit value with **Limit value**.



### Sampling rate DOUT

The logger's digital outputs (DOUT) support a definable sampling rate (cycle rate) of up to 100 Hz.

### Frequency output DOUT

If the frequency output is activated, a square wave voltage is sent. The signal frequency can be configured.

### 7.3 WakeOnCAN

The WakeOnCAN function switches the logger on as soon as the respective CAN bus is active, i.e. when messages are transferred.

#### 7.3.1 ON via WakeOnCAN, OFF via Ignition 15

If there is no **Switch-off time** configured, the remote signal (e.g. terminal 15) must be active within the set timeout to permanently switch-on the logger. The logger is turned off if the remote signal is not received after the timeout. The logger stays in operation mode as long as the remote signal is high. As soon as remote is low, the **Follow-up time** will start and the logger is switched-off when data postprocessing is finished.

Bridge Pin 3 (CAN2/6-GND) → Pin 6 (PWR-GND)  
 Bridge Pin 8 (WaOnCAN) → Pin 9 (UB-OUT+)

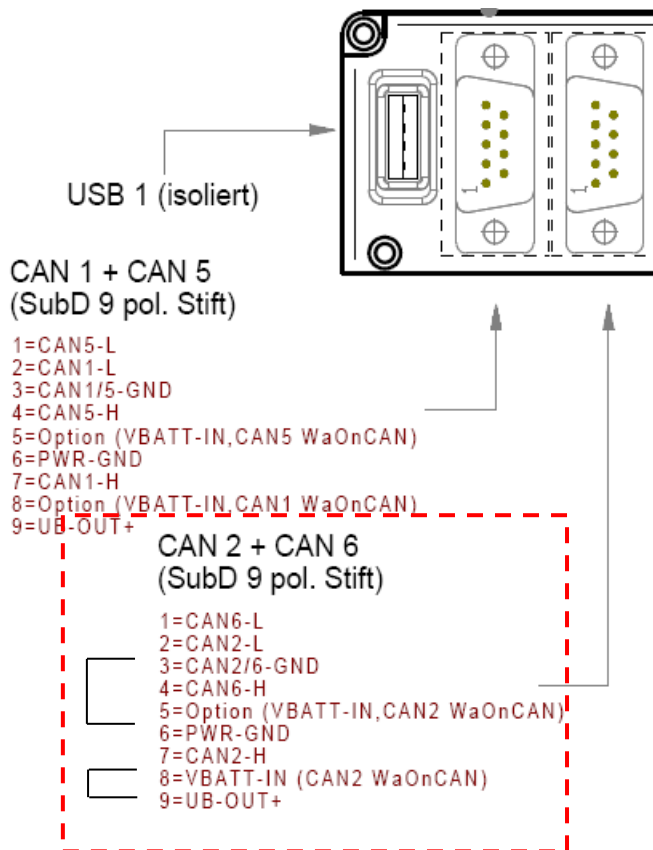
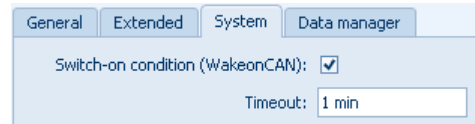

Depending on the CAN card/Port replicator, the WakeOnCAN function supports

- only at CAN 2,
- at CAN 2 and CAN 3
- at all CAN inputs (special version)!

#### 7.3.2 ON via WakeOnCAN, OFF via Switch-off condition

With a configured Switch-off condition the Timeout setting has no influence. The logger stays in operation mode as long as the Switch-off condition is false.

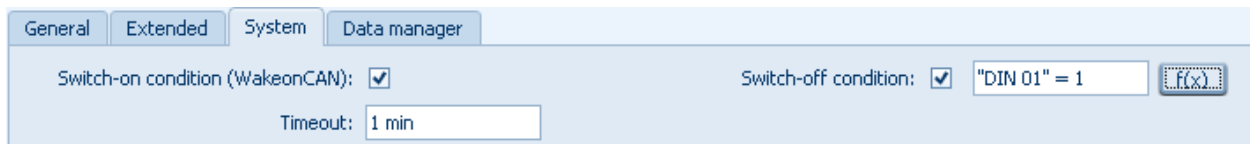

*If a temporary remote signal (duration > 1 s) is identified in this mode, the Follow-up time starts with the falling signal edge and the logger is switched off (when postprocessing is finished), even with a false Switch-off condition.*

## 7.4 CAN-Send: Output signals to CAN bus

The CAN-Send feature outputs measured signals, calculated channels and status signals using a common data rate up to 100 Hz. You can use the automatic CAN ID assignment or you may enter individual settings for each channel. Save the current signal settings to a CANdb file (\*.dbc) for a quick and easy exchange with the external application using the CANdb export feature.

**Requirements:**      **CAN board with FPGA version > 1.04.00**  
                                  **CAN-Send support for one CAN bus of the logger only**

At least one CAN participant must be connected to the CAN interface to transfer data to the CAN. If this is not the case, TESTdrive reports the following:

```
E Error sending CAN message in CANSendWorkStation. Counter = 1
```



*Just after successfully connecting a CAN device data output to the CAN bus is started, even when TESTdrive reports "Maximum number of error messages has been reached".*

### Creating CAN-Send, Adding channels

The screenshot shows the main configuration window of the software. On the left, a tree view shows the system structure with components like CAN 01, CAN 02, CAN 03, and CAN 04. A context menu is open over the 'CAN 01' component, with the 'Components' option selected. This opens a sub-menu where 'IPETRONIK-CAN' is highlighted, and its sub-menu is also open, showing 'CAN-Send' as the selected option. To the right, another context menu is open over the 'CAN-Send' component, with the 'Channels' option selected. A red arrow points from the 'CAN-Send' option in the sub-menu to the 'Channels' option in the context menu.

1. Highlight a CAN input (CAN 01)
2. Select **Components** and then **CAN-Send** from the tab menu or from the context menu (right mouse button).
3. Now, the system structure shows the new entry **CAN-Send** below the CAN input.
4. Select the channels you want to output to CAN bus.
5. If there are no active channels available, please activate some first and highlight **CAN-Send**. Select **Components > Channels** from the tab menu or from the context menu (right mouse button).

## CAN settings

**Sending frequency**                      common output rate of all signals: 0.5/ 1/ 2/ 5/ 10/ 20/ 50/ 100 Hz

If the data output rate is greater than or equal to the acquisition rate of source channel, this error report is written to the log file:

```
D ERROR in CCANSendWorkStation::Put() Fifo full!
```

- First CAN ID**                              Define the first CAN ID used for automatic CAN ID placing
- Automatic CAN ID placing**              Padding of CAN messages with selected signals and automatic CAN ID assignment to the respective message
- Send counter**                              Counts up the sending tasks
- Send counter start bit**                   Start bit used for the send counter value within the CAN message
- Send counter bit count**                   Data length of the send counter value
- Send counter data format**               Data format of the send counter value (Intel, Motorola forward)



*With automatic CAN ID placing, the first CAN message contains the value of the send counter (depending on data format byte 1 to 4).*

*Monitoring the send counter by the receiver is a simple way to verify a correct CAN communication.*

## Channel settings

- CAN message**                              Name of the CAN message
- CAN ID**                                      Identifier of the CAN message (standard ID and extended ID supported)
- CAN LSB**                                    Start bit within the CAN message of the signal to be output

### Extended settings (Expert mode only)

- Start bit**                                    Start bit within the CAN message of the signal to be output
- Bit count**                                   Number of bits per signal within the CAN message
- Data format**                                Data format of the signal value (Intel, Motorola forward)

## Exporting the settings to a CANdb

Export the current CAN send settings to a CANdb file after you finished the system configuration. This makes it easy to configure an external CAN device (notebook, or CAN data display) in order to acquire/display the signals streamed by the logger.

Channel	Index	Active	Unit	Sampling rate	CAN message	CAN ID [hex]	Start bit
57801482_1	1	<input checked="" type="checkbox"/>	°C	10 Hz	Message_100	100	32
57801482_2	2	<input checked="" type="checkbox"/>	°C	10 Hz	Message_100	100	48
58700695_1	3	<input checked="" type="checkbox"/>	V	100 Hz	Message_101	101	0
DIN 01	4	<input checked="" type="checkbox"/>		1 Hz	Message_101	101	16
DIN 02	5	<input checked="" type="checkbox"/>		1 Hz	Message_101	101	32
Delta T	6	<input checked="" type="checkbox"/>	°C	10 Hz	Message_101	101	48

The screenshot shows the IPEmotion software interface. On the left, a tree view shows the system configuration, with 'CAN-Send' highlighted. A context menu is open over 'CAN-Send', and the 'Export' option is selected, showing a sub-menu with 'CANdb export' highlighted. The main window displays a table of CAN messages with columns for Channel, Index, Active, Unit, Sampling rate, CAN message, CAN ID [hex], and Start bit. The 'Export' menu also shows options for 'XML CANdb export' and 'IPEmotion App export'.

1. Highlight **CAN-Send** from the system structure at the left side.
2. Select **Export > CANdb export** from the tab menu or from the context menu (right mouse button)..
3. Select destination and file name (\*.dbc) to save your export.
4. Confirm by clicking the **Save** button.

## 7.5 Log file output via Hyperterminal

The logger status messages can be displayed online with a RS232 PC or notebook connection. The MLOG.ht file is copied into the following directory:

C:\Documents and Settings\[user]\Startmenu\Programs\Accessories\Communication\HyperTerminal\....

Prior to this, a hyperterminal connection must be created.

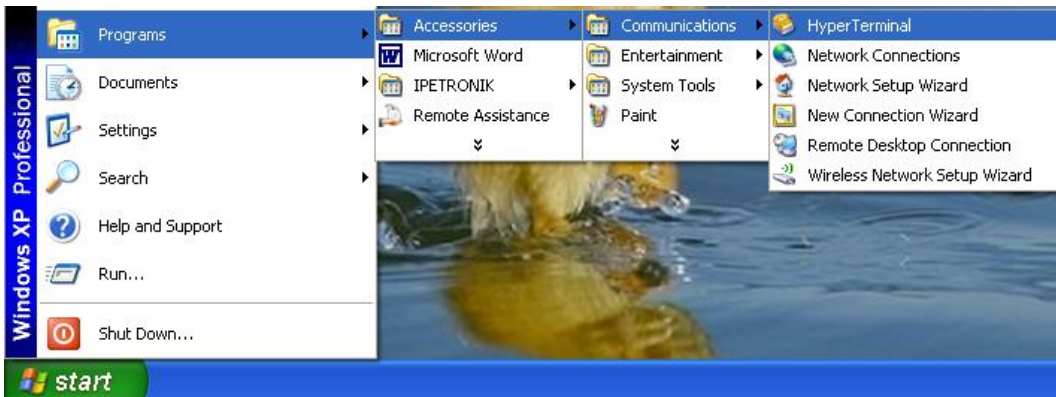

Or create a new hyperterminal connection:



The following components are required for the connection of M-LOG and PC:

**for PCs with serial interface:**

1 x USB to RS232 converter

1 x Null modem cable

1 x Gender Changer

**for PCs without serial interface:**

2 x USB to RS232 converter

1 x Null modem cable

1 x Gender Changer

The components for PCs without serial interface are available as an optional package (M-LOG-OPT-086).

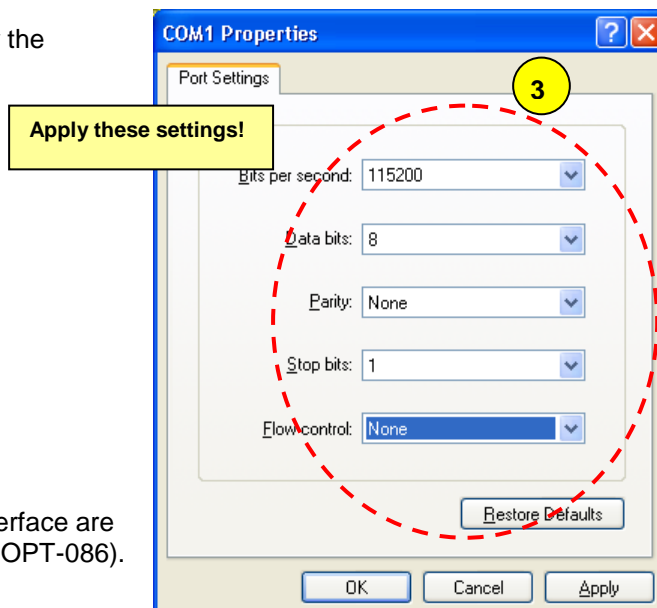

## 7.6 Send e-mail with status information

If this function is activated and the logger has an internet connection (LAN, WiFi, modem), it sends a status e-mail after acquisition stop with the following content:

- ▶ serial number and number of the current acquisition in subject line,
- ▶ attached log file
- ▶ attached measurement status file if activated
- ▶ attached STG file (Statistic Group, resp. Min-Max list) if activated

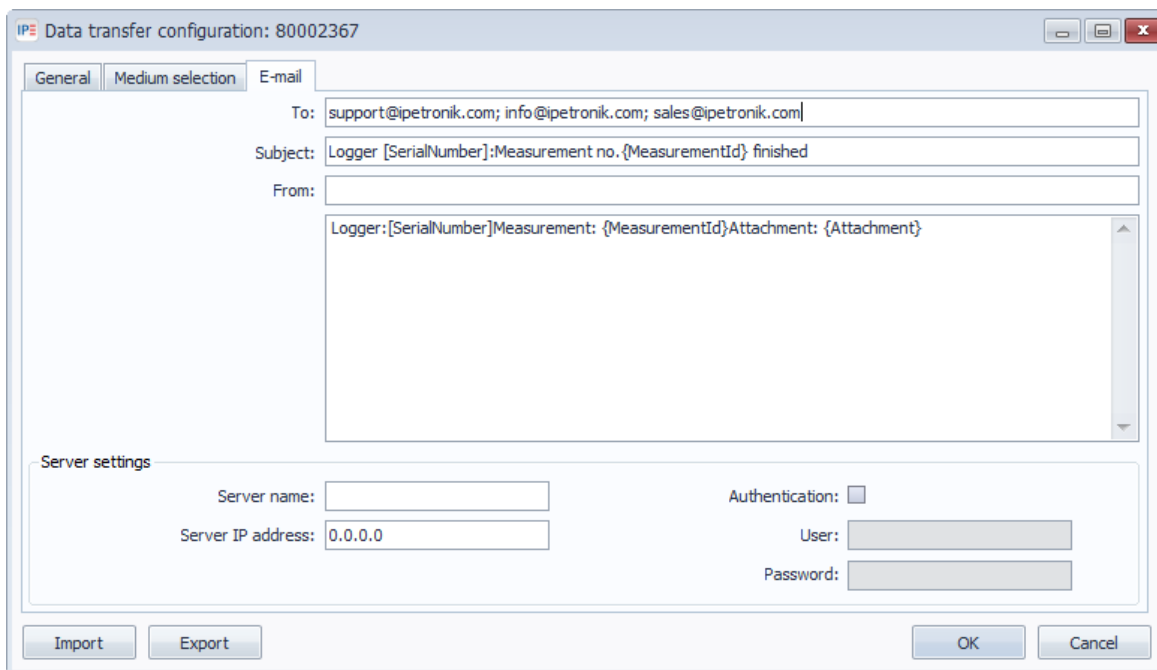
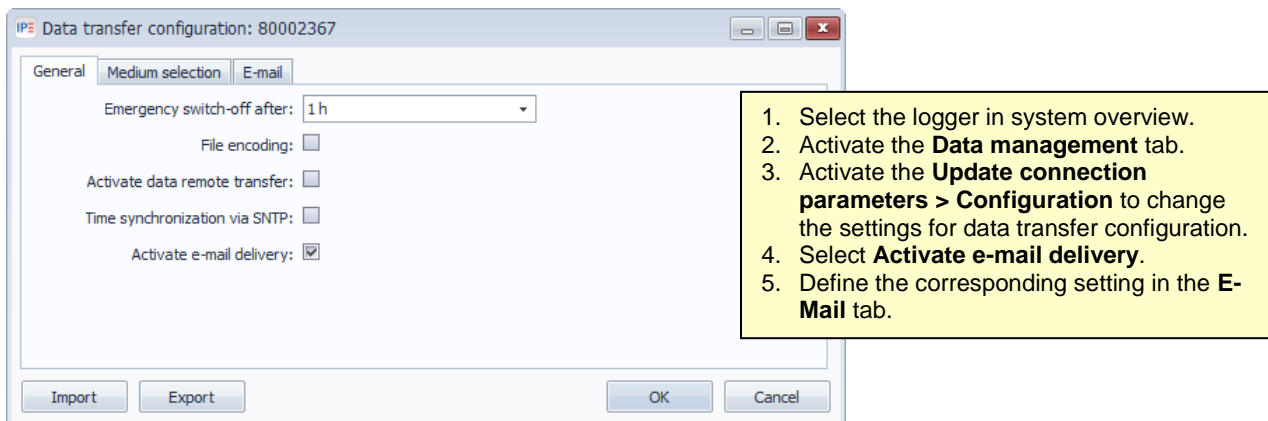

<b>To</b>	E-mail address of recipient
<b>Subject</b>	Subject line for serial number and measurement number file
<b>From</b>	E-mail address of sender (any text)
<b>Description field</b>	Description of serial number, measurement file number and attachment
<b>Server IP address</b>	IPE address of outgoing mail server (to e-mail account, e.g. smtp.mail.provider.com) for sending
<b>Server name</b>	Alternative input of server name of outgoing mail server
<b>Authentication</b>	Access authorization to user e-mail account
User	User name
Password	Password

## 7.7 Output messages to CAN / LIN

With the Logger PlugIn V03.21.00 / TESTdrive 3.21 and higher an output of user defined messages to CAN bus or LIN bus is supported.

The output timing can be selected from:

- one-time, at start measurement,
- one-time, at stop measurement,
- cyclical every x ms.

An external file with the \*.DAT extension is used to configure the settings for the messages.

A sample file is available from:

**c:\Programs\IPETRONIK\IPEmotion PlugIn IPETRONIK LOG V03.xx.xx\Data\Channel.dat**

The header of this files contains detailed information regarding to the usage of the parameters.

The screenshots below show the implementation of the external file in IPEmotion configuration.

The screenshot shows the 'Systems' overview window. The 'Data processing' component is selected in the left pane. A context menu is open over it, showing options like 'Add components', 'Change into', 'Extras', 'Import', 'Export', 'Use as default', 'Cut', 'Copy', 'Paste', 'Paste behind', 'Delete', 'Clean', and 'Properties'. A secondary menu is also visible, showing 'Statistic', 'External programs', 'Event handling', and 'Multiple selection...'. A yellow callout box contains the following instructions:

1. Select **Data processing** in the left Systems overview.
2. Select **Add components > External programs** from the tab menu or from the context menu.
3. The new entry **External programs** has been added to **Data processing**.

The screenshot shows the 'Systems' overview window after the configuration. The 'Data processing' component is still selected, and a sub-component 'External programs' has been added to it. The context menu is open, showing the 'Add components' option. A secondary menu is also visible, showing 'Runtime library' and 'Multiple selection...'. A yellow callout box contains the following instructions:

4. Select **External programs** in the left Systems overview.
5. Select **Add components > External programs** from the tab menu or from the context menu.
6. Chose additional settings in the tab **Extended**.



**Example Offset adjust for IPETRONIK modules connected to the logger’s CAN input**

The message output feature offers the possibility to broadcast an offset adjust command to IPETRONIK CAN modules with adjust function.

The sample file **OffAddStart.dat** contains the adjust commands for task Manual and Group 1-4. The sample shows a manual adjust on CAN 01 with a baud rate of 500 kBit/s, executed with a time delay of 2.5 seconds from start measurement.

Brief description of the parameters (see header of the sample Channel.dat for detailed settings):

```
// Hardware initialization <---Basic setting of CAN/LIN input
[Init]
// Channel,   ChnType,   ChnIndex,   ChnMode,   Baudrate
CAN0,        1,         0,          1,         500000
<-----ChnType LIN=2 /CAN=1, ChnIndex Nr 0...11=Input , ChnMode 29Bit=2 11Bit=1 / Baud rate

// List of messages (send/receive)
[Messages]
// Name, ID, Length Bytes <----- ID CAN/LIN -ID; Length= Number of bytes; Bytes = Message
//
Manuell_1,   0x0, 8,         0x00, 0x91, 0x02, 0xCA, 0x3F, 0x00, 0x80, 0x80      <----Manual
Manuell_2,   0x0, 8,         0x00, 0x91, 0x02, 0xCA, 0x3F, 0x00, 0xC0, 0x81
Manuell_3,   0x0, 8,         0x00, 0x91, 0x02, 0xCA, 0x3F, 0x00, 0x40, 0x8C
Manuell_4,   0x0, 8,         0x00, 0x91, 0x02, 0xCA, 0x3F, 0x00, 0xC0, 0x8D
Manuell_5,   0x0, 8,         0x00, 0x91, 0x02, 0xCA, 0x3F, 0x00, 0x00, 0x8E
Group1_1,    0x0, 8,         0x00, 0x91, 0x02, 0xC5, 0x3F, 0x00, 0x80, 0x80      <-----Group 1
Group1_2,    0x0, 8,         0x00, 0x91, 0x02, 0xC5, 0x3F, 0x00, 0xC0, 0x81
Group1_3,    0x0, 8,         0x00, 0x91, 0x02, 0xC5, 0x3F, 0x00, 0x40, 0x8C
Group1_4,    0x0, 8,         0x00, 0x91, 0x02, 0xC5, 0x3F, 0x00, 0xC0, 0x8D
Group1_5,    0x0, 8,         0x00, 0x91, 0x02, 0xC5, 0x3F, 0x00, 0x00, 0x8E
Group2_1,    0x0, 8,         0x00, 0x91, 0x02, 0xC6, 0x3F, 0x00, 0x80, 0x80      <-----Group 2
Group2_2,    0x0, 8,         0x00, 0x91, 0x02, 0xC6, 0x3F, 0x00, 0xC0, 0x81
Group2_3,    0x0, 8,         0x00, 0x91, 0x02, 0xC6, 0x3F, 0x00, 0x40, 0x8C
Group2_4,    0x0, 8,         0x00, 0x91, 0x02, 0xC6, 0x3F, 0x00, 0xC0, 0x8D
Group2_5,    0x0, 8,         0x00, 0x91, 0x02, 0xC6, 0x3F, 0x00, 0x00, 0x8E
Group3_1,    0x0, 8,         0x00, 0x91, 0x02, 0xC7, 0x3F, 0x00, 0x80, 0x80      <-----Group 3
Group3_2,    0x0, 8,         0x00, 0x91, 0x02, 0xC7, 0x3F, 0x00, 0xC0, 0x81
Group3_3,    0x0, 8,         0x00, 0x91, 0x02, 0xC7, 0x3F, 0x00, 0x40, 0x8C
Group3_4,    0x0, 8,         0x00, 0x91, 0x02, 0xC7, 0x3F, 0x00, 0xC0, 0x8D
Group3_5,    0x0, 8,         0x00, 0x91, 0x02, 0xC7, 0x3F, 0x00, 0x00, 0x8E
Group4_1,    0x0, 8,         0x00, 0x91, 0x02, 0xC8, 0x3F, 0x00, 0x80, 0x80      <-----Group 4
Group4_2,    0x0, 8,         0x00, 0x91, 0x02, 0xC8, 0x3F, 0x00, 0xC0, 0x81
Group4_3,    0x0, 8,         0x00, 0x91, 0x02, 0xC8, 0x3F, 0x00, 0x40, 0x8C
Group4_4,    0x0, 8,         0x00, 0x91, 0x02, 0xC8, 0x3F, 0x00, 0xC0, 0x8D
Group4_5,    0x0, 8,         0x00, 0x91, 0x02, 0xC8, 0x3F, 0x00, 0x00, 0x8E
```

[Conditions]

// Name Condition

// Messages which have to be send at measurement start <---- **The output sequence is defined by the sequence of the list**

[OnStart]

// Time, Channel, Message

2500000, CAN0, Manuell\_1

**<-- 2500000 µs after Start /CAN input/ To adjust a group, replace with Group1\_1**

2500000, CAN0, Manuell\_2

**<-- 2500000 µs after Start /CAN input/ To adjust a group, replace with Group1\_2**

2500000, CAN0, Manuell\_3

**<-- 2500000 µs after Start /CAN input/ To adjust a group, replace with Group1\_3**

2500000, CAN0, Manuell\_4

**<-- 2500000 µs after Start /CAN input/ To adjust a group, replace with Group1\_4**

2500000, CAN0, Manuell\_5

**<-- 2500000 µs after Start /CAN input/ To adjust a group, replace with Group1\_5**

Refer to the header of the \*.DAT file for further parameter settings.

## 7.8 Event controlled measurement

### 7.8.1 Possibilities for data acquisition

For measurement signal acquisition and storage in electronic systems, analog signals need to be digitalized, first. This is done by taking discrete measuring values from the continuous signal sequence (Sample & Hold) and recording them cyclically. Cyclic recording is also used for native digital signals, e.g. for measuring data packages from bus systems.

For some applications, it is useful to not record CAN bus data cyclically but event-controlled.

In the following, the basic features of both data acquisition types are described.

## 7.8.2 Cyclic data recording of continuous signals

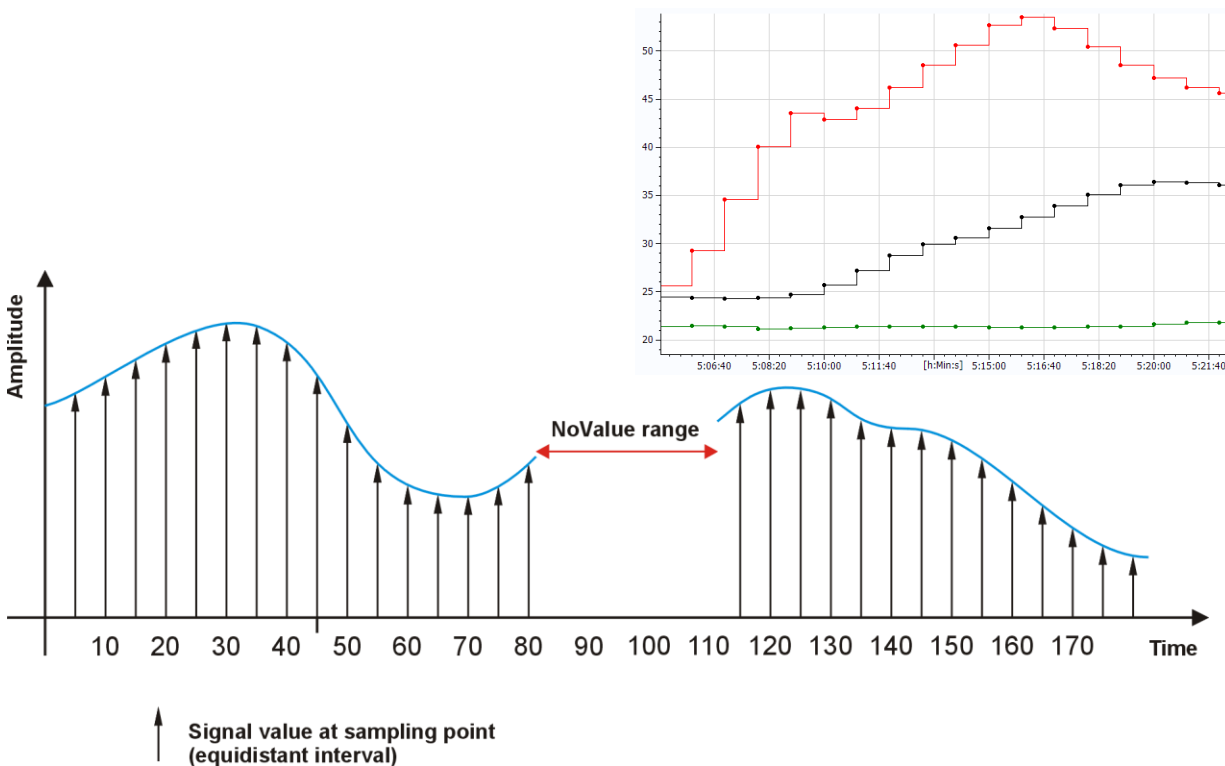

### Features of cyclic data recording (PlugIn IPETRONIK-LOG)

- ▶ time-based recording in a fixed time grid, e.g. sampling rate 100 Hz
- ▶ different storage groups allow different data rates for recording
- ▶ individual time channel for each storage group in measurement data set
- ▶ continuous recording in equidistant intervals
- ▶ suitable for analog signals
- ▶ improved time accuracy due to increased sampling rate (oversampling)
- ▶ clear comparability of different signals using a synchronization clock (Master Sample Clock MSC)
- ▶ protocol measurement during data acquisition using bus systems is possible (CCP, XCP, FlexRay, ...)
- ▶ bus signals are allocated to the respective time grid (sampling rate)
- ▶ (time) differentiation of two signals is not possible in the time grid
- ▶ sampling points without real signal value are indicated with "NoValue" (invalid) in data set

### 7.8.3 Event-controlled data recording of bus signals

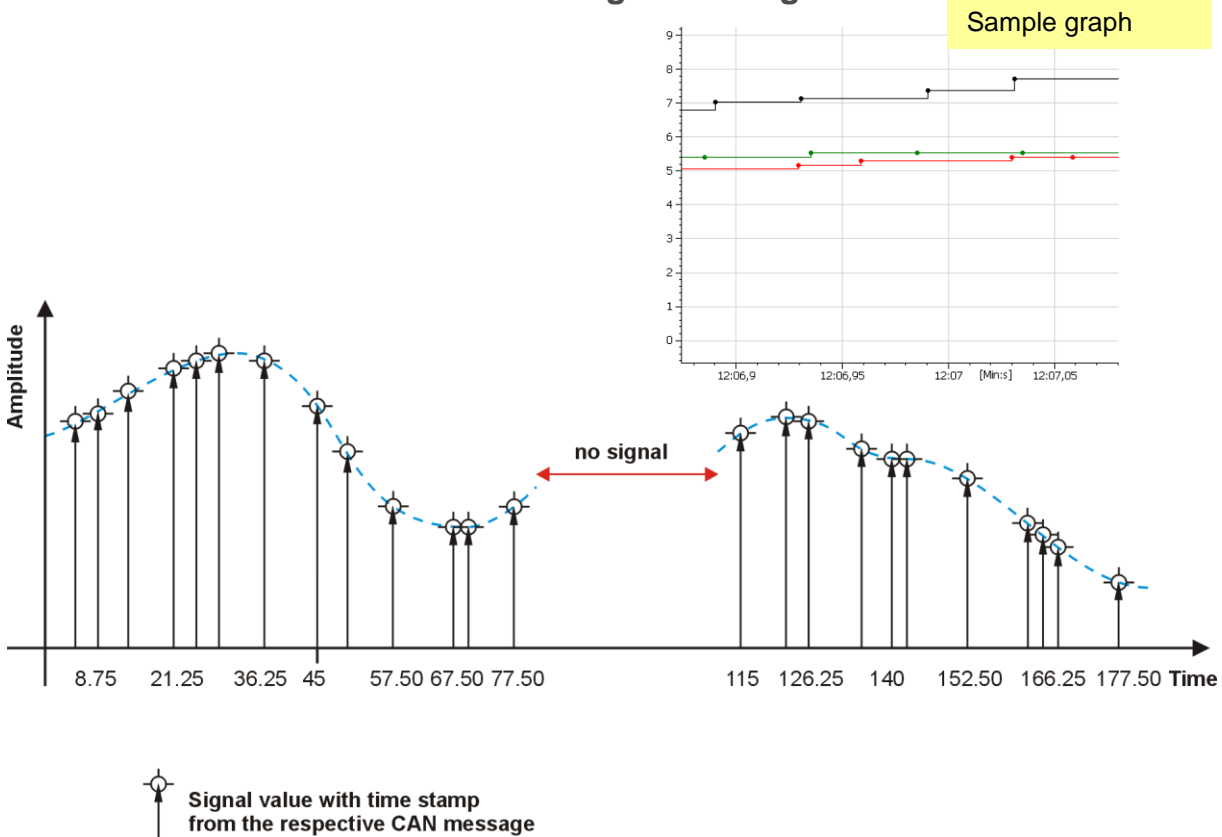

#### Features of event-controlled data recording (PlugIn IPETRONIK-LOG)

- ▶ event-controlled recording without fixed time grid for bus signals, e.g. CAN bus
- ▶ all signals of a message are provided with an exact time stamp, as with traffic measurement
- ▶ individual time channel for each message in measurement data set
- ▶ discontinuous recording without defined time grid
- ▶ suitable for measurement of bus signal differences and of sporadic or single signals
- ▶ measuring values in different messages feature different time stamps > in the result graph, the time stamps do not lie on the same x-values any more
- ▶ no protocol measurement possible (CCP, XCP; FlexRay, ... )
- ▶ determination of exact time difference between signals (difference between time stamps)
- ▶ "NoValue" entries indicating the absence of signals are avoided

### 7.8.4 Setting up event-controlled data recording (PlugIn IPETRONIK-LOG)

#### General

Event-controlled measurement, available from TESTdrive 3.51.00 onwards, features the benefits of signal measurement and traffic measurement:

Signal selection is already interpreted (name, scaling, unit,...). Yet, measurement is not performed cyclically but with "real" time stamp. Signals are only recorded if they really are present on the CAN bus. Using the exact time stamp.

Event-controlled measurement appears like a signal measurement on the configuration surface and in the measurement file. Loggers process the respective storage groups in traffic measurement mode.

#### Configuration settings

The respective signals must not be recorded cyclically.

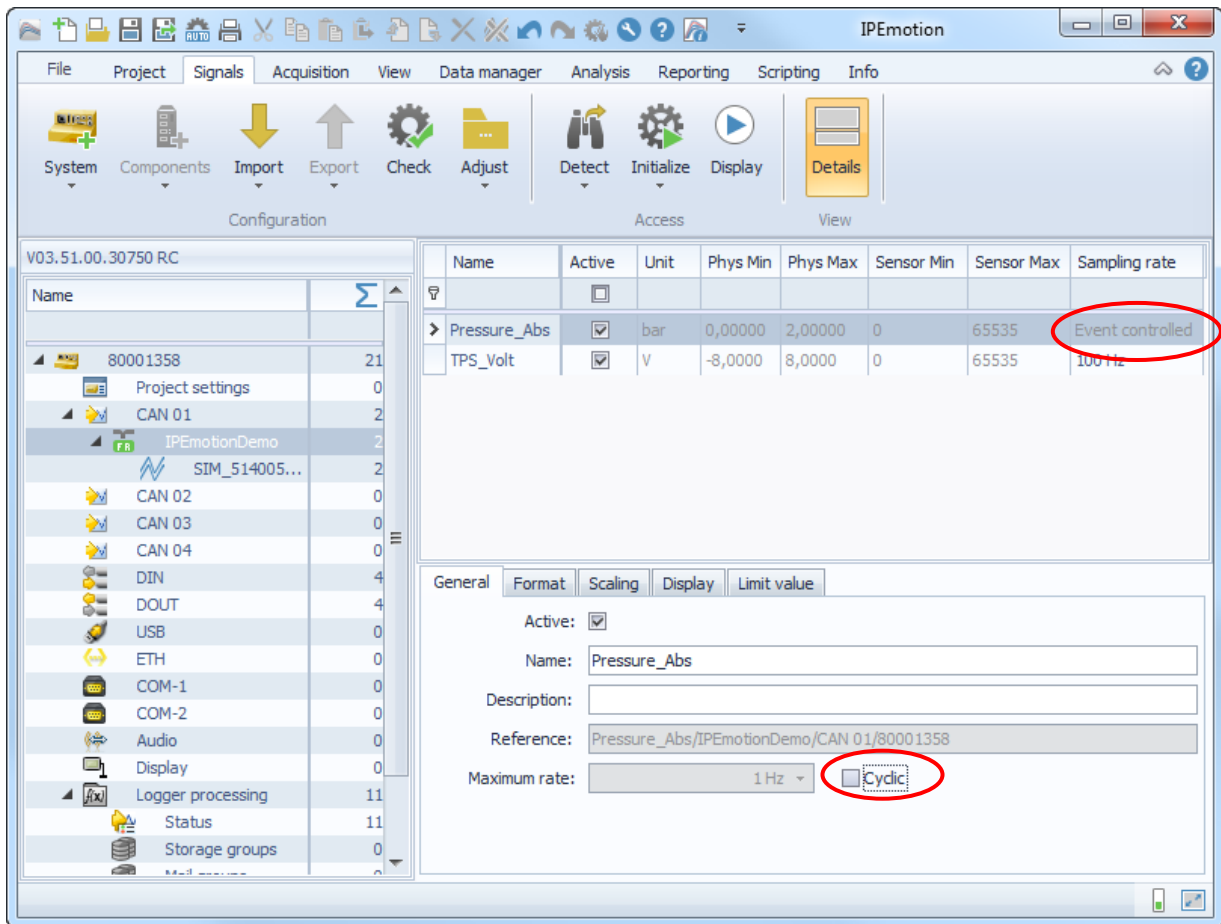

In the storage group, the storage rate has to be set **From channel**. It should not be a fixed storage rate.

As a result, sampling rate is **Event controlled** and storage rate is **Auto**.

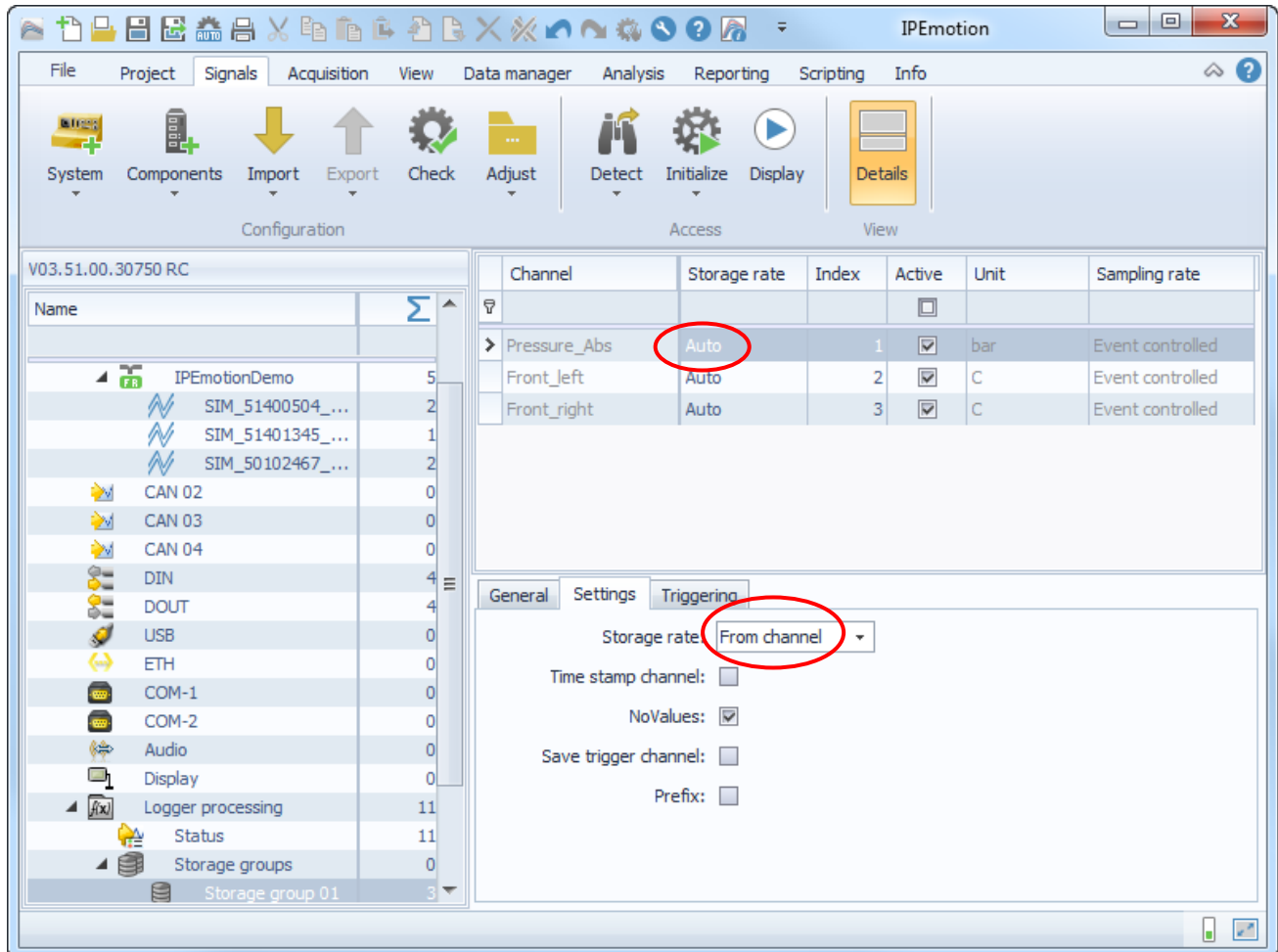

## Measurement file

Event-based signals are recorded in an event-based storage group TS\_xxxxxx.DAT. A signal-based storage group DOxxxxxx.DAT with cyclic storage rate cannot contain event-based signals since event-controlled or cyclic recording types are properties of signals and not of storage groups.

### There are two types DAT files:

- ▶ DOxxxxxx.DAT for storage groups with cyclic storage rate and signals with fixed, cyclic sampling rate
- ▶ TSxxxxxx.DAT for storage groups with event-controlled, non-cyclic signals without fixed sampling rate

Name	Erw.	Größe
BAD-IP_26_80900023_20130629_114253_02_Loggerstatus_D0021813	DAT	20.901
BAD-IP_26_80900023_20130629_114253_02_Loggerstatus_D0021813	I8	5.891
BAD-IP_26_80900023_20130629_114253_02_Loggerstatus_D0021813	T64	47.161
BAD-IP_26_80900023_20130629_114253_02_Loggerstatus_D0021813	W16	353.761
BAD-IP_26_80900023_20130629_114253_02_Loggerstatus_D0021813	W32	141.501
BAD-IP_26_80900023_20130629_114253_02_Loggerstatus_D0021813	W8	53.061
BAD-IP_26_80900023_20130629_114253_03_Fahrzeugstatus_D0031813	DAT	67.081
BAD-IP_26_80900023_20130629_114253_03_Fahrzeugstatus_D0031813	I16	41
BAD-IP_26_80900023_20130629_114253_03_Fahrzeugstatus_D0031813	R32	41
BAD-IP_26_80900023_20130629_114253_03_Fahrzeugstatus_D0031813	T64	31
BAD-IP_26_80900023_20130629_114253_03_Fahrzeugstatus_D0031813	W16	21
BAD-IP_26_80900023_20130629_114253_03_Fahrzeugstatus_D0031813	W32	41
BAD-IP_26_80900023_20130629_114253_03_Fahrzeugstatus_D0031813	W8	431
BAD-IP_26_80900023_20130629_114253_04_Vollumfang_getriggert_D0041813	DAT	159.131
BAD-IP_26_80900023_20130629_114253_04_Vollumfang_getriggert_D0041813	I16	1
BAD-IP_26_80900023_20130629_114253_04_Vollumfang_getriggert_D0041813	R32	1
BAD-IP_26_80900023_20130629_114253_04_Vollumfang_getriggert_D0041813	T64	1
BAD-IP_26_80900023_20130629_114253_04_Vollumfang_getriggert_D0041813	W16	1
BAD-IP_26_80900023_20130629_114253_04_Vollumfang_getriggert_D0041813	W32	1
BAD-IP_26_80900023_20130629_114253_04_Vollumfang_getriggert_D0041813	W8	1
BAD-IP_26_80900023_20130629_114253_05_GPS_D0051813	DAT	6.851
BAD-IP_26_80900023_20130629_114253_05_GPS_D0051813	R32	43.541
BAD-IP_26_80900023_20130629_114253_05_GPS_D0051813	T64	12.441
BAD-IP_26_80900023_20130629_114253_05_GPS_D0051813	W16	18.661
BAD-IP_26_80900023_20130629_114253_05_GPS_D0051813	W32	6.221
BAD-IP_26_80900023_20130629_114253_06_Bordnetz_D0061813	DAT	10.561
BAD-IP_26_80900023_20130629_114253_06_Bordnetz_D0061813	I16	47.601
BAD-IP_26_80900023_20130629_114253_06_Bordnetz_D0061813	T64	31.731
BAD-IP_26_80900023_20130629_114253_06_Bordnetz_D0061813	W32	63.471
BAD-IP_26_80900023_20130629_114253_06_Bordnetz_D0061813	W8	119.011
BAD-IP_26_80900023_20130629_114253_07_IPEspeed_komplett_D0071813	DAT	21.581
BAD-IP_26_80900023_20130629_114253_07_IPEspeed_komplett_D0071813	R32	1.702.271
BAD-IP_26_80900023_20130629_114253_07_IPEspeed_komplett_D0071813	T64	141.851
BAD-IP_26_80900023_20130629_114253_07_IPEspeed_komplett_D0071813	W16	106.391
BAD-IP_26_80900023_20130629_114253_07_IPEspeed_komplett_D0071813	W32	70.921
BAD-IP_26_80900023_20130629_114253_07_IPEspeed_komplett_D0071813	W8	425.561
BAD-IP_26_80900023_20130629_114253_08_Temperaturen_Motorraum_D0081813	DAT	6.931
BAD-IP_26_80900023_20130629_114253_08_Temperaturen_Motorraum_D0081813	I16	94.331
BAD-IP_26_80900023_20130629_114253_08_Temperaturen_Motorraum_D0081813	T64	47.161
BAD-IP_26_80900023_20130629_114253_08_Temperaturen_Motorraum_D0081813	W32	23.591
BAD-IP_26_80900023_20130629_114253_08_Temperaturen_Motorraum_D0081813	W8	17.681
BAD-IP_26_80900023_20130629_114253_09_Ereignisgesteuert_TS010001813	DAT	2.021
BAD-IP_26_80900023_20130629_114253_09_Ereignisgesteuert_TS010001813	R32	70.361
BAD-IP_26_80900023_20130629_114253_09_Ereignisgesteuert_TS010001813	W64	140.721
BAD-IP_26_80900023_20130629_114253_09_Ereignisgesteuert_TS010011813	DAT	2.021
BAD-IP_26_80900023_20130629_114253_09_Ereignisgesteuert_TS010011813	R32	70.341
BAD-IP_26_80900023_20130629_114253_09_Ereignisgesteuert_TS010011813	W64	140.691
BAD-IP_26_80900023_20130629_114253_09_Ereignisgesteuert_TS010021813	DAT	2.021
BAD-IP_26_80900023_20130629_114253_09_Ereignisgesteuert_TS010021813	R32	72.191
BAD-IP_26_80900023_20130629_114253_09_Ereignisgesteuert_TS010021813	W64	144.391

## Conclusions

- ▶ Each message that is recorded event-controlled receives an individual time channel
- ▶ In DAT format of the logger measurement each message creates an own internal storage group (TSxxxxxx.DAT)
- ▶ In order to ensure strong system performance, it is useful to check the number of event-controlled measuring signals according to the application (necessary number of storage groups).

## Measurement data set

In table view, it becomes obvious that time intervals are not equidistant any more and messages (signals) are no more identical. Each value is measured and saved at the time it actually occurs on the CAN bus.

Index	Time BAD-IP_26_8090...	Speed_mph_3 BAD-IP_26_80900023_...	Time BAD-IP_26_80...	Speed_mph_2 BAD-IP_26_809000...	Time BAD-IP_26_8...	Speed_mph_1 BAD-IP_26_809000...
4934	240,898994	2,53171491622925	246,98334	2,76187086105347	247,638911	2,41663670539856
4935	240,97946	2,53171491622925	247,033392	2,76187086105347	247,688266	2,41663670539856
4936	240,999118	2,53171491622925	247,084021	2,76187086105347	247,738998	2,53171491622925
4937	241,079566	2,41663670539856	247,123429	2,76187086105347	247,788547	2,76187086105347
4938	241,098938	2,41663670539856	247,173719	2,64679265022278	247,848182	2,76187086105347
4939	241,179301	2,41663670539856	247,223519	2,64679265022278	247,88858	2,53171491622925
4940	241,260063	2,30155897140503	247,273564	2,64679265022278	247,948201	2,18648099899292
4941	241,289621	2,30155897140503	247,323497	2,64679265022278	247,998492	2,18648099899292
4942	241,318031	2,30155897140503	247,373686	2,64679265022278	248,058398	2,18648099899292
4943	241,389505	2,30155897140503	247,423454	2,64679265022278	248,088545	2,41663670539856
4944	241,41812	2,30155897140503	247,473635	2,64679265022278	248,148236	2,53171491622925
4945	241,489817	2,18648099899292	247,52342	2,64679265022278	248,188478	2,30155897140503
4946	241,508455	2,18648099899292	247,573539	2,53171491622925	248,248249	2,18648099899292
4947	241,579502	2,18648099899292	247,62349	2,53171491622925	248,288752	2,30155897140503
4948	241,608423	2,18648099899292	247,67366	2,53171491622925	248,348459	2,41663670539856
4949	241,679551	2,18648099899292	247,723447	2,53171491622925	248,388811	2,41663670539856
4950	241,708274	2,07140302658081	247,773624	2,53171491622925	248,448397	2,41663670539856
4951	241,779567	2,07140302658081	247,823407	2,53171491622925	248,48874	2,53171491622925
4952	241,808086	2,07140302658081	247,873659	2,53171491622925	248,548416	2,64679265022278
4953	241,879497	2,07140302658081	247,923452	2,41663670539856	248,588424	2,87694883346558
4954	241,908284	2,07140302658081	247,973633	2,41663670539856	248,638883	3,10710477828979
4955	241,979364	2,07140302658081	248,033872	2,41663670539856	248,688384	3,45233845710754

### 7.8.5 Practical example: Determination of the latency of two signals

#### Task

An electronic system (ECU) receives messages via CAN bus (input signals) and sends them out again on the CAN bus, e.g. as forwarding or after calculation (output signals).

Processing time = response time of the system is to be determined.

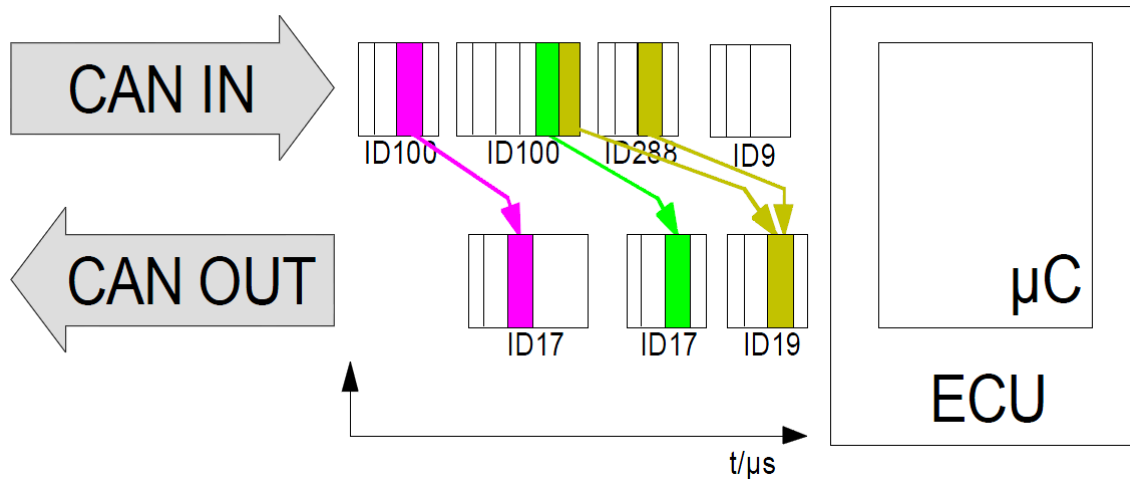

#### Realization

The response time results from the time difference between input and respective output signal. Since both incoming and outgoing CAN messages are provided with a time stamp, the exact time difference can be determined through event-controlled measurement.

Advantages:

- ▶ No event gets lost (not fixed to a sampling rate or to several signals within one sampling interval).
- ▶ Unique time stamps from TESTdrive are used.
- ▶ Event-controlled measurement is based on traffic measurement > traffic group.
- ▶ Each ID generates an event with a new signal value.



## 7.9 Data storage

### Quick start recording

Depending on the traffic group settings, the Quick start feature records measurement data during the logger boot-up and between two consecutive acquisitions (previous acquisition is stopped but the following acquisition is not yet started). The modified function is now providing 3 options:

- **Off** No Quick start recording
- **ON** Quick start recording during boot-up and between measurements
- **Only at start** Quick start recording during boot-up only

The second option (**Quick start ON**) corresponds to the formerly behavior. Selecting **Only at start** will record data only during boot-up, not between stop and restart of an acquisition.

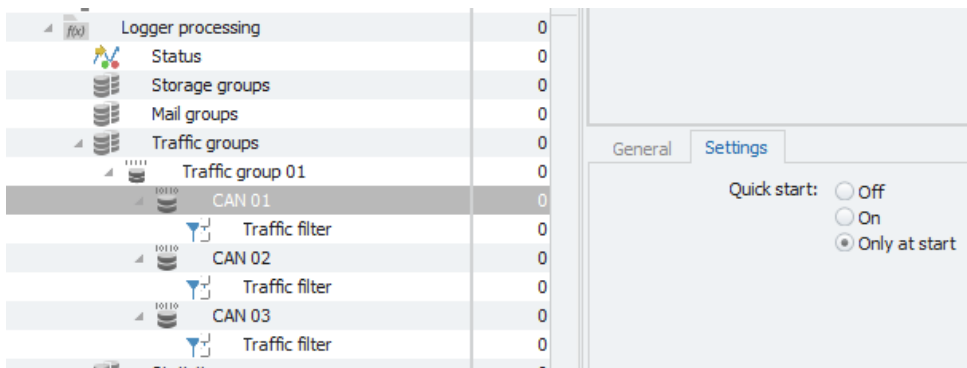

### Post processing delay times

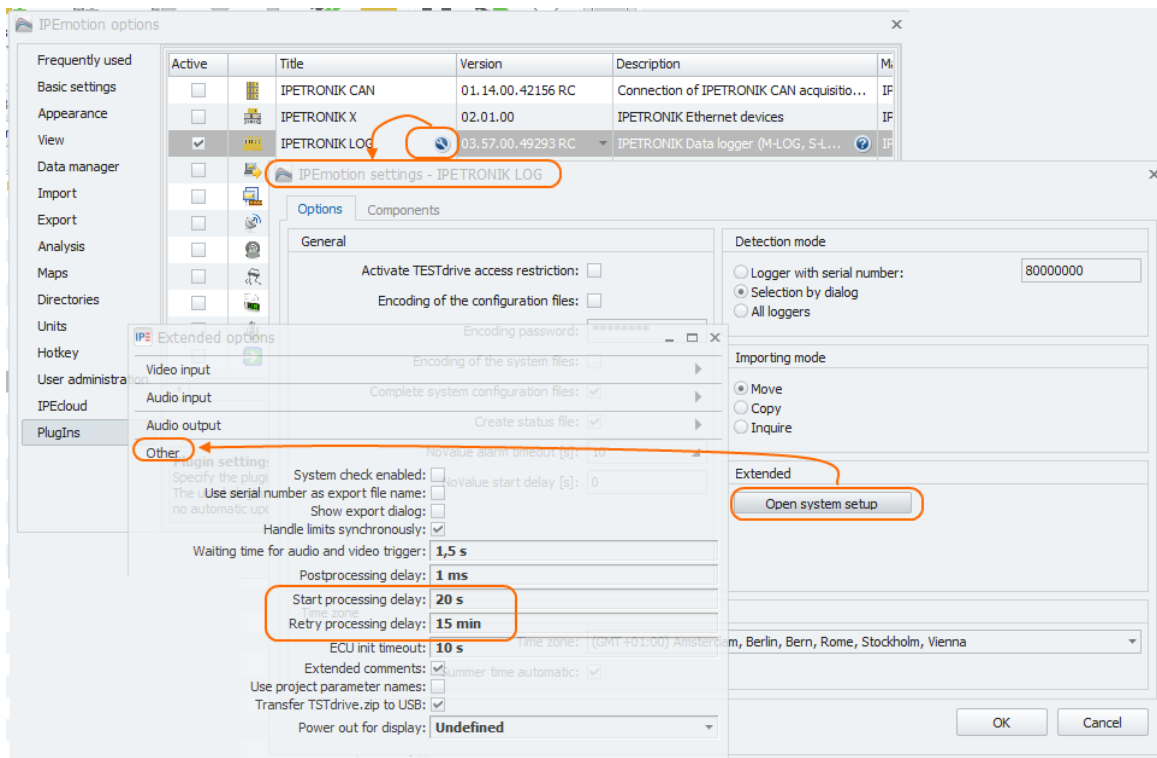

If the Postprocessing has been activated, two specific option can be defined.

- ▶ **Start Delay**     The postprocessing starts with a delay of x seconds past to measurement start. Value has to entered in seconds. Default setting = 20 s. Valid range: 10 s – 5 min.
- ▶ **Retry Delay**     Restart of the data transfer in case of the unsuccessful attempt (sample cause: FTP server unavailable, insufficient data rate, ...): Value has to entered in seconds. Default setting = 900 s. Valid range: 30 s – 30 min.

To modify the current settings, enter the extended systems settings under

**Options > Plugins > Plugin IPETRONIK-LOG > Options > Open system setup**

## 7.10 Data transfer & communication

### WLAN status information

TESTdrive cyclically executes a WiFi SSID scan every 30 seconds in order to report all available WLAN networks and networks that are no longer accessible. The report only contains changes related to the previous scan. The log output of new connections is listed with SSID, alle channels and the signal strength (RSSI in dBm). Connections that are no longer available are listed with the SSID only. The WiFi scan feature is supported exclusively by data loggers with built-in WiFi device (no support for M-LOG/M-LOG V3 with COMgate/COMgate V3).

#### Sample of a log output:

##### New contact to WLAN network(s) :

```
SSID           Channel(s) (RSSI [dBm])
IPE-TESTING    ; 1 (-100); 5 (-65); 11 (-71);
Hotspot_Xdtfr  ; 1 (-98); 5 (-65); 11 (-71);
Testbench_PT25432 ; 11 (-69);
```

##### Lost contact to WLAN network(s):

```
SSID: IPEhub2_03561
SSID: Testbench_PT25377
SSID: Hotspot_Xdtfr
```

### Category overview

Storage, traffic and statistic groups now provide the new tab **Categories**. Select a group and assign it to one or multiple transfer categories. The overview dialog shows all selected groups in the respective category.

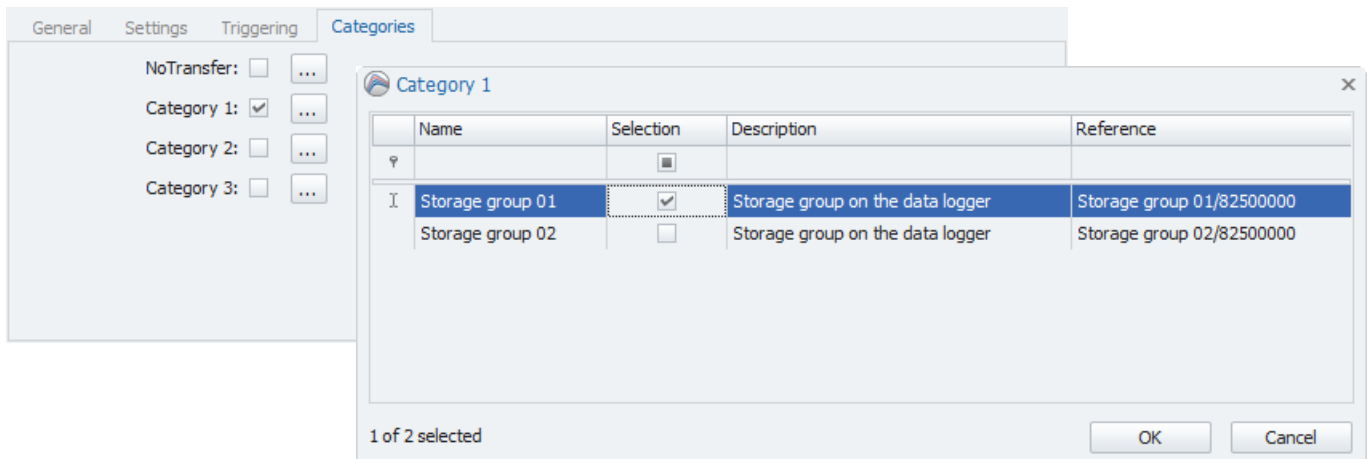

## 8 Options (license required)

### 8.1 Hardware options (internal)

M-LOG and S-LOG can be extended by 3 slots with different IPETRONIK cards. Max. 3 cards can be combined depending on the assignment to the extension slots and the port replicator. The active CAN cards support a highly accurate 1  $\mu$ s time stamp. This time stamp is synchronous for all inputs within a card.

#### 8.1.1 CAN cards

The following CAN cards with galvanically isolated high speed inputs acc. to ISO 11898-2 and low speed acc. to ISO 11992-1 are available:

- ▶ 2 x CAN High Speed, WakeOnCAN functionality, active data preprocessing and message buffer
- ▶ 4 x CAN High Speed, WakeOnCAN functionality, active data preprocessing and message buffer
- ▶ 3 x CAN High Speed, WakeOnCAN functionality, active data preprocessing and message buffer + 1 x CAN Low Speed (5 V, fault-olerant)
- ▶ 3 x CAN High Speed, WakeOnCAN functionality, active data preprocessing and message buffer + 1 x CAN Low Speed (24 V)

#### 8.1.2 CAN / LIN cards

The following CAN LIN combination cards with galvanically isolated inputs are available:

- ▶ 2 x CAN High Speed, WakeOnCAN functionality, active data preprocessing and message buffer + 2 x LIN
- ▶ 2 x CAN Single Wire (GMW 3089 V2.1) + 2 x LIN
- ▶ 1 x CAN Single Wire (GMW 3089 V2.1) + 1 x CAN High Speed, WakeOnCAN functionality, active data preprocessing and message buffer + 2 x LIN

#### 8.1.3 Ethernet cards

The following ETH card with galvanically isolated inputs is available:

- ▶ 2 x ETH 10/100 MBit LAN, e.g. as input via XCPonEthernet or FlexRay-Ethernet converter

## 8.2 Software options

### 8.2.1 Import signal description files

IPEmotion supports the import and management of signal descriptions from CANdb (\*.dbc), ASAP2 files (\*.a2l), and diagnostic description files (\*.idf).

The contents are read and managed by importing the original files into a database (Microsoft SQL-Server). The original files are therefore not longer required. Please note at updating the CAN system or the control unit that the current description file must be reloaded to update signal descriptions, if required. An export of the signal settings changed with IPEmotion into the original description file is not possible.

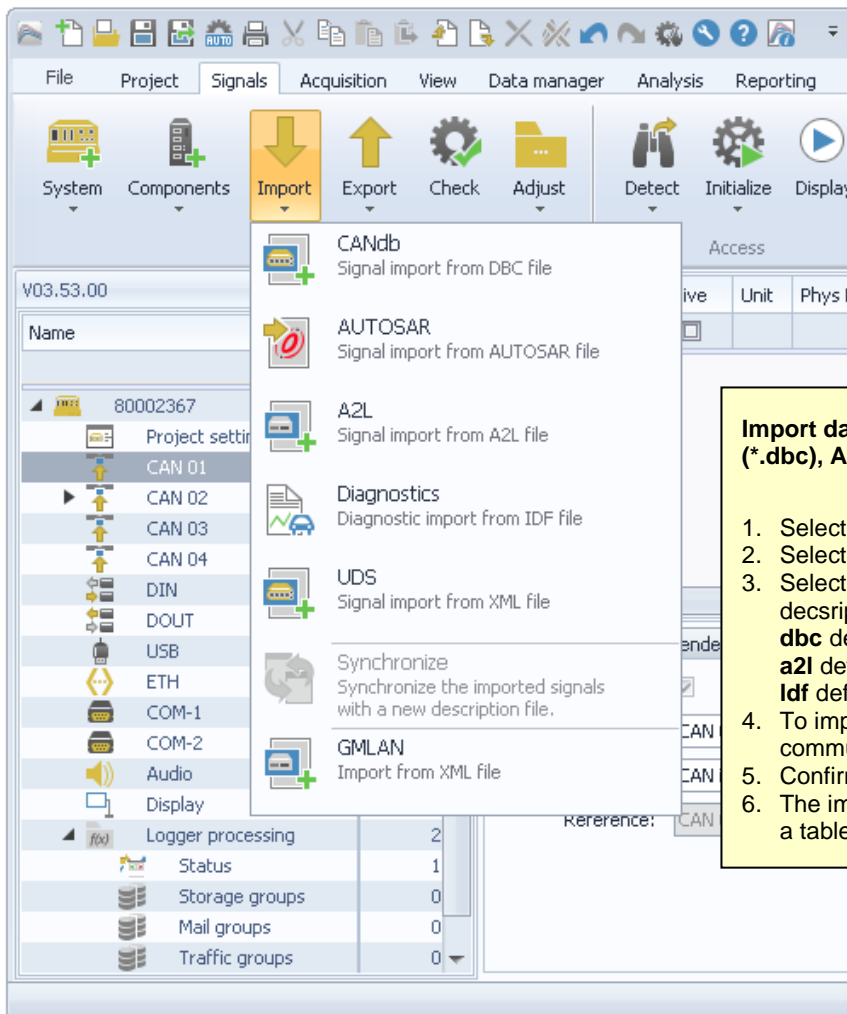

#### Import data from a description file: CANdb (\*.dbc), ASAP2 (.a2l), LINdb (\*.ldf)

1. Select a CAN input (here CAN 01).
2. Select **Import** from the tool bar.
3. Select the directory and the type of the description file to open.  
**dbc** defines CANdb files  
**a2l** defines ASAP2 files  
**ldf** defines LINdb files (LIN Description File)
4. To import an A2L file, select the communication protocol first
5. Confirm with OK.
6. The imported signals (Pool) are displayed in a table.



*General signals at CAN 01 cannot be configured if CAN 01 is already used for IPETRONIK devices!*

*Importing signal descriptions from ASAP2 or CANdb is the easiest and most secure method to configure signals.*

*Signals can also be manually created at an input (without description file). Select **Add components > Standard CAN** from the tool bar within the **Signals** navigation tab.*

## Import CANdb file

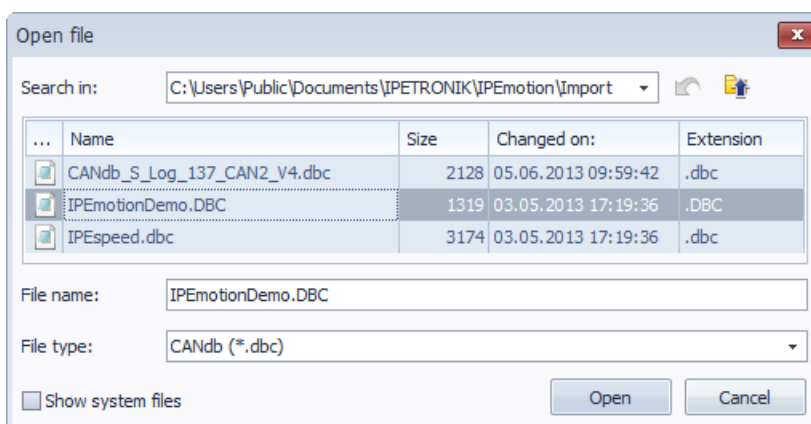
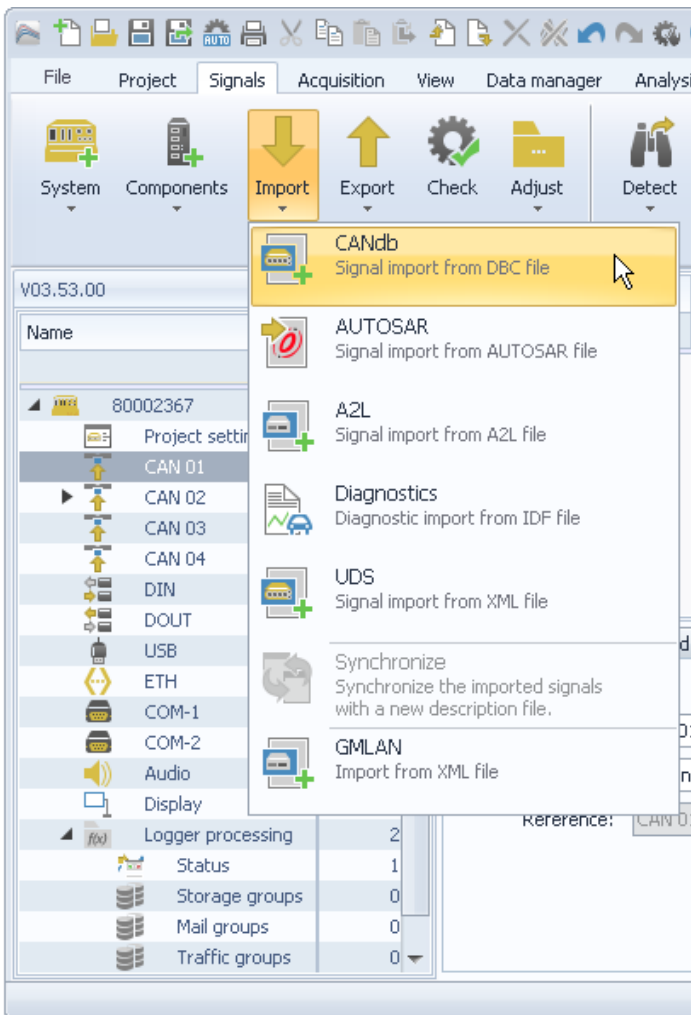

### Import signal descriptions from the CANdb

**Signals in data source**      **Select signal**      **Properties of highlighted signal (Front\_right)**

The screenshot shows the 'CANdb import: CAN 01' dialog box. It features a table of signals with columns for Name, Selection, Sampling rate, Physical range, and Description. The 'Front\_right' signal is highlighted, and its properties are shown in a panel on the right. The 'Importer' section at the bottom provides instructions on how to use the dialog.

Name	Selection	Sampling rate	Physical range	Description
Pressure_Abs	<input checked="" type="checkbox"/>	1 Hz	0 bar ... 2 bar	
Pressure_Rel	<input checked="" type="checkbox"/>	1 Hz	-2 bar ... +2 bar	
MAP	<input checked="" type="checkbox"/>	1 Hz	0 bar ... 3 bar	
TPS_Volt	<input checked="" type="checkbox"/>	1 Hz	-8 V ... +8 V	
Front_left	<input type="checkbox"/>	1 Hz	-50 C ... +200 C	
Front_right	<input type="checkbox"/>	1 Hz	-50 C ... +200 C	
Rear_left	<input type="checkbox"/>	1 Hz	-50 C ... +200 C	
Read_right	<input type="checkbox"/>	1 Hz	-50 C ... +200 C	
Exhaust_1	<input type="checkbox"/>	1 Hz	-50 C ... +1200 C	
Exhaust_2	<input type="checkbox"/>	1 Hz	-50 C ... +1200 C	

**Project**

- Project num
- Project versio

**Protocol: FreeRunning**

- Protocol: FreeRunning
- Signal count: 10
- CAN baudrat: 0 Bd
- J1939:

**Message**

- Name: SIM\_51499999...
- CAN ID: a h
- Length: 8
- Sampling rate: 1 Hz
- Description:

**Signal**

- Name: TPS\_Volt
- Display identi
- Byte order: INTEL
- Data type: 16-Bit integer u...
- Bit count: 16
- Start bit: 48
- Bit mask: ffff h
- Physical min: -8
- Physical maxi: 8
- Unit: V
- Factor: 0,000244144
- Offset: -8
- CAN ID: a h

**Importer**

In this dialog, all signals that can be imported from the description file are displayed. In the left table, all signals, where the "selection" checkboxes are selected, will be marked for import. In the right table the properties of the selected signals, the control unit and the protocol are displayed. Depending on the protocol, a sampling rate or the DAQ list to use, can be assigned to the signals. In the case of a protocol using DAQ lists (CCP, XCP), you can specify via the column selection dialog, if the signals are configured by the sampling rate or a DAQ list. To achieve this you should open the column selection dialog, via the context menu of the table header, and then drag the desired column ("sampling" or "DAQ list") from the column selection dialog to the table header. The other column is removed automatically. If in a protocol based on DAQ lists, sampling rates are used for the signal configuration, during import the signals are assigned to the available DAQ list with the most suitable sampling rate.

Select all      IPEmotionDemo.DBC - 4 of 10 signals selected.      OK      Cancel

## Import ASAP file

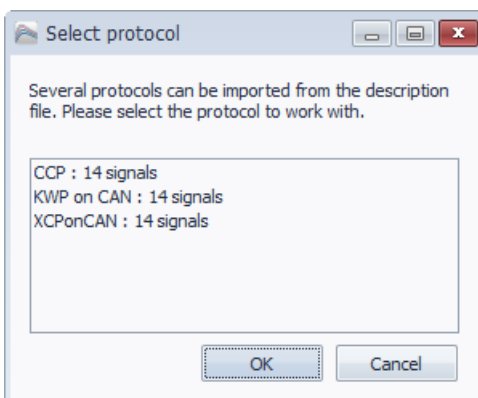
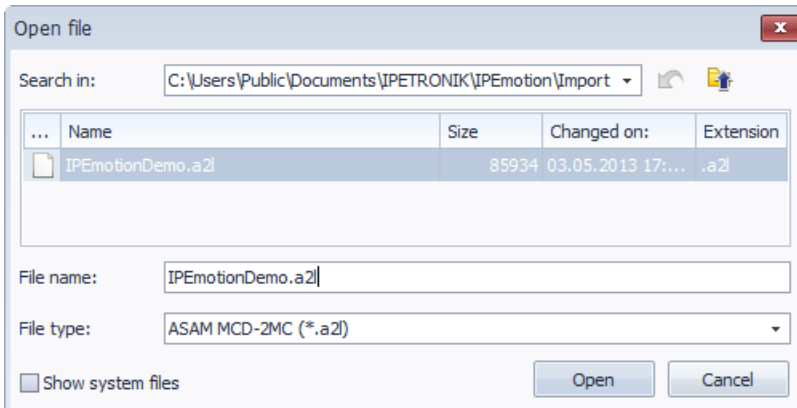

### Import signal descriptions from A2L

Signals in data source

Select signal

Properties of highlighted signal (Front\_right)

Name	Selection	Sampling rate	Physical range	Description
Voltage_1	<input checked="" type="checkbox"/>	1 Hz	0 V ... 996 mV	Test voltage 1
Voltage_2	<input checked="" type="checkbox"/>	1 Hz	0 V ... 996 mV	Test voltage 2
Voltage_3	<input checked="" type="checkbox"/>	1 Hz	-10 V ... +9,999 V	Test voltage 3
Temp_1	<input checked="" type="checkbox"/>	1 Hz	0 °C ... 255,996 °C	Temp measuring value 1
Temp_2	<input checked="" type="checkbox"/>	1 Hz	-60 °C ... +1370 °C	Temp measuring value 2
Temp_3	<input checked="" type="checkbox"/>	1 Hz	-20 °C ... +107,998 °C	Temp measuring value 3
Meaval_1	<input type="checkbox"/>	1 Hz	0 m/s <sup>2</sup> ... 127,5 m/s <sup>2</sup>	Sample measuring value 1
Meaval_2	<input type="checkbox"/>	1 Hz	0 m/s <sup>2</sup> ... 100 m/s <sup>2</sup>	Sample measuring value 2
Meaval_3	<input type="checkbox"/>	1 Hz	0 m/s <sup>2</sup> ... 127,5 m/s <sup>2</sup>	Sample measuring value 3
Meaval_4	<input type="checkbox"/>	1 Hz	0 m/s <sup>2</sup> ... 100 m/s <sup>2</sup>	Sample measuring value 4
Meaval_5	<input type="checkbox"/>	1 Hz	0 m/s <sup>2</sup> ... 127,5 m/s <sup>2</sup>	Sample measuring value 5
U_Batt	<input type="checkbox"/>	1 Hz	0 V ... 25,5 V	Battery voltage
BatTemp	<input type="checkbox"/>	1 Hz	-20 °C ... +107 °C	Battery temp
StrgTemp	<input type="checkbox"/>	1 Hz	-20 °C ... +107 °C	ECU temp

**Importer**  
 In this dialog, all signals that can be imported from the description file are displayed.  
 In the left table, all signals, where the "selection" checkboxes are selected, will be marked for import.  
 In the right table the properties of the selected signals, the control unit and the protocol are displayed.  
 Depending on the protocol, a sampling rate or the DAQ list to use, can be assigned to the signals. In the case of a protocol using DAQ lists (CCP, XCP), you can specify via the column selection dialog, if the signals are configured by the sampling rate or a DAQ list. To achieve this you should open the column selection dialog, via the context menu of the table header, and then drag the desired column ("sampling" or "DAQ list") from the column selection dialog to the table header. The other column is removed automatically.

### CCP protocol settings

**Resume active**  
 The ECU can be disconnected and and reconnected to the CAN bus. Data acquisition is continued after reinitialization.

**Seed & Key**  
 Authentication procedure used for restricted access to ECUs. A program file provided by the ECU manufacturer is required to proof access authority.

**EPK check**  
 Compares the checksums of the configuration (A2L file) with the respective sums stored with the ECU.

**Use optional commands**  
 Enables optional commands provided by the ECU. Commands are listed in the A2L file and make the communication more comfortable.





You need to copy the Seed&Key file which relates to the ECU to one of the these subdirectories. If the file is missing the authentication procedure fails.

C:\Users\Public\Documents\IPETRONIK\IPEmotion\Import  
C:\Users\Public\Documents\IPETRONIK\IPEmotion\Custom\SeedAndKey

### Import PDX file

In order to align the version of the A2L file with the contents stored in the ECU, several PDX files can be imported at a single CAN knot. Each ECU requires its corresponding PDX file.

The PDX file contains all necessary information to request program and data version from the ECU. After the import of this information, the logger reads the corresponding data from the ECU using the UDS protocol. A matching algorithm compares the contents of the relating \*.a2l file with the data read from the ECU.

Depending on the result of the comparison, measurement will be resumed, stopped totally or partial, e.g. with protocol measurements with a CAN, FlexRay or Ethernet ECU.

Program an data version information imported from the ECU will be stored in the log file and the measurement status file. Tasks that require a Java script are not implemented.

Supported physical connection are: Diagnostic CAN, OBD2 connector, standard CAN tapping point.

### Import properties – DAQ list fill level (numerical, graphical)

Highlight the respective DAQ list (e.g. 100 ms sync event channel) and right click with the mouse to open the context menu, select **Import properties**.

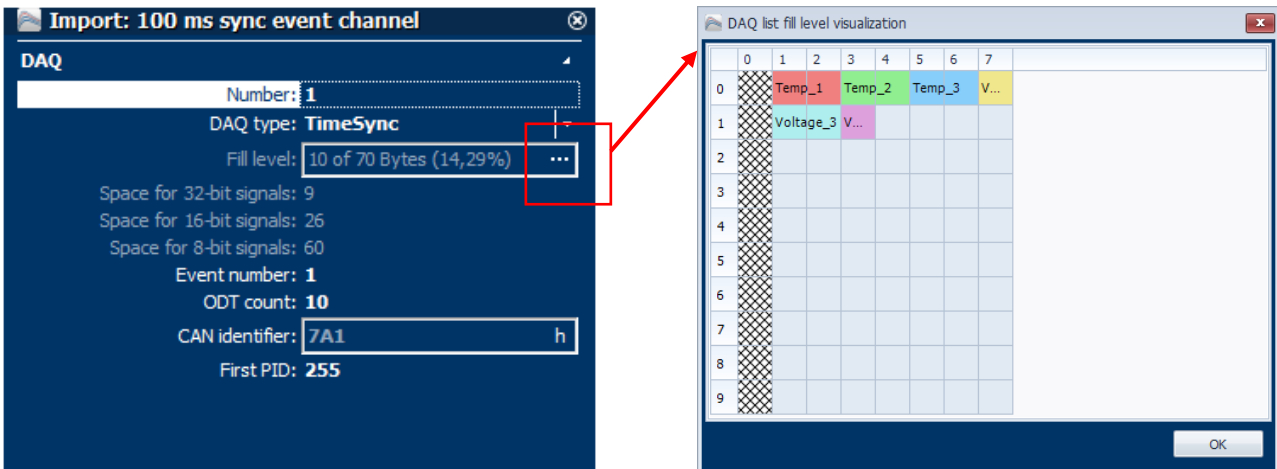

## Import Diagnostic file

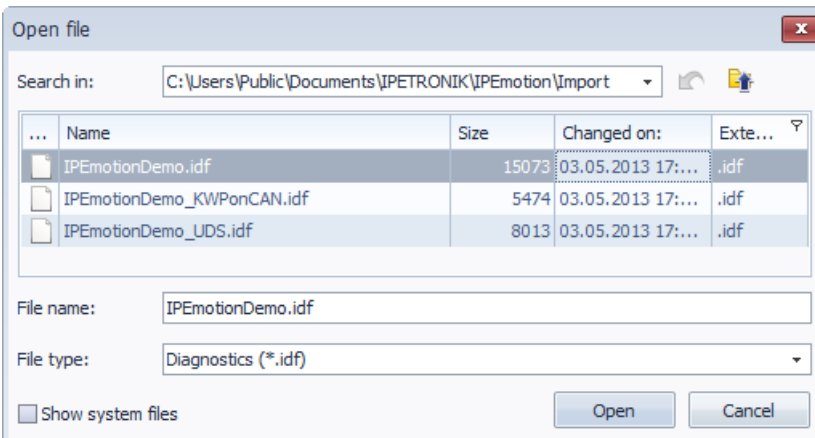
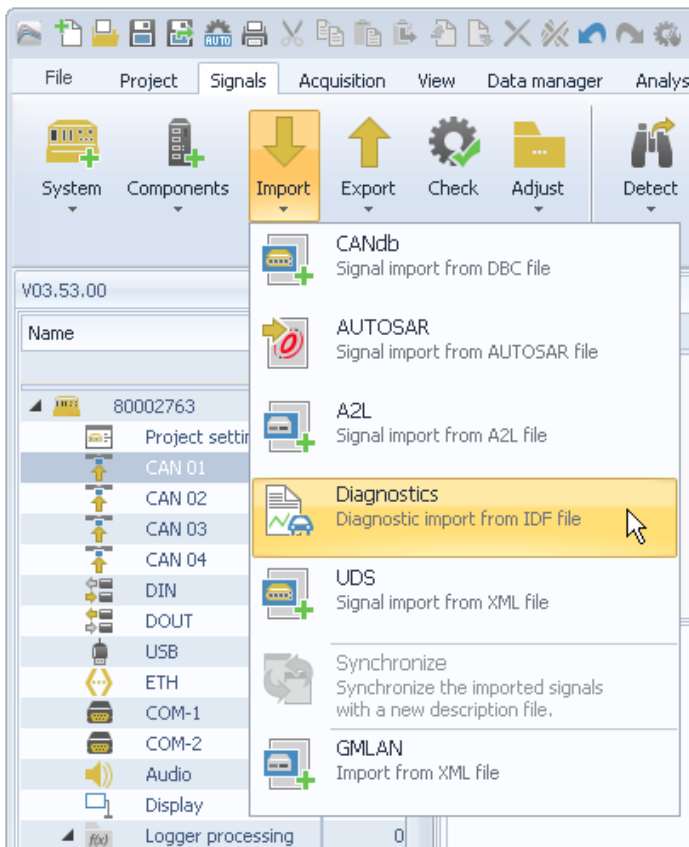

## Description file synchronizing

The synchronization feature provides the possibility to compare existing signal descriptions (imported previously) with the respective entries of a modified description file.

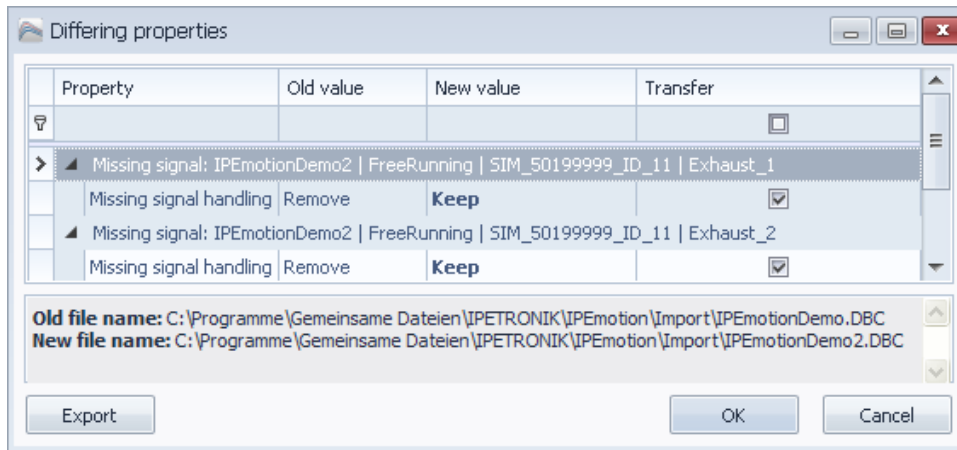

### Possibility 1: Channels within a description file have been modified

Previously a description file has been imported and signals have been assigned to the CAN measuring input. Now, a new description file containing modified scaling settings of several signals should be used.

Highlight the description file at the CAN input in the left hand system structure and select **Import > Synchronize** from the main menu or from the context menu. Search for the modified description file on your computer and confirm your selection with **OK**. The new settings will be used for the current configuration.

### Possibility 2: Channels have been added to a description file

Previously a description file has been imported and signals have been assigned to the CAN measuring input. Now, a new description file containing additional channel settings (signals have been added) should be used.

Highlight the description file at the CAN input in the left hand system structure and select **Import > Synchronize** from the main menu or from the context menu. Search for the modified description file on your computer and confirm your selection with **OK**. The CAN input will be synchronized with the new settings. Even if you open the import module again, new channels will be displayed in the left hand area. Select the channels to import the related settings into the current configuration.

## 8.2.2 Detection mode and cycle rate

### Polling

Polling functionality is supported by A2L for CCP and XCP, i.e. no DAQ lists are required.

Polling
10 ms sync event channel
100 ms sync event channel
seg sync event channel

IPEmotion offers three different speeds for data requests. The times are reference values because the values must be individually requested at the control unit and create a high bus load.

SLOW            1000 ms            MIDDLE            100 ms            FAST            10 ms

Example: If 5 values are detected in the SLOW polling mode, the 1<sup>st</sup> value is requested by the control unit a 2<sup>nd</sup> time after approx. 6 s.



#### DAQ list or polling?

Communication via CCP protocol takes place by sending the data cyclically or triggered by an event after the first inquiry. The send rate is defined in the respective DAQ list, e.g. 10 ms, 100 ms or synchronous to an event. Not all control units support this mode or the DAQ lists are not included in the A2L file. In this case, the signals can be sampled individually with the polling mode. But this method causes a much higher bus load and therefore longer response times.

## 8.2.3 Traffic acquisition

The CAN traffic acquisition (also CAN-Trace) allows high-capacitive recording of CAN and/or LIN messages (total bus traffic) with the CAN/LIN controller of each measuring input. Due to the fact that a huge amount of data can result from this method within a short time, data acquisition can be restricted with definable ID triggers (measuring input) and admission filters (traffic group).

Using the tab **Triggering** a trigger condition can be defined for each traffic group to control data recording individually.

### Filters and triggers

The **Traffic id trigger** at the respective CAN input of the system structure provides 6 individual ID triggers. As soon as at least one of the trigger conditions is fulfilled, traffic recording is started (logical OR function). Without any Traffic id trigger, traffic recording is started immediately after measurement start. Each id trigger can consist of a single identifier or an identifier range (First/Last CAN ID). Within the trigger definition, each of 8 bytes from the CAN message can be compared with a reference (supported operators: =, <, >, <=, >=, < >). Only if all conditions defined by the tab ID-Trigger are fulfilled, the respective ID-Trigger becomes active (logical AND function).

Status channels of Traffic id triggers can be used in calculations, e.g. only if a specific id trigger indicates status 1, traffic recording is started. Without any use of the **Traffic trigger status**, activate the checkbox **Trigger direct** under the tab **ID-Trigger** to start the traffic acquisition properly.

### Data format and conversion

Traffic data is saved in a binary file with header (description) and the actual data, e.g. TD001234.bin. To generally use the data (e.g. import in CANalyzer), data is converted into the ASCII format with the data converter.

Use the IPETRONIK data converter version 2.xx IPEconverter WIN with graphical user interface (requires a license ) or the version with the command line IPEconverter CMD (no license required).

The software, as well as, the documentation are saved at the IPETRONIK CD:

...\IPETRONIK\_SoftwareProducts\Tools\DataConverter\...

## Configuring traffic acquisition

1. Select a CAN input (CAN 02).
2. Select **Traffic recording** from the main menu **Components** or with the context menu and right mouse button.
3. Now the tree structure shows the new arm **Traffic recording** at the respective CAN input.
4. Select **Filter** and/or **ID-Trigger** from the main menu **Add components** or with the context menu and right mouse button to restrict the recording to the required data.

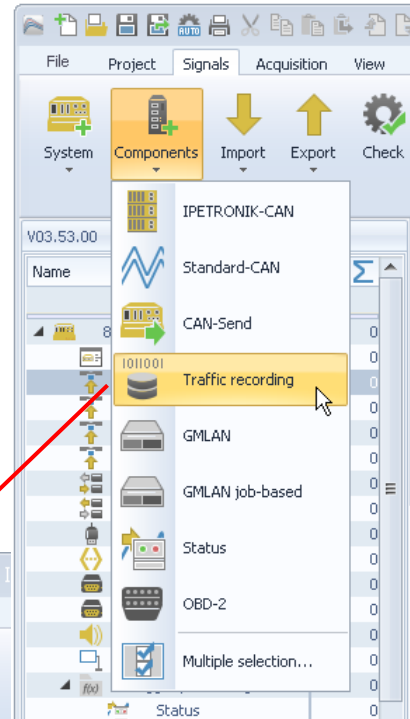

This screenshot shows the configuration window for traffic acquisition. The 'Traffic recording' component is selected under 'CAN 01'. The 'ID-Trigger' component is also selected. The configuration table below shows the settings for the ID-Trigger.

Name	Active	Description	First CAN ID [hex]	Last CAN ID [hex]	Operator for Byte 1	Value for Byte 1 [hex]	Data for Byte
> ID-Trigger 01	<input checked="" type="checkbox"/>	ID-Trigger	A	A	Off		0
ID-Trigger 02	<input type="checkbox"/>	ID-Trigger	A	A	Off		0
ID-Trigger 03	<input type="checkbox"/>	ID-Trigger	A	A	Off		0
ID-Trigger 04	<input type="checkbox"/>	ID-Trigger	A	A	Off		0
ID-Trigger 05	<input type="checkbox"/>	ID-Trigger	A	A	Off		0
ID-Trigger 06	<input type="checkbox"/>	ID-Trigger	A	A	Off		0

General	ID-Trigger
First CAN ID: A	Last CAN ID: A
Byte 1: Off	Byte 5: Off
Byte 2: Off	Byte 6: Off
Byte 3: Off	Byte 7: Off
Byte 4: Off	Byte 8: Off
Trigger direct: <input checked="" type="checkbox"/>	

## Creating a traffic group

1. Use Components to create a Traffic recording. You can add Traffic recording to any free CAN input.
2. Highlight **Traffic groups** from the left hand system structure
3. Select **Traffic group** from the main menu **Components** or with the context menu and right mouse.
4. If needed, create further traffic groups and activate all CAN inputs you want to record traffic data from. You may use traffic data from a single CAN input in different traffic groups but recorded dependent on different triggers.

The screenshot shows the IPETRONIK software interface with the 'Components' menu open. The 'Traffic group' option is highlighted. A context menu is also visible over the 'Traffic groups' folder in the system structure tree. A red arrow points from the context menu to the 'Traffic groups' folder. Below the tree view, a table lists the configuration for 'Traffic group 01'.

Name	Active	Description
CAN 01	<input checked="" type="checkbox"/>	Connector to
CAN 02	<input checked="" type="checkbox"/>	Connector to be saved
CAN 03	<input type="checkbox"/>	Connector to be saved

The 'General' tab of the configuration panel shows the following details:

- Active:
- Name: Traffic group 01
- Description: Traffic group on the data logger
- Reference: Traffic group 01/80002763

## Traffic group and ring buffer traffic group settings

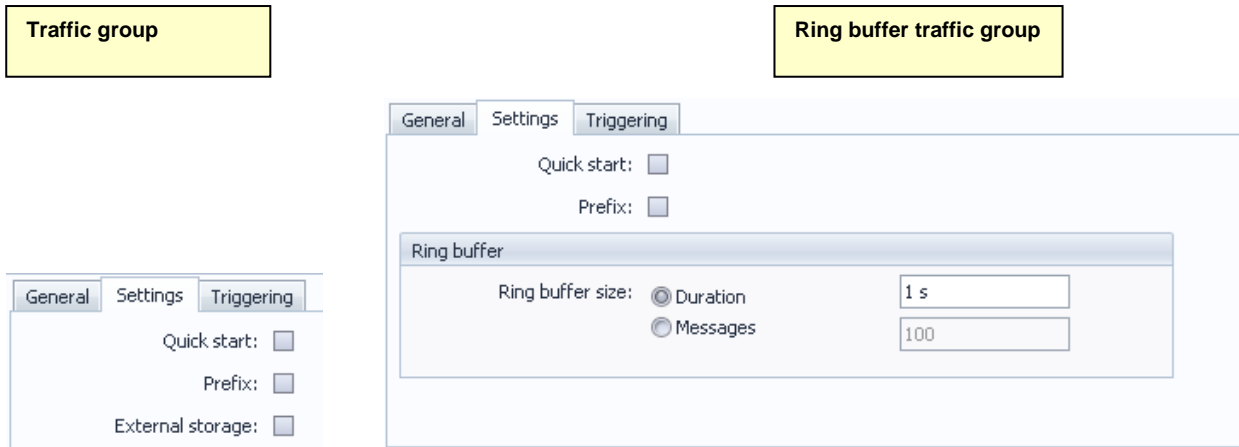

- Quick start** Quick start data (which is recorded during logger boot-up) is identified by a negative time stamp within the traffic data file.
- Prefix** The storage group name ist used for the measurement data file name.
- External storage** Data storage on external USB storage medium. Refer to [6.5 USB medium for external storage](#) for detailed information.
- Ring buffer size** Defines the size of the ring buffer for measuring. If the max ring buffer size is reached, the memory is overwritten beginning with the oldest data.

### Triggering

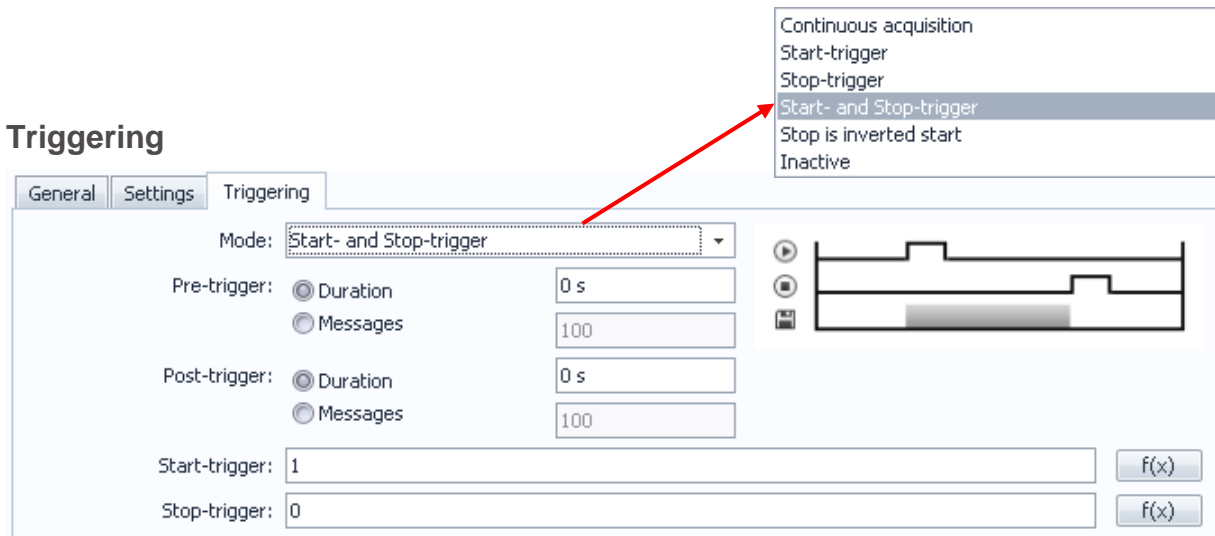

- Mode** Select the trigger mode (depending on the traffic group) from:  
 Continuous acquisition (no trigger), Stop is inverted start  
 Traffic group only:  
 Start-trigger, Stop-trigger, Start- and Stop-trigger (see [Triggering](#))
- Pre-trigger duration** Data recorded before the trigger event (duration = seconds or messages)
- Post-trigger duration** Data recorded after the trigger event (duration = seconds or messages)
- Start-trigger** Value, which starts the data storage of the respective group.
- Stop-trigger** Value, which stops the data storage of the respective group.



Using the Start-Stop condition, storage data will not be saved if the stop condition is already fulfilled at measurement start!

We recommend to define suitable events used for start- and stop-trigger. To guarantee acquisition start (data storage) in any case, you can set „1“ as start-trigger condition.



To evaluate quick start data in relation to cyclic data of a storage group, you have to activate **Time stamp channel** (for the absolute time) from the settings tab of the respective storage group.

## Filtering

User definable pass through filters enable the filtering of defined areas out of the data stream. This provides an ID filtering like: Traffic group 01 using ID 100[hex] while Traffic group 02 uses other filters or no filters.

The screenshot shows the IPeMotion software interface. The main window is titled 'IPeMotion' and has a menu bar with 'File', 'Project', 'Signals', 'Acquisition', 'View', 'Data manager', 'Analysis', 'Reporting', 'Scripting', and 'Info'. Below the menu bar is a toolbar with icons for 'System', 'Components', 'Import', 'Export', 'Check', 'Adjust', 'Detect', 'Initialize', 'Display', and 'Details'. The interface is divided into three main sections: Configuration, Access, and View.

The Configuration section on the left shows a tree view of the project structure. The 'Traffic recording' section is expanded, showing 'Traffic id trigger' and 'Status'. The 'Traffic groups' section is also expanded, showing 'Traffic group 01' and 'CAN 01'. The 'Traffic filter' is selected under 'CAN 01'.

The Access section in the middle shows a table of filters:

Name	Active	Description	First CAN ID [hex]	Last CAN ID [hex]
Filter 01	<input checked="" type="checkbox"/>	Admission filter for reducing the data volume	0	7F
Filter 02	<input checked="" type="checkbox"/>	Admission filter for reducing the data volume	0	7F
Filter 03	<input type="checkbox"/>	Admission filter for reducing the data volume	0	7F
Filter 04	<input type="checkbox"/>	Admission filter for reducing the data volume	0	7F
Filter 05	<input type="checkbox"/>	Admission filter for reducing the data volume	0	7F
Filter 06	<input type="checkbox"/>	Admission filter for reducing the data volume	0	7F
Filter 07	<input type="checkbox"/>	Admission filter for reducing the data volume	0	7F
Filter 08	<input type="checkbox"/>	Admission filter for reducing the data volume	0	7F
Filter 09	<input type="checkbox"/>	Admission filter for reducing the data volume	0	7F
Filter 10	<input type="checkbox"/>	Admission filter for reducing the data volume	0	7F
Filter 11	<input type="checkbox"/>	Admission filter for reducing the data volume	0	7F

The View section on the right shows the 'General' tab for the selected filter. It contains two input fields: 'First CAN ID' with the value '0' and 'Last CAN ID' with the value '7FF'. Both fields have a small 'h' icon next to them, indicating hexadecimal input.

The status bar at the bottom shows '1 of 1 selected' and 'PC: Control Panel - Energy options: Inactive'.



## 8.2.4 Statistics calculation

The frequency of signals is counted and evaluated with classifications. To do so, the acquisition range is divided into equal (equidistant) zones (classes). The current values is assigned to one class at every sampling and the frequency is counted (see figure).

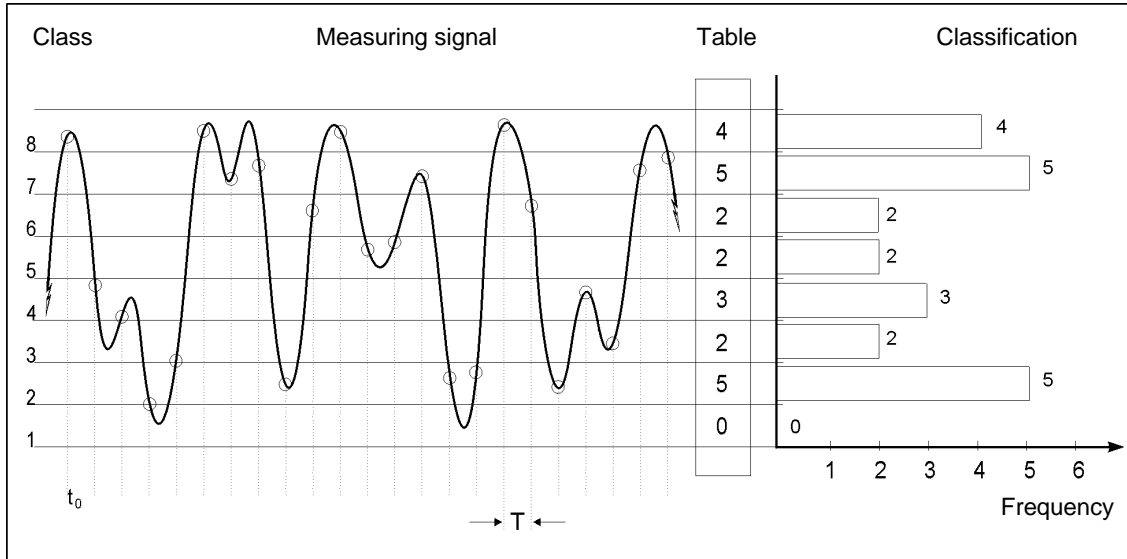

Advantages	Disadvantages
Much less storage required than with a time related acquisition	No original value
Very suitable for statistical analyses (e.g. life cycle tests)	No time reference of the signal

### Classification methods

Different classification methods have been developed in the past whereof IPETRONIK supports the most common methods (acc. to DIN 45667, FVA sheet):

- ▶ Random sampling counting
- ▶ Level crossing counting
- ▶ From-To counting
- ▶ Edge counting
- ▶ Rainflow method (available upon request)

Please find further information in the Classification.pdf document (Classifying with KIM/KAR and DIS) on the IPETRONIK CD or at the FTP info server.

### Requirements

**Hardware** M-LOG, S-LOG, FLEETlog, IPElog

**Configuration** IPEmotion

**Software** TESTdrive V03.06 or V03.18 (IPEmotion) or V03.50 (IPElog) or higher



*It is recommended to use the latest software version for guaranteeing a clean functionality of all components..*

## Configuring statistic / classification

### 1st Step Creating configuration

- ▶ Start IPEmotion and load an existing configuration or create a new configuration.
- ▶ Import the corresponding signal descriptions (CANdb or ASAP2) and/or configure additional IPETRONIK devices.
- ▶ Activate the desired inputs and run the required scaling.
- ▶ Select a sampling rate or accept the default sampling rate. Please note that the sampling rate, which is selectable in the classification, cannot be higher than the maximum sampling rate.

### 2nd Step Defining storage group (if time related data is also required)

- ▶ Create a new storage group with **Storage groups** and the context menu **Add components** to also record the time related signals.
- ▶ Assign the desired signals to the corresponding storage group.

### 3rd Step Defining classification

- ▶ Select **Data processing** in the system structure and select **Statistic** from the main menu **Add components** or with right mouse button > context menu.
- ▶ Select **Statistic** in the system structure and select **Components > Channel** from the main menu or with right mouse button > context menu to create channels.
- ▶ Define additional classification settings within the tabs **General**, **Settings**, and **Trigger**.

**Reset behaviour** Data is written into a new classification file at changing the configuration or at starting acquisition.

**Sampling rate** Data storage rate of classification

**Trigger (Statistik)** General trigger, defines start- and stop-trigger, value range 0 / 1

#### Classification

- Name** any name for classification
- Mode** selected classification method
- Trigger** defines start- and stop-trigger of the active channel (classification start and stop)

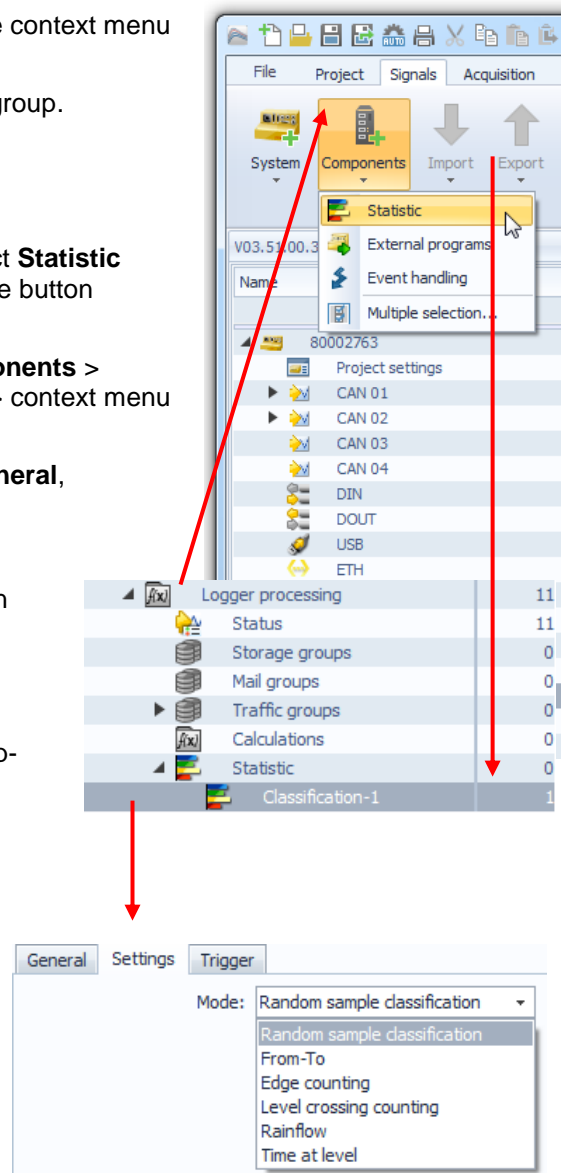

## 8.2.5 Operating in FTP mode (terminal server)

TESTdrive version 3.09.00 allows starting M-LOG as FTP server. Data can easily be transmitted with a FTP software (e.g. Total Commander or WS\_FTP). Depending on the user rights, data can additionally be deleted or written. A separate USB flash drive incl. TESTdriveCmd.xml file is required for this functionality. The running acquisition is stopped and the log file saved with connecting the USB.

If the TESTdriveCmd.xml file includes the "StartFTPServer" OnConnect job, there is no post processing. TESTdrive reads the corresponding parameters and starts the FTP server.

Server access requires the following user data:

Version	User	Password	Access rights
V03.09.00	guest	none	Read to TO directory

A reboot is automatically running at connecting USB flash drive to correctly stop the service as FTP server.

### Procedure:

1. Switch-on M-LOG
2. Connect USB flash drive with TESTdriveCmd.xml
3. Connect Ethernet cable between M-LOG and PC, e.g. 600-591.xxx (M-LOG PR05, S-LOG)
4. Configure network settings of PC, create additional "Alternative configuration"

User defined

IP address: 192.168.0.1 (Example)

Total Commander settings: Server name: 192.168.0.2, Enter user name and password

## 8.2.6 Recording audio and video data

### Recording video data

Data logger supports recording video or single shots with a camera. The camera is connected to the logger USB port.

Following settings are available:

Resolution	Defines the image quality	
"Low"	160 x 120 Pixel (B x H)	30/20/10/5 images per second
"Standard"	320 x 240 Pixel (B x H)	30/20/10/5 images per second
"High"	432 x 240 Pixel (B x H)	30/20/10/5 images per second
"Ultra"	640 x 480 Pixel (B x H)	30/20/10/5 images per second

Max. recording time Defines the recording duration

Frame rate Defines the number of images per second

All three options directly influence the required memory.

Trigger	A trigger condition must be defined to start recording.
Trigger mode	Triggering to raw data or scaled values
Raw	Triggering to raw data
Phys.	Triggering to physical values (acc. to scaling)

## Recording audio data

Data logger (M-LOG, S-LOG) supports recording audio signals (sounds, speech) with a microphone at the audio input.

Following settings are available:

Bit rate Defines the audio signal quality  
 22050 Bit/s (FM radio), 11025 Bit/s (AM radio), 8000 Bit/s (Phone quality)

Max. recording time Defines the recording duration

Both options directly influence the required memory.

Trigger A trigger condition must be defined to start recording.

Trigger mode Triggering to raw data (Raw) or scaled values (Phys)

## 8.2.7 OBD-2 measurement

With releases of the PlugIn IPETRONIK-LOG / TESTdrive ≥ V03.22 data acquisition using the OBD2 standard (CAN bus) supported.

The OBD-II international standard details a list of 96 predefined signals and measurement parameters which makes it easy to acquire provided operating data by a data acquisition system. This standard is mandatory for petrol engine cars since 2001 respective diesel engine cars since 2003 and trucks since 2005.

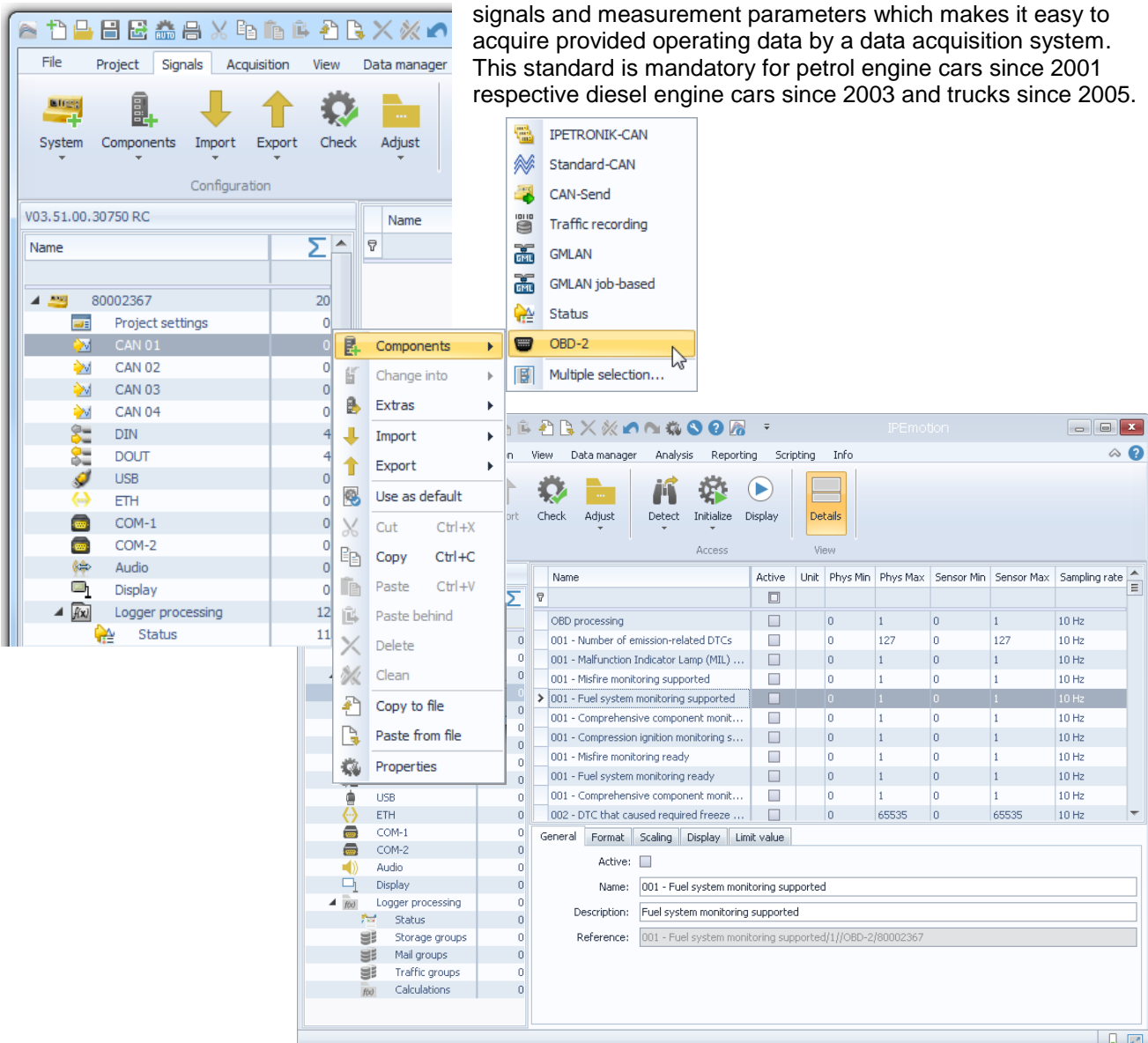

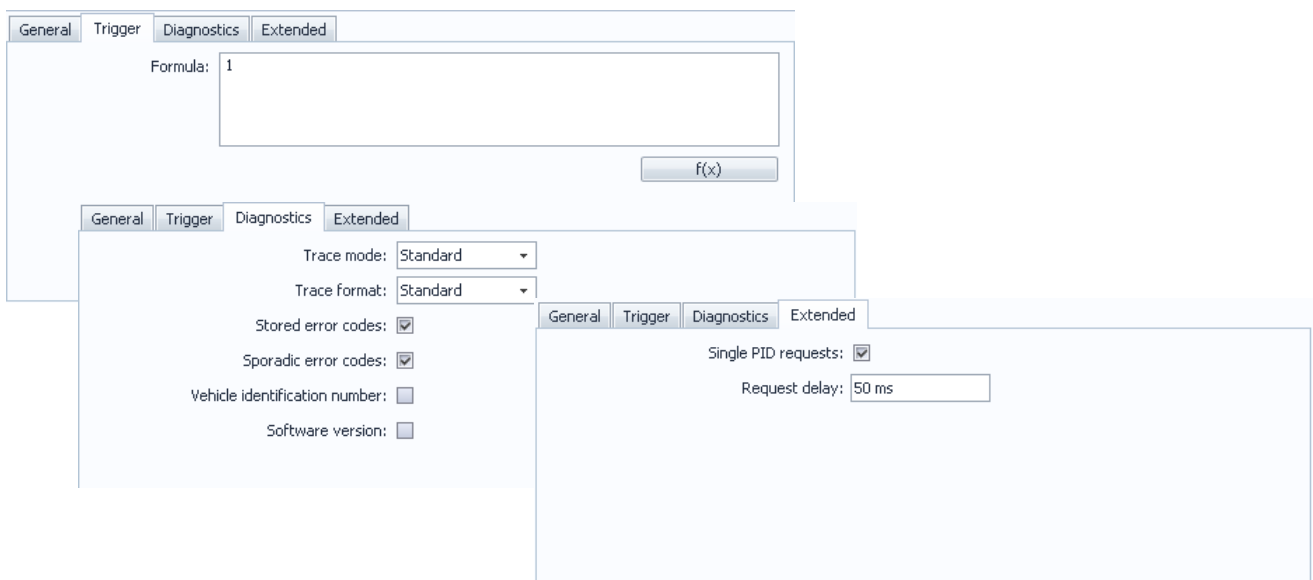
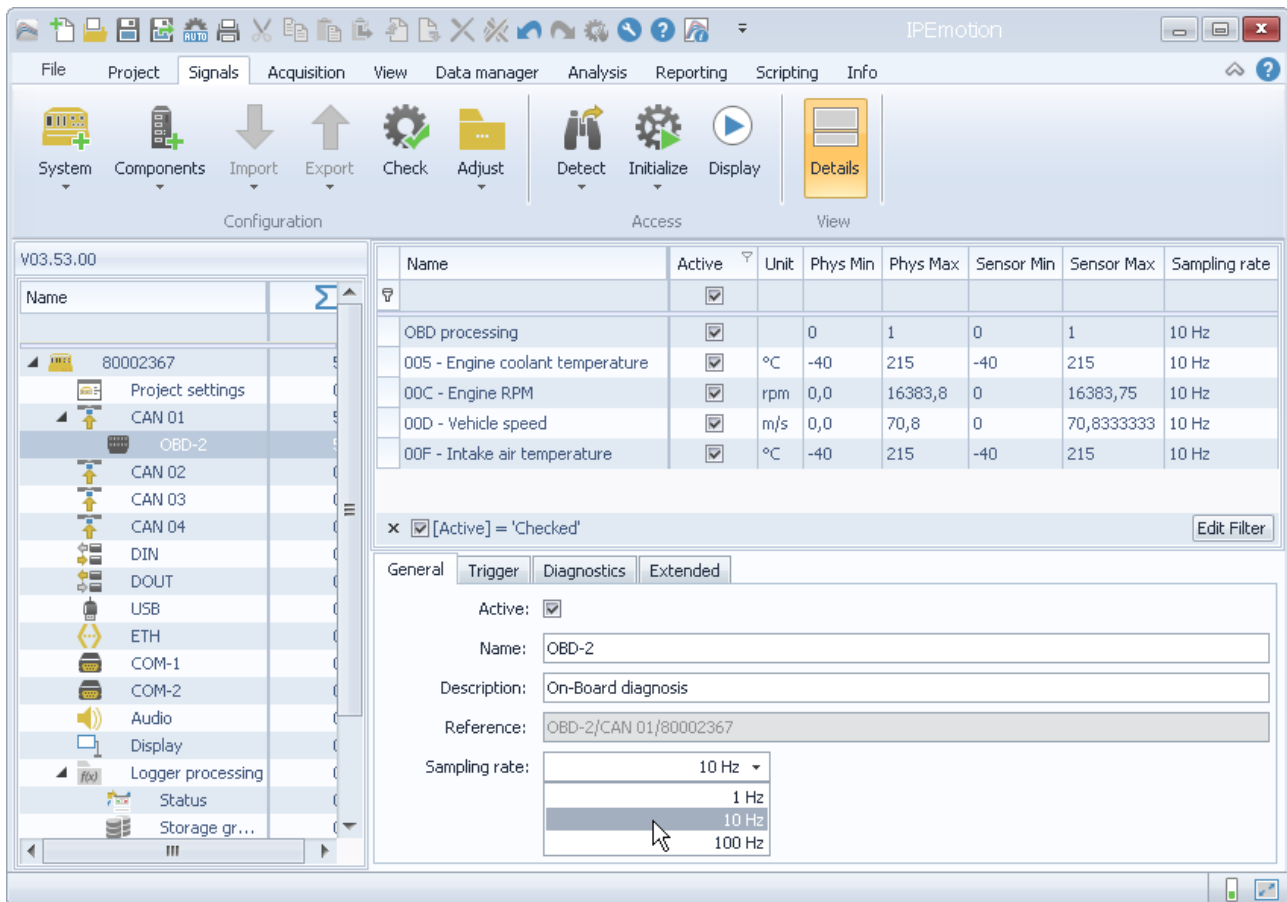

## OBD-2 Extensions (TESTdrive V03.52)

- ▶ Selectable data rate 1/ 10/ 100 Hz (depends on the ECU)
- ▶ Measurement start by trigger event
- ▶ Support of Extended IDs (29 Bit)
- ▶ PID single request support (each request to the ECU with a PID)
- ▶ Request delay (delay time between data receipt and sending the following request)

## 8.2.8 UDS protocol (Unified Diagnostic Services)

UDS protocol combines KWP2000, GMLAN, and DiagnosticOnCan in one protocol. An advantage is the clear session handling (higher compatibility of different control units). Furthermore, UDS supports modern memory structures, which require a > 32 Bit addressing.

The corresponding description file has the ODX extension.

Control units of some manufacturers already support UDS, which will be used as standard diagnostic in near future.

### Jobs overview

TESTdrive V03.15 supports the following jobs, which can be read via UDS:

- ▶ FS\_READ
- ▶ FS\_READ\_DETAIL
- ▶ IDENT
- ▶ READ\_DATA\_REFERENCE
- ▶ FG\_READ
- ▶ DYNAMICALLY\_DEFINE\_LOCAL\_ID

These jobs can be defined with an \*.idf file.

### Storing data

The results are optionally stored as binary file (\*.CSV and \*.J\*\*) or as trace and binary file (\*.CSV, \*.J\*\* and \*.T\*\*).

The files are identified as follows:

Single data detected via KWPOnCAN: (former description)	BDKxxxx.CSV bzw. BDKxxxx.Jxx BDJxxxx.CSV bzw. BDSxxxx.Jxx
UDS data detected via trace mode:	BDUxxxx.txx

### Selecting protocol

The UDS protocol is selected with the corresponding tab in the import module.



Read more details on the UDS protocol and relating applications from this document:  
**Manual ECU Diagnostics.pdf**

### 8.3 Recording GPS-Data

The GPS receiver GPS 18 and the NMEA protocol option, M-LOG, S-LOG, as well as, FLEETlog WAN with integrated GPS receiver support the continuous recording of GPS data with the global satellite navigation system. This functionality allows positioning and logging of test routes with a data rate of 1 Hz.

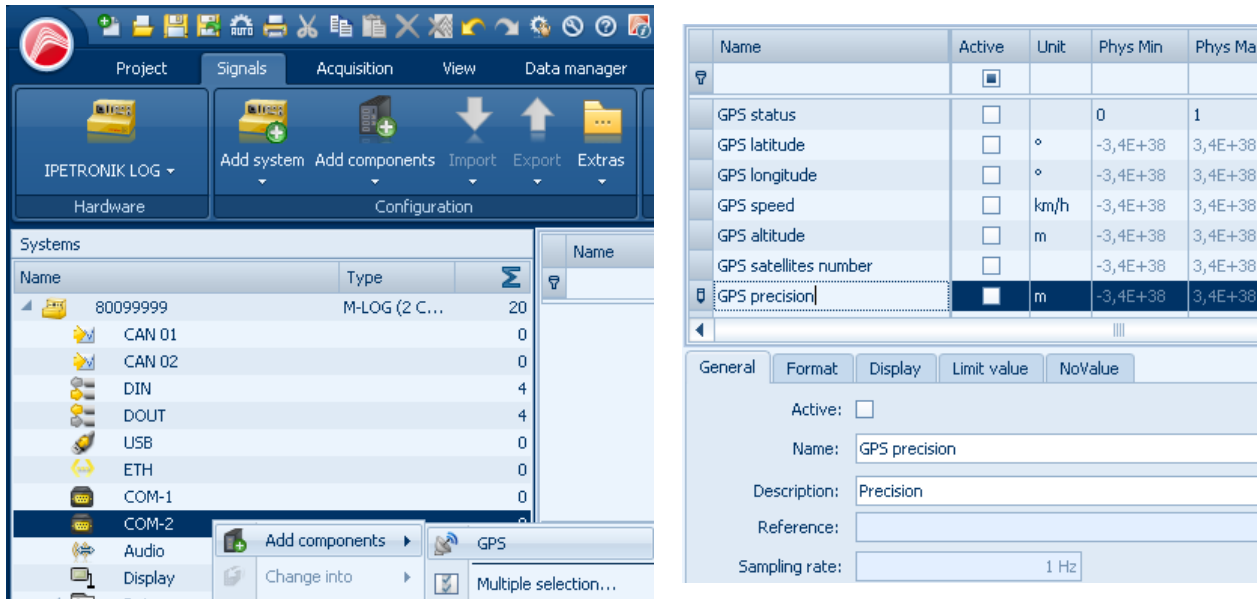

Name	Active	Unit	Phys Min	Phys Ma
GPS status	<input type="checkbox"/>		0	1
GPS latitude	<input type="checkbox"/>	°	-3,4E+38	3,4E+38
GPS longitude	<input type="checkbox"/>	°	-3,4E+38	3,4E+38
GPS speed	<input type="checkbox"/>	km/h	-3,4E+38	3,4E+38
GPS altitude	<input type="checkbox"/>	m	-3,4E+38	3,4E+38
GPS satellites number	<input type="checkbox"/>		-3,4E+38	3,4E+38
GPS precision	<input checked="" type="checkbox"/>	m	-3,4E+38	3,4E+38

General | Format | Display | Limit value | NoValue

Active:

Name: GPS precision

Description: Precision

Reference:

Sampling rate: 1 Hz

Predefined settings are available to configure the acquisition. The single channels are activated as required.



*The accuracy of the positioning data is considerably defined by the number of received satellites (12 satellites are in the geostationary orbit).*

*Due to physics, the accuracy of the height acquisition (Altitude) with this method is considerably lower than that of the length acquisition (Latitude = geographical width, Longitude = geographical length).*



*Different altitude signals with FLEETlog STD and FLEETlog WAN.*

*Depending on the GPS hardware of FLEETlog, the logger acquires altitudes which may differ from the reference height (geographic NHN). This behaviour is caused by the use of the "ellipsoidal height" for the height reference.*

*Please execute a calibration measurement on a height which is known exactly to verify GPS data of your logger system.*

## 8.4 Remote data transfer

The logger offers the availability of wireless data transfer by corresponding options. Single vehicles, as well as, entire vehicle fleets can be managed from one or several bases. Due to the worldwide good to excellent GSM network coverage, regional and global test drives can be managed from any base.

### 8.4.1 Transferring data using GPRS and Internet to FTP server

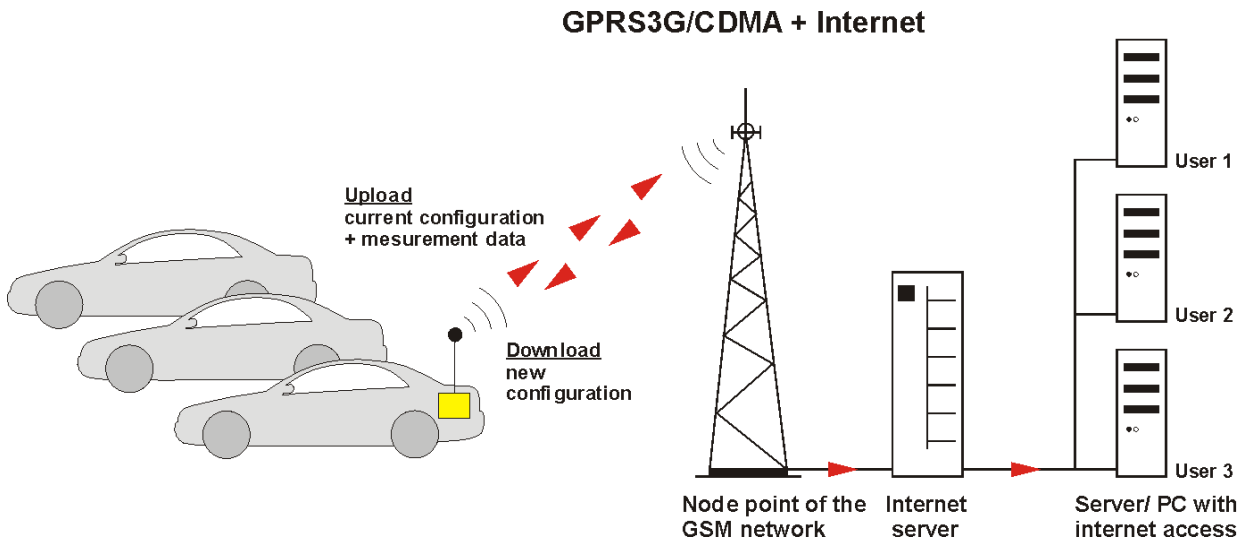

#### Components

- ▶ M-LOG/M-LOG V3, S-LOG, FLEETlog2, IPElog/IPElog2
- ▶ M-LOG, S-LOG with GPRS data transfer option with COMgate WAN, antenna, data transfer software or with modem, antenna, data transfer software
- ▶ Connecting cables
- ▶ SIM card for modem (depending on provider)

#### Functional principle

A logger in measuring mode continuously stores data as defined in the configuration. If the test series is completed (status of remote signal is inactive, e.g. terminal 15), data is packed and transferred via GPRS in GSM network to the next node point. This data is then transferred via internet to a FTP server for being available for download. All data transfer settings are defined in the IPETRONIK software.



## 8.4.2 Transferring data using Wireless LAN to network server

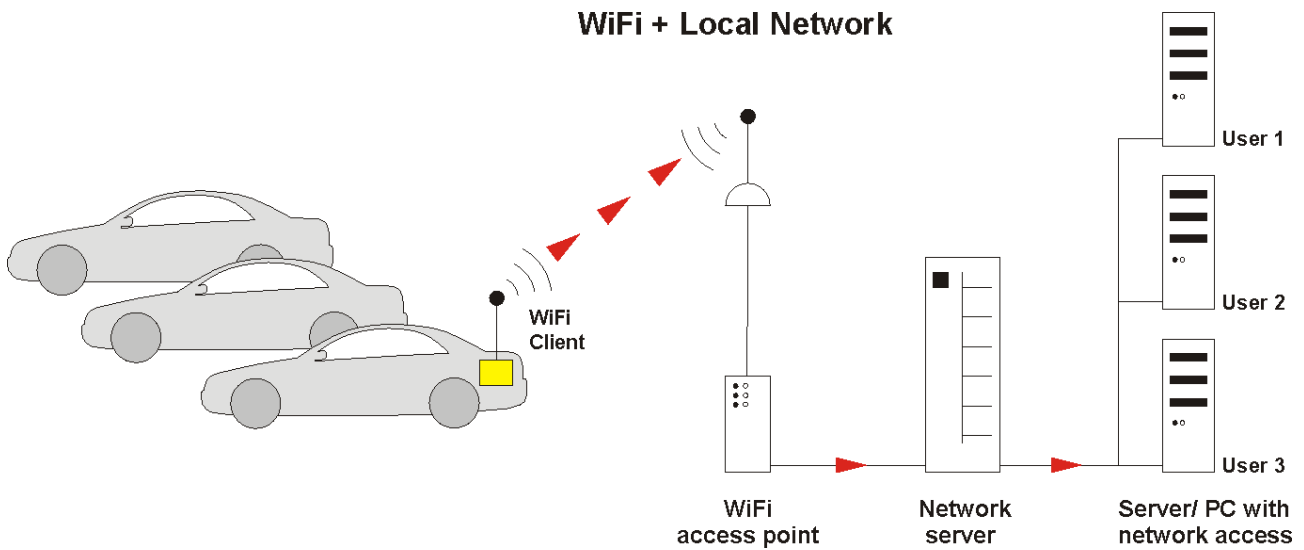

### Components

- ▶ M-LOG/M-LOG V3, S-LOG, FLEETlog2, IPElog/IPElog2
- ▶ M-LOG, S-LOG with WiFi data transfer option with COMgate, antenna, data transfer software or with client, antenna, WiFi software
- ▶ Connecting cables
- ▶ WiFi access point to connect with network (M-LOG, S-LOG)

### Funktional principle

A logger in measuring mode continuously stores data as defined in the configuration. If the test series is completed (status of remote signal is inactive, e.g. terminal 15), data is packed. If the vehicle is within reach of an access point (up to 300 m outdoors), data is transferred via WiFi to the access point. This data is then transferred via local network to a server. If the local network is connected to the internet, data can also be transferred to a FTP server for being available for download. All data transfer settings are defined in the IPETRONIK software. Due to multiple encoding options (transmission protocol and user), a very high degree of security against unauthorized access is guaranteed.

### 8.4.3 Data transfer configuration

The screenshot shows the IPEmotion software interface. The 'Data manager' tab is selected, and the 'Configuration' button is highlighted with a tooltip that reads "Configuration of connection parameters".

Name	Active	Unit	Phys Min	Phys Max	Sensor Min	Sensor Max	Sampling rate
DIN 01	<input checked="" type="checkbox"/>	0	1	0	1	10 Hz	
DIN 02	<input checked="" type="checkbox"/>	0	1	0	1	10 Hz	
DIN 03	<input checked="" type="checkbox"/>	0	1	0	1	10 Hz	
DIN 04	<input checked="" type="checkbox"/>	0	1	0	1	10 Hz	
DOUT 01	<input type="checkbox"/>	0	1	0	1	1 Hz	
DOUT 02	<input type="checkbox"/>	0	1	0	1	1 Hz	
DOUT 03	<input type="checkbox"/>	0	1	0	1	1 Hz	
DOUT 04	<input type="checkbox"/>	0	1	0	1	1 Hz	

Configuration options in the 'Data manager' tab:

- Update connection parameters:
- Compress files:
- Take configuration into measuring file:
- Take log file into measuring file:
- Background data transfer:



Activate **Update connection parameters** to enter the data transfer settings using the **Configuration** button.

To ensure an accurate data transfer after TESTdrive update to 3.52.01 or higher, you have to click this check box also, even if no modification has been made. (The current settings will be transferred to the logger in any case.)

The screenshot shows the 'Data transfer configuration: 80001707' dialog box, 'General' tab. The 'Medium selection' sub-tab is active.

Options in the 'Medium selection' sub-tab:

- Emergency switch-off after: 1 h
- File encoding:
- Activate data remote transfer:
- Time synchronization via SNTP:
- Activate e-mail delivery:

The screenshot shows the 'Data transfer configuration: 80001707' dialog box, 'COMgate transfer' sub-tab.

Options in the 'COMgate transfer' sub-tab:

- LAN:
- Modem:
- COMgate:

## 8.5 Configuring COMgate

### COMgate transfer

#### Modem (3G/HSPA/UMTS)

Data transfer by internal modem (COMgate WAN only).

#### Wireless LAN (WiFi)

Data transfer by internal WiFi client.

#### Access Point (AP)

COMgate operates as WiFi access point.

#### Hotspot

Hotspot (public WiFi access point, e.g. T-Mobile for Germany) to connect the internet.  
(Only with Wireless LAN activated!)

#### Cisco VPN

Encrypted data transfer through VPN tunnel.

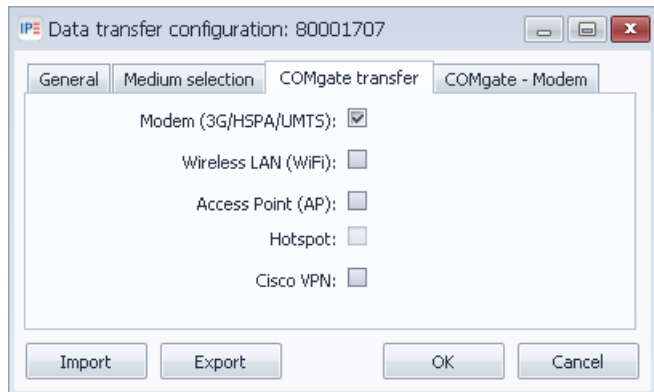

### COMgate - Modem

#### Predefined provider

Select a predefined provider from the drop down list (use of provided standard settings).

Provider: T-Online, Vodafone, O2, E-Plus

#### PIN code

Identification number of the SIM card

#### Authentication

Access authorisation by **User name** and **Password**.

#### Access point (APN)

Name of the access point for the modem connection (APN = Access Point-Name).

#### Data roaming off

Data transfer enabled only for the defined provider (radio network availability provided)

#### Provider (MCC+MNC)

**Mobile Country Code** and **Mobile Network Code** are required identification numbers for manually setting of the radio network provider.

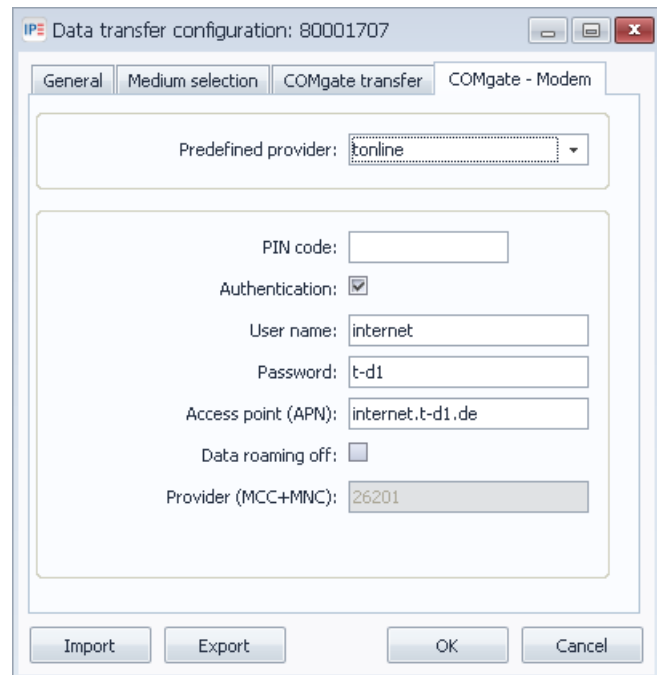

**COMgate transfer****Modem (3G/HSPA/UMTS)**

Data transfer by internal modem (COMgate WAN only).

**Wireless LAN (WiFi)**

Data transfer by internal WiFi client.

**Access Point (AP)**

COMgate operates as WiFi access point.

**Hotspot**

Hotspot (public WiFi access point, e.g. T-Mobile for Germany) to connect the internet.  
(Only with Wireless LAN activated!)

**Cisco VPN**

Encrypted data transfer through VPN tunnel.

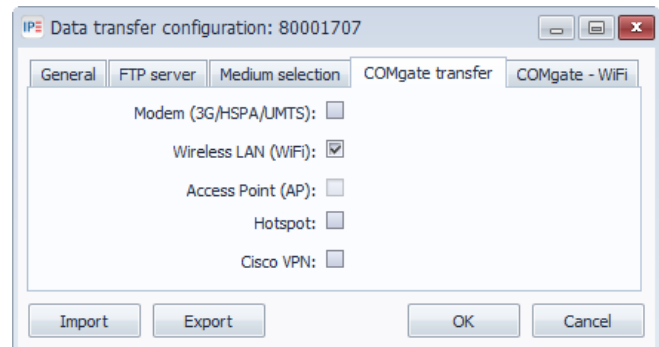
**COMgate - WiFi****SSID**

Net work name of the related access point  
(Service Set Identifier)

**Security**

WiFi transfer protocol WPA, WPA2,  
Radius, MSCHAPV2

**Password**

Password for user access.

**User identification**

User name for user access.

**Certificate**

File providing the certificate for the respective  
network connection.

**DHCP**

Automatic handling of IP addresses (IP assignment)  
in the network by a server supporting DHCP.

**IP address**

Manually assigned client IP address

**Sub net mask**

IP address range of the sub network

**Standard gateway**

Network address of the standard gateway

**Preferred DNS server**

Address of the 1st name server (DNS =  
Domain Name System) to link the host name, in case  
that only the name of the target server has been  
entered.

**Alternative DNS server**

Address of the 2nd name server as fall back, in case  
the 1st DNS server is not available.

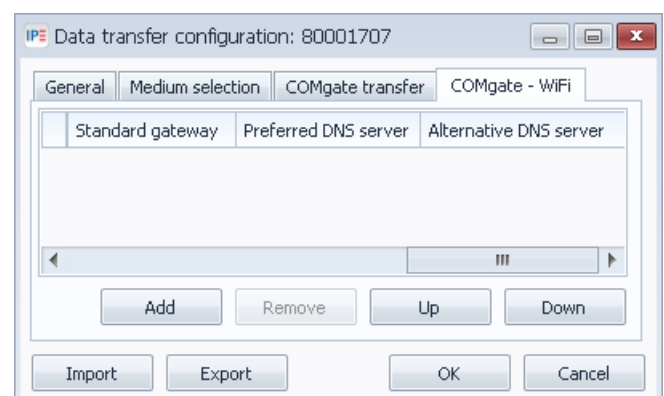
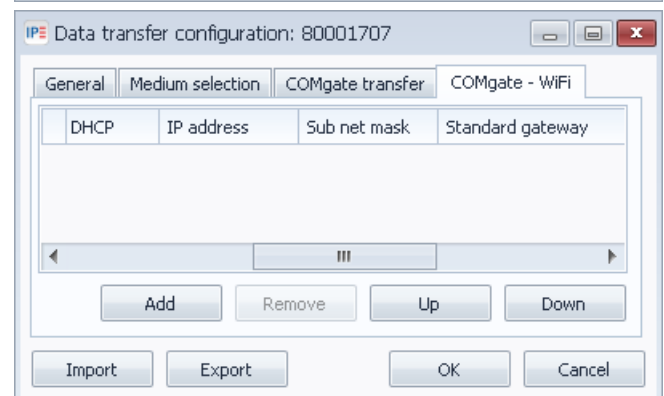
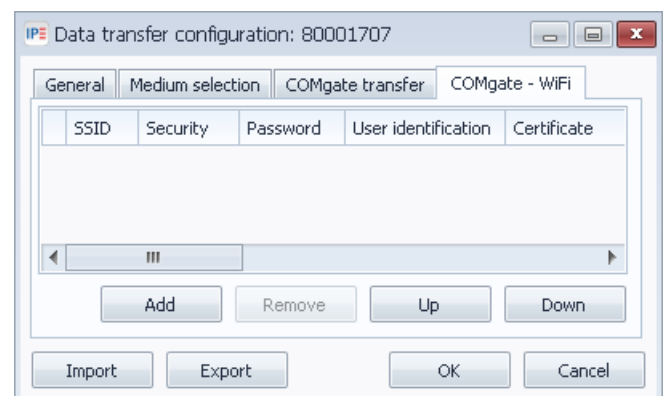

**COMgate transfer****Modem (3G/HSPA/UMTS)**

Data transfer by internal modem (COMgate WAN only).

**Wireless LAN (WiFi)**

Data transfer by internal WiFi client.

**Access Point (AP)**

COMgate operates as WiFi access point.

**Hotspot**

Hotspot (public WiFi access point, e.g. T-Mobile for Germany) to connect the internet. (Only with Wireless LAN activated!)

**Cisco VPN**

Encrypted data transfer through VPN tunnel.

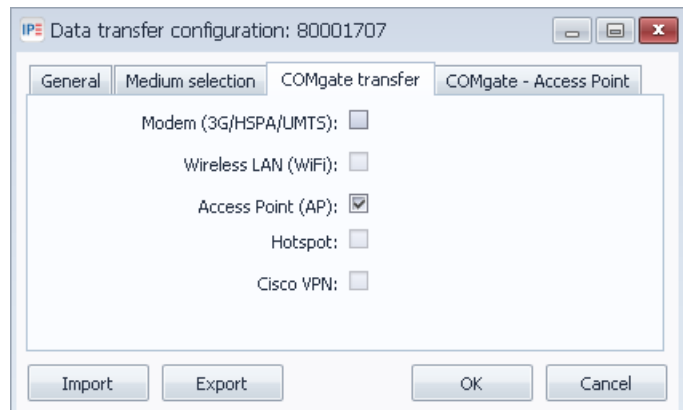
**COMgate - Access Point****SSID**

Net work name of the related access point (Service Set Identifier)

**Password**

Net work password

**IP address**

COMgate IP address

**Sub net mask**

IP address range of the sub network

**WiFi channel**

Selection of the WiFi channel and the associated carrier frequency.

**Activate DHCP server**

COMgate acts as host with automatic IP address assignment for the clients.

**First available IP address**

Lower bound of the IP range, e.g. 198.164.0.101

**Last available IP address**

Upper bound of the IP range, e.g. 198.164.0.110

**Security**

WiFi transfer protocol WPA2

**Encoding**

Security protocol (Temporal Key Integrity Protocol)

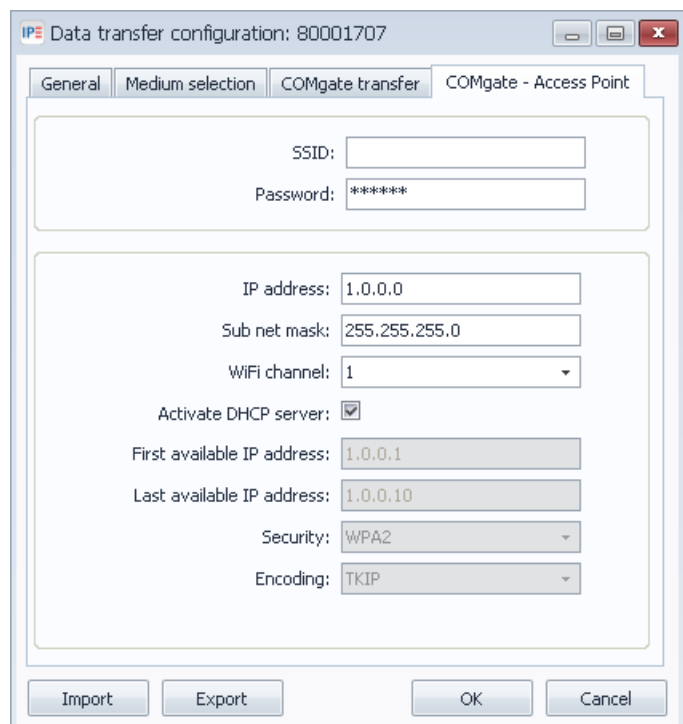

COMgate also provides XCP data transfer from the logger system to a mobile device (with Android operating system) by a WiFi connection. Please read more details regarding to the online data visualization (using XCP service) with the IPEmotion App in this manual:

***IPEmotion-App-V02.xx.pdf*** .

IPETRONIK Data transfer configuration: 80001707

General Medium selection COMgate transfer COMgate - WiFi COMgate - Hotspot

Modem (3G/HSPA/UMTS):

Wireless LAN (WiFi):

Access Point (AP):

Hotspot:

Cisco VPN:

Import Export OK Cancel

**COMgate - Hotspot****Predefined provider**

Select a predefined provider from the drop down (use of provided standard settings).

Provider: T-Online

**Provider**

Name of the provider (entered manually)

**User name**

User name to access the account.

**Password**

Pass word to access the account.

**LoginCommand**

Login command to to access the account.

IPETRONIK Data transfer configuration: 80001707

General Medium selection COMgate transfer COMgate - WiFi COMgate - Hotspot

Predefined provider:

Provider:

User name:

Password:

LoginCommand:

Import Export OK Cancel

IPETRONIK Data transfer configuration: 80001707

General Medium selection COMgate transfer COMgate - WiFi COMgate - Cisco VPN

Modem (3G/HSPA/UMTS):

Wireless LAN (WiFi):

Access Point (AP):

Hotspot:

Cisco VPN:

Import Export OK Cancel

**COMgate - Cisco VPN****Gateway IP address**

Network IP address of the gateway used for data transfer.

**User ID**

User identification

**Key (PSK)**

Pre-shared key used by two different peer systems identifying each other.

**User name**

User name to access the account.

**Password**

Password to access the account.

IPETRONIK Data transfer configuration: 80001707

General Medium selection COMgate transfer COMgate - WiFi COMgate - Cisco VPN

Gateway IP address:

User ID:

Key (PSK):

User name:

Password:

Import Export OK Cancel

## 9 Display modules

### 9.1 M-VIEWfleet

M-VIEWfleet is a alphanumeric data display, which is connected to the USB of the logger. M-VIEWfleet provides different displaying modes besides four status LEDs and buttons. The number of displayed channels is only limited by the processor load.



**Only connect M-VIEWfleet to the logger if logger is switched-off.** In case M-VIEWfleet is connected to logger during operation, the USB interface can be damaged.

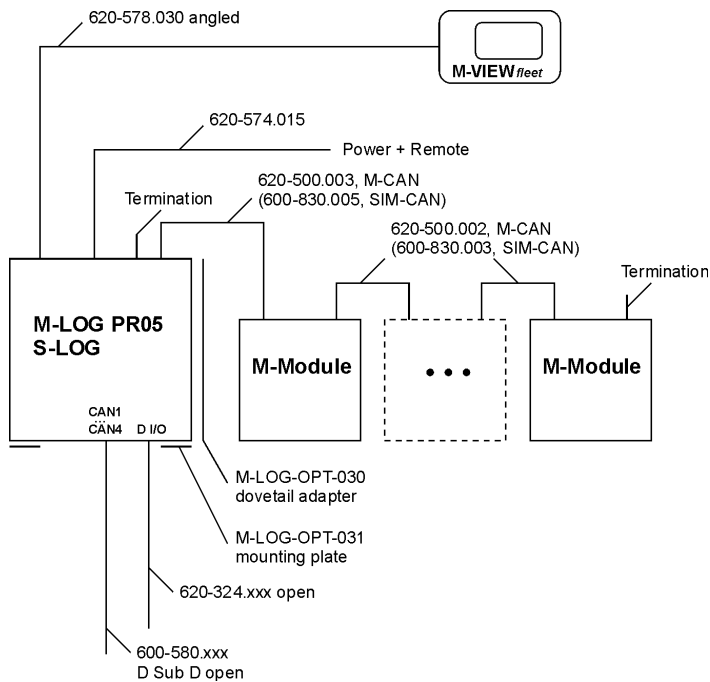

M-VIEWfleet is connected to M-LOG with an USB 2.0 interface. A second USB port of the logger is available at the display. USB 2 is used for e.g. a program update or to exchange measurement or configuration data via USB flash drive. USB connections are designed for a maximum length of 5 m. Display settings are defined in the system configuration.

### 9.1.1 Keys and LEDs

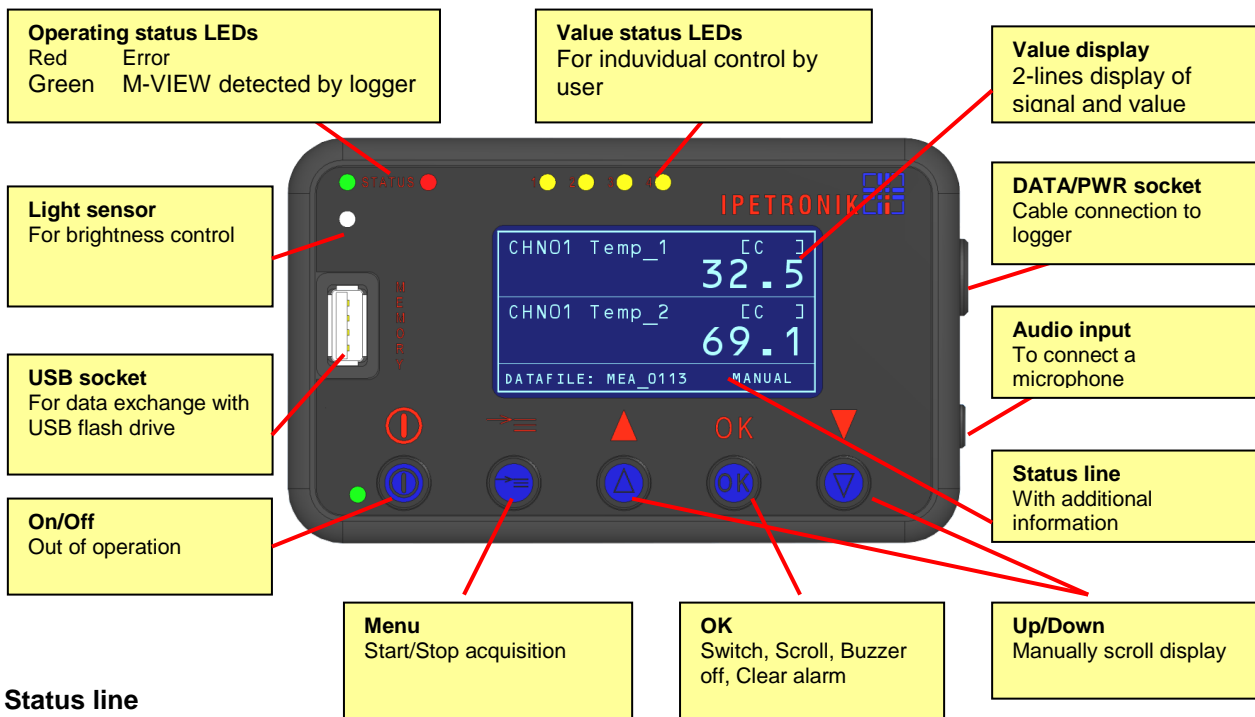

#### Status line

The scroll mode **MANUAL** (with Up/Down keys) or **AUTO** (automatically) is displayed in the right zone of the status line. The following information is alternately shown in the left zone:

- DATAFILE      Name of current data file
- TIME LEFT     Available time in days (D) and hours (H) for data recording
- DRIVER        Selected driver
- SHIFT         Selected shift (track or road sections belonging together)

#### OK

Function in standard display

1.      Display Min/Max                      Press longer than one second
2.      Back to standard display            Press longer than one second

Function in standard display in scroll mode AUTO:

(Changed from AUTO to MANUAL with Up/Down keys)

1.      Back to auto scroll mode            Press longer than one second

If the key is not pressed, the display changes after 30 s into auto scroll mode.

Switching from MANUAL to AUTO is only possible if auto scroll mode has been activated!

Function at configured alarm limit values:

1.      Buzzer off                              Shortly press to switch-off buzzer
2.      Clear alarm                              Press longer than one second, Back to standard view

If the alarm has already been cleared 5 times, a final message appears to definitely delete the alarm.

#### Up/Down ▲ ▼

- One line up                                      ▲
- One line down                                   ▼
- Switch AUTO > MANUAL                    ▲ or ▼ if AUTO (Auto scrolling) has been activated in configuration



**Menu**

Stop acquisition -> Press longer than two seconds

Start acquisition -> Press longer than two seconds



The option **Allow start and stop of acquisition** must be activated in the configuration. The measurement file number is increased by one at every acquisition start. If the option **Track** or **Track/Driver** (List type selection) is additionally selected, files can be merged to one file until the final end of data recording.

Devices connected to the logger **remain switched-off until acquisition stop**.

**Operating status LEDs**

- Red    1. Error
- 2. Logger is booting, initializing M-VIEW
- Green    Operation, M-VIEW detected by logger

**Value status LEDs**

The 4 status LEDs can be controlled with calculations. Additional limit violations can therefore individually be displayed.

**9.1.2 Configuring M-VIEWfleet**

- ▶ Select Display in the tree structure.
- ▶ Select Add components.
- ▶ Select M-VIEWfleet.
- ▶ Select the desired signals.
- ▶ Confirm the desired signals with **OK**.



Define the alarm values for the upper and lower signal limit, if desired. If the current signal reaches the alarm limit, the display changes into the message window and the buzzer sounds. Clear the alarm with OK.

Activate the detection of the minimum and/or maximum values for the respective signal. With pressing OK, the display changes into showing the minima and maxima. If the detection has not been activated, -----.-- is shown. Pressing OK again changes back to standard display.

### Define status LEDs for limit display

The 4 status LEDs can be activated by separate and user-defined calculation formulas. Additional thresholds can therefore be defined and reaching these limits can optically be signaled. In addition, the LEDs can be used as status display for the 4 digital logger outputs.

To do so, the following options are available:

- ▶ Use the same formula like at the corresponding digital output
- ▶ Status query of digital output to 1 (LED ON, for the time digital output = 1)

Name	Active	Unit	Phys Min	Phys Max	Senso
LED 01	<input type="checkbox"/>		0	1	0
LED 02	<input type="checkbox"/>		0	1	0
LED 03	<input type="checkbox"/>		0	1	0
LED 04	<input type="checkbox"/>		0	1	0

Formula: "DIN 01"=1

### Setting display modes

Select **Active** to use M-VIEWfleet in the configuration.



*No further settings can be defined without activating M-VIEWfleet! If an existing M-VIEWfleet configuration is deactivated, the logger display has no function! This is signaled by the red LED. The red LED is also on if the USB port is damaged during operation by disconnecting the cable.*

Mode

Scroll mode:

List type:

Allow start and stop of acquisition:

Merge measurement files:

Confirm shift/track at stop:

**Scroll mode**

- Off Manually switching lines with Up/Down
- 5 s Continuous line switching in interval of 5 s, display moves line by line from the bottom up in order of signal list

**List type**

- Off Neither track nor driver defined
- Track Track selection by driver is assigned in data
- Track/driver Track, as well as, driver are selected before start and set in data

The text file of the track selection list is defined in:

...\IPETRONIK\IPEmotion MAL-PlugIn IPETRONIK LOG V03.xx.xx\Data\MViewfleet\MVIEWfleetTracks.txt

The text file of the driver selection list is defined in:

...\IPETRONIK\IPEmotion MAL-PlugIn IPETRONIK LOG V03.xx.xx\Data\MViewfleet\MVIEWfleetDrivers.txt

Changes of the entries can manually be defined in the respective text file.

**Allow start and stop of acquisition**

Pressing the menu key stops the data storage and the current measurement file is closed.

Pressing the menu key again starts the next data storage and the number of measurement file is increased by one.

**Merge measurement files**

This function requires a selected list type!

The end of every acquisition includes the **End Shift xxx** query. If it is confirmed with OK, all previous partial acquisitions of one file are merged and the number for the next measurement file is increased by one. If this function is not activated, an own file is written after every acquisition stop and a following acquisition is recorded with a new number.

**Confirm shift/track at stop**

A selected list type is required for this function and *Merge measurement files* must be activated!

The query runs after acquisition stop:

- |                       |                |                                                                           |
|-----------------------|----------------|---------------------------------------------------------------------------|
| <b>End Shift xxx!</b> | <b>Yes OK?</b> | Track is stopped, partial acquisitions are merged in one measurement file |
|                       | <b>No OK?</b>  | Track is continued at next start with same measurement file               |

The query runs after acquisition start:

- |                             |                   |                                                              |
|-----------------------------|-------------------|--------------------------------------------------------------|
| <b>Shift xxx Good Trip!</b> | <b>OK?</b>        | Currently saved track is continued with new acquisition file |
|                             | <b>Change OK?</b> | Track and driver can be selected again                       |



*If nothing is entered after a query, an acoustic message sounds after 20 s and the saved settings are accepted for the next acquisition.*

## 9.2 IPEconnect (Online display with Smartphone or tablet)

IPEconnect serves as an online display for IPETRONIK data loggers. The system consists of the components data logger (M-LOG, IPElog, FLEETlog), IPEhub2, corresponding connecting cables and the mobile device (Smartphone, tablet) with the IPEmotion App.

### 9.2.1 Overview

- ▶ Smartphone / tablet for online data visualization of the data acquisition running on the logger
- ▶ WiFi access point IPEhub2 as gateway from the logger to the Android display
- ▶ System configuration with IPEmotion
- ▶ Quick installation, easy and stable operation

**Minimum requirements**

- IPEmotion 2015 R3
- PlugIn IPETRONIK-LOG V03.56
- IPEmotion App V02.13
- IPEhub2 Firmware V01.03
- IPEhub2 with IPEconnect license

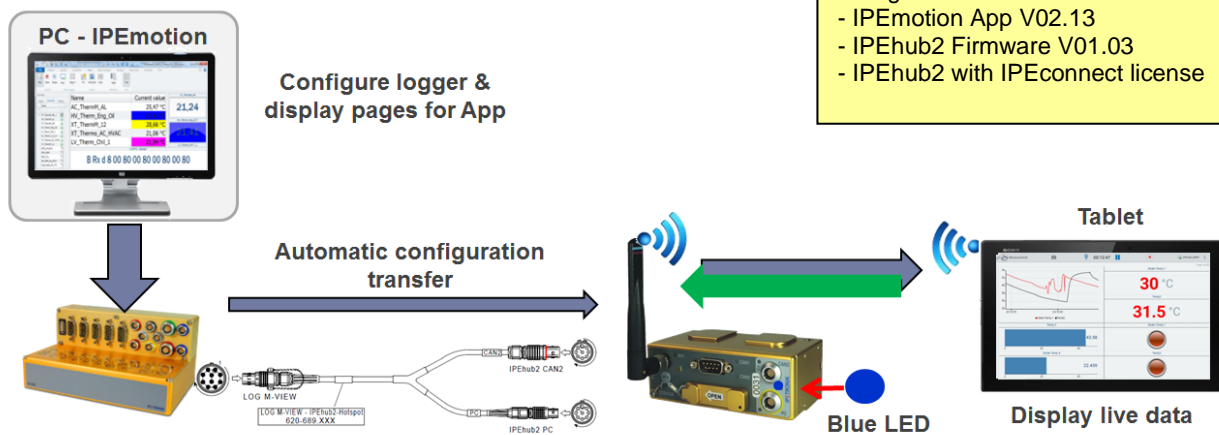

### 9.2.2 Features

- ▶ Creating the data configuration (online data) based on the logger measurement configuration.
- ▶ The IPEmotion App imports a new configuration automatically.
- ▶ Creating the configuration for the online visualization with the mobile device.
- ▶ The blue LED at IPEhub2 indicates a successful WiFi connection. Name of the network / SSID: Logger\_[Serial\_number]
- ▶ The app configuration on the smartphone / tablet is saved on IPEhub2.
- ▶ Shortly after the app has been started, it shows all defined values.
- ▶ IPEhub2 can be connected and disconnected at any time (even during a running measurement).
- ▶ If a connection is disturbed or interrupted, IPEhub2 will re-establish the WiFi connection immediately.

### 9.2.3 Cables

#### 620-689.xxx LOG-VIEW Cable IPEconnect (M-LOG, M-LOG V3, IPElog)

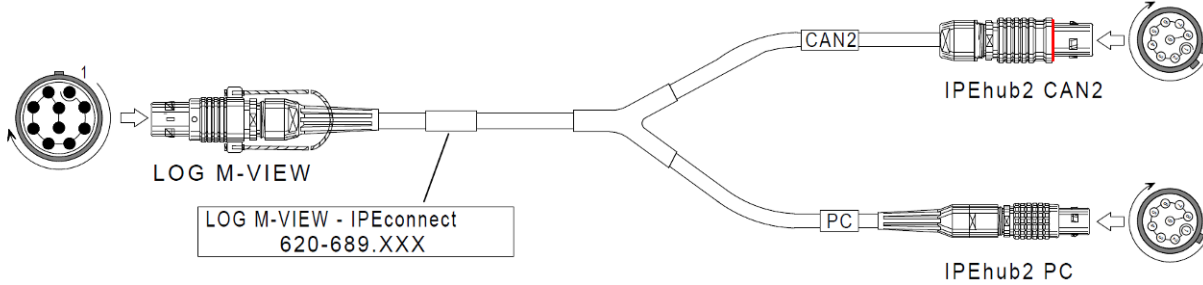

#### 620-691.xxx FLEETlog-VIEW Cable IPEconnect (FLEETlog, FLEETlog2)

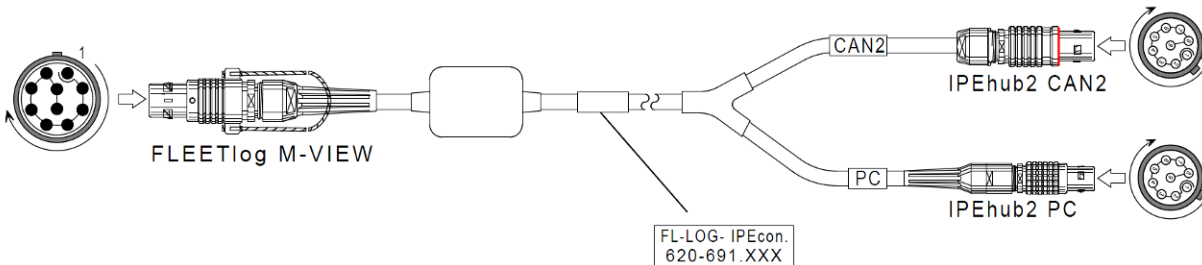

### 9.2.4 Settings

#### Logger USB interface

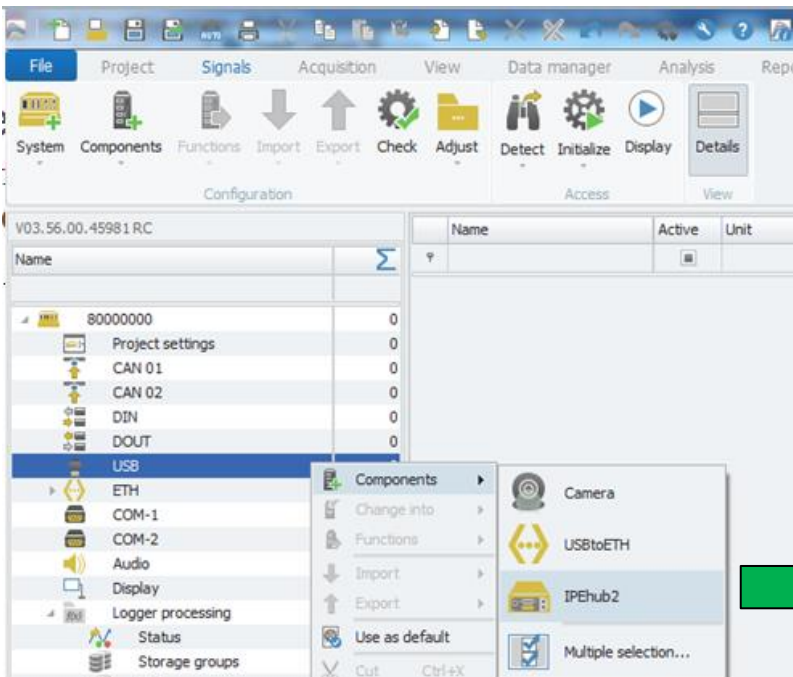

- Setup IPEhub2 at the logger's USB interface

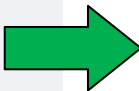

Name	Active	Unit
80000000	0	
Project settings	0	
CAN 01	0	
CAN 02	0	
DIN	0	
DOUT	0	
USB		
ETH		
COM-1		
COM-2		
Audio		
Display		
Logger processing		
Status		
Storage groups		
Camera		
USBtoETH		
IPEhub2		
Multiple selection...		
USB	0	
IPEhub2	0	
XCP service	14	
DAQ list slow	2	
DAQ list medium	12	

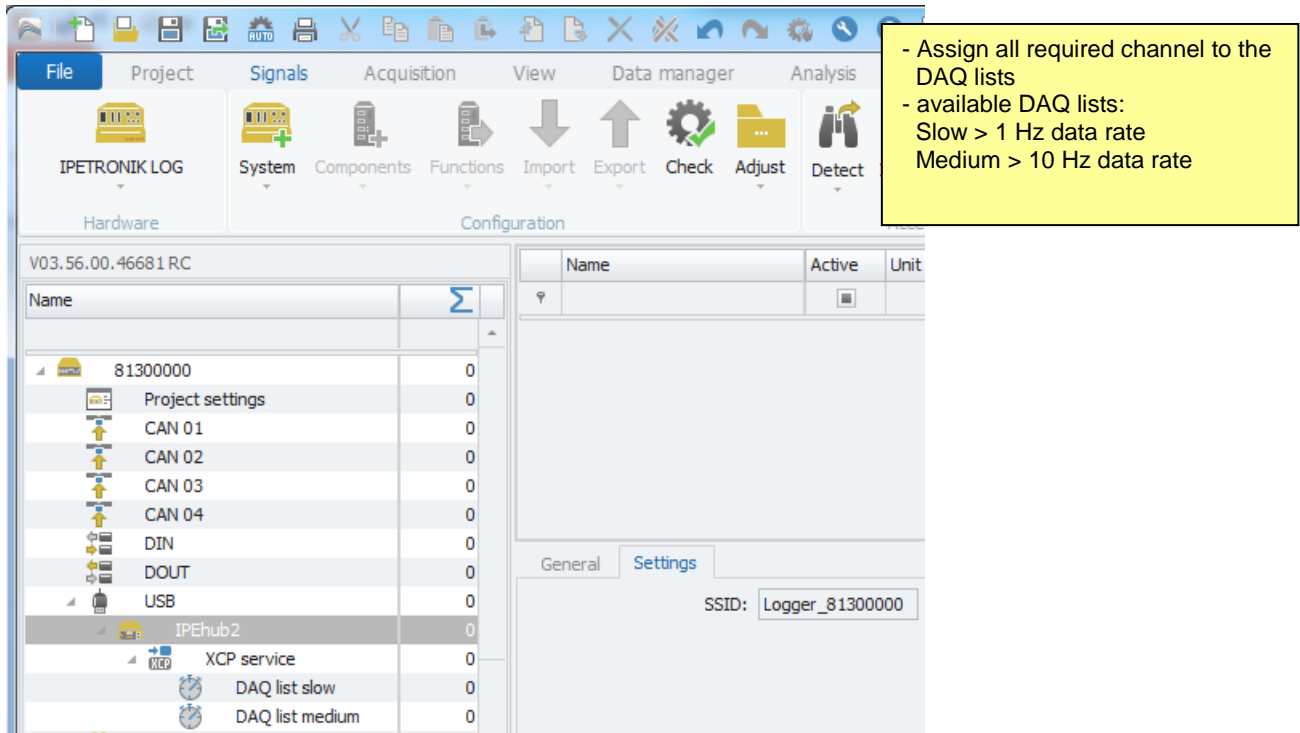

### App export

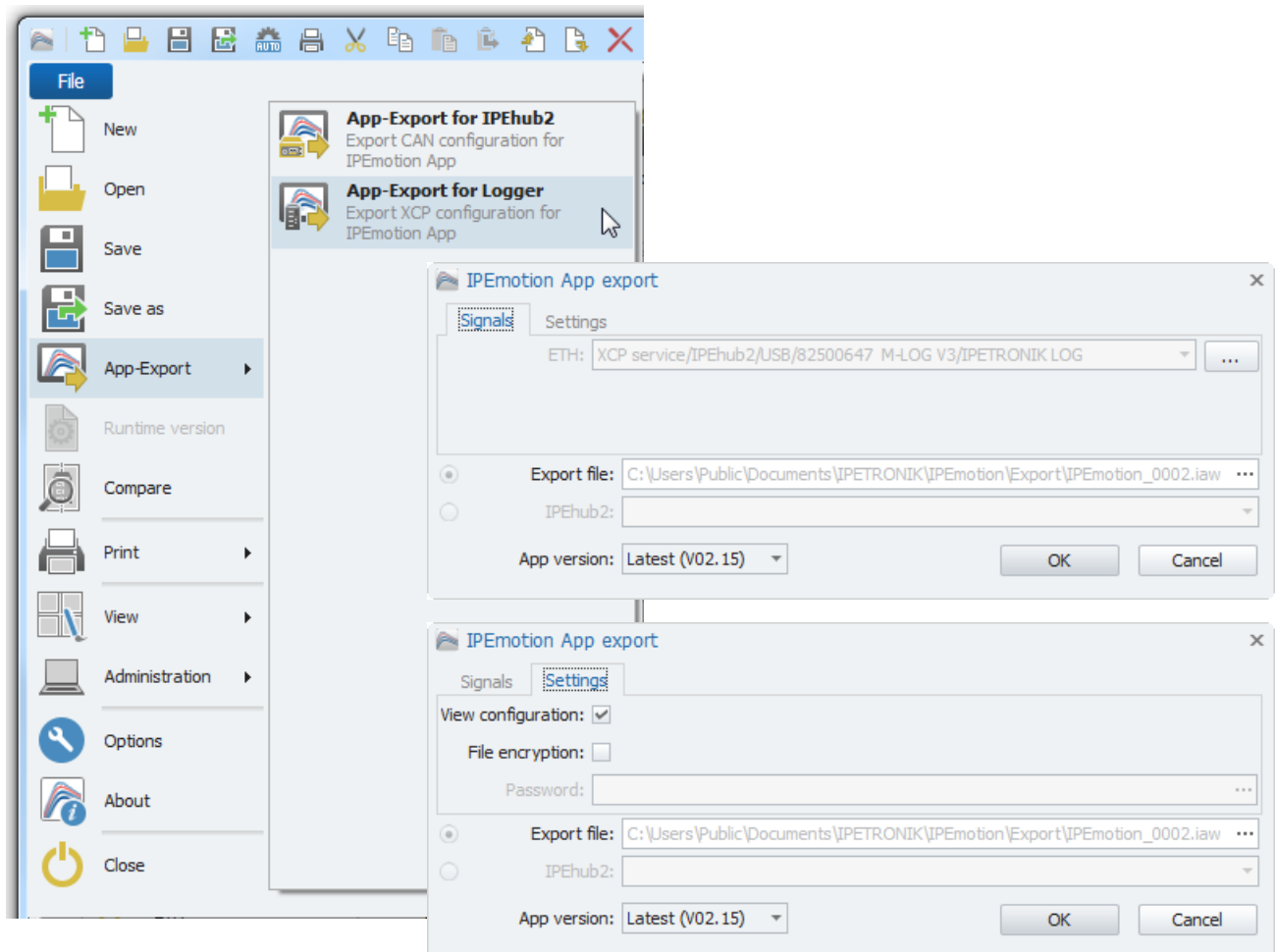

### 9.2.5 App display

The app shows consecutively signal values as soon as the WiFi connection is established and the logger is operating in measurement mode.

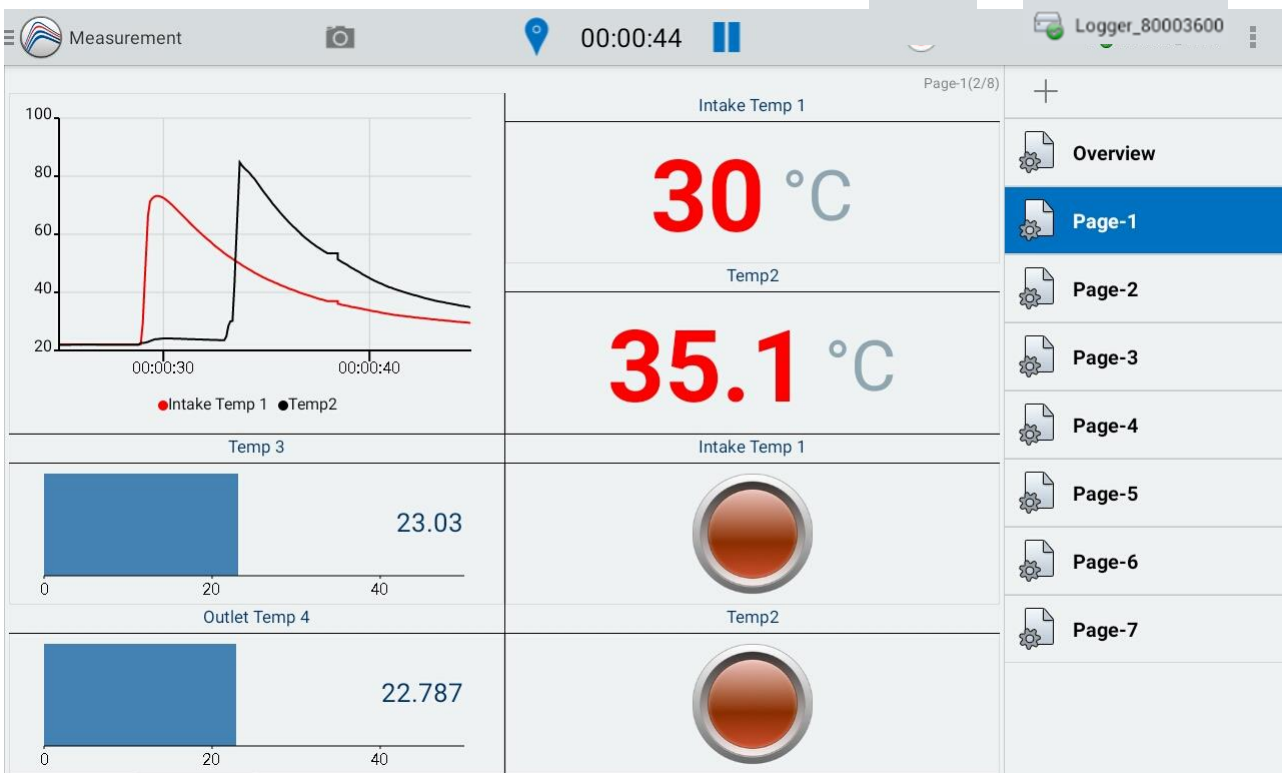

### 9.3 Connecting displays via openABK

With the implementation of the protocol openABK (short for open display and operating concept) in the PlugIn IPETRONIK-LOG V03.60 (and corresponding TESTdrive V03.60) standard displays that are supporting this protocol (e.g. the EMBU-Sys displays from the CANDICE series) are supported.

#### 9.3.1 Cable connection

The display can be used for data loggers IPElog2, M-LOG V3 and FLEETlog2 with an USB2ETH cable connected to the VIEW socket of the logger.

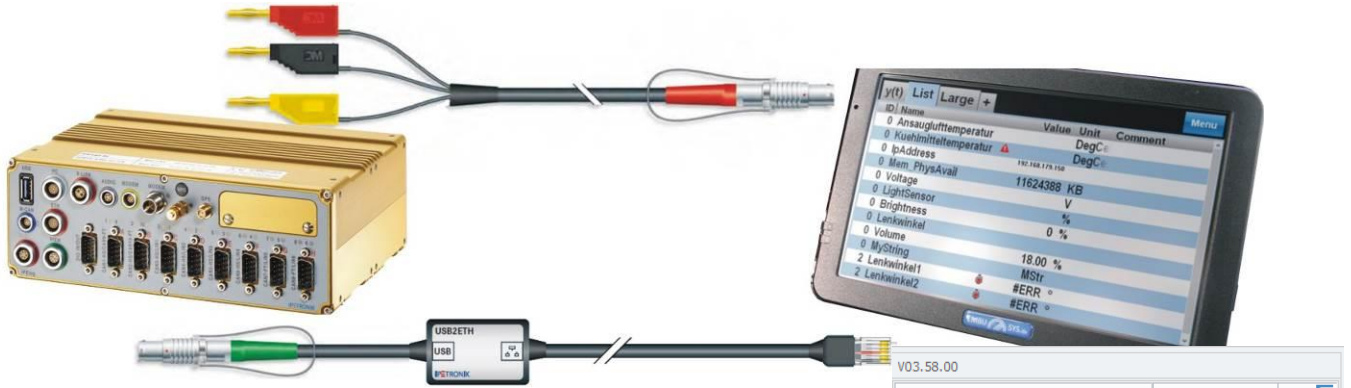

#### 9.3.2 Display configuration

The configuration of the measurement data visualization is set by the software of the display manufacturer. For CANDICE the EMBU-Sketch software offers an individual configuration of display instruments and function buttons. Furthermore, the display has to be created within the logger configuration by adding an USB component.

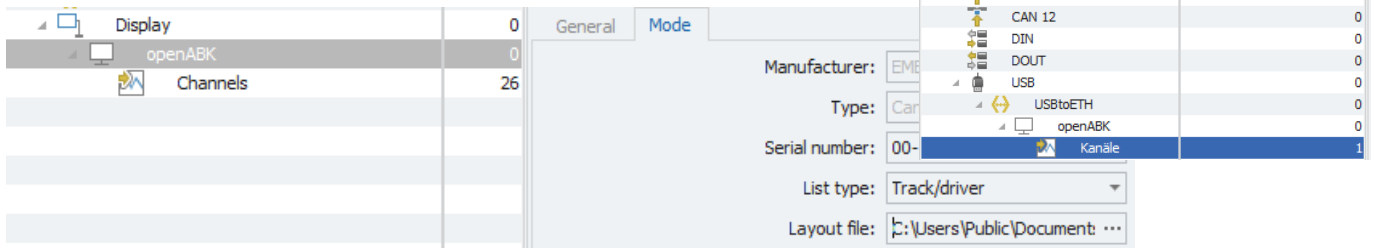

#### 9.3.3 Use display buttons for triggering

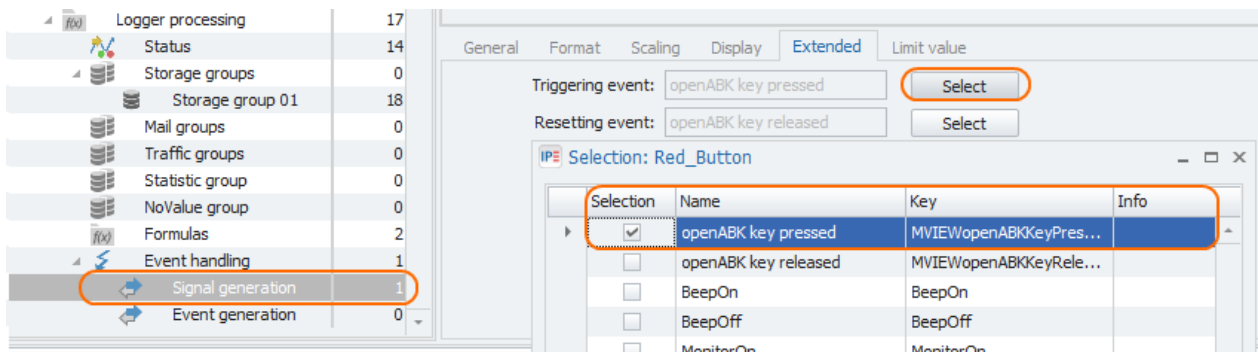



## 10 Accessories

### 10.1 Electrical accessories

#### 10.1.1 COMgate

COMgate is an intelligent extension device for logger and allows remote transmission of measurement and configuration data.

M-COMgate in mounting enclosure for M-LOG

COMgate is available in 2 versions:

COMgate                      WLAN acc. to WiFi 802.11 a/b/g

COMgate WAN                WLAN acc. to WiFi 802.11 a/b/g  
and modem for GSM/GPRS/3G

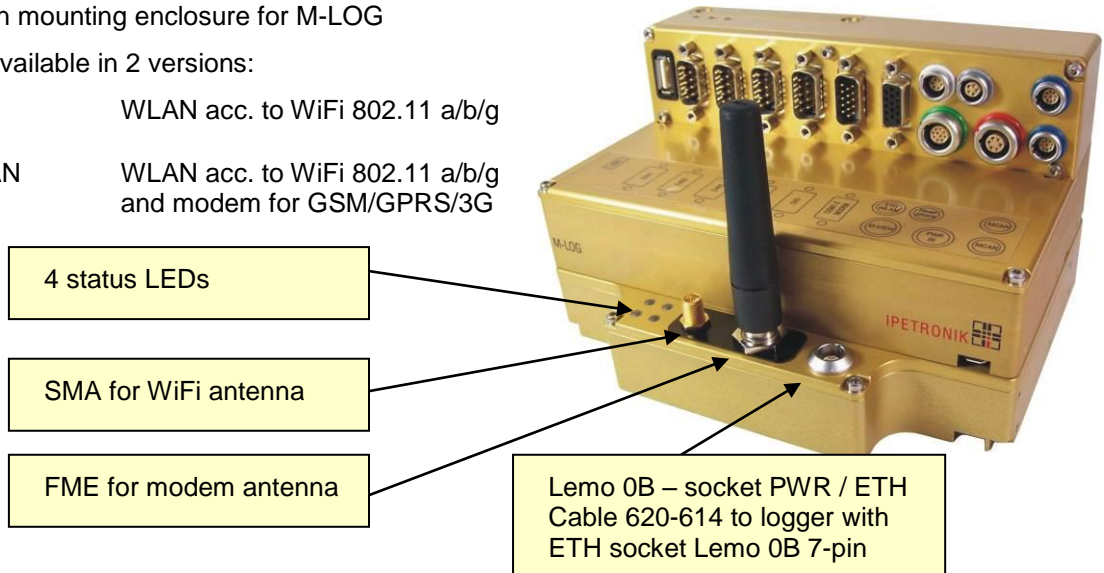

#### LED status display

LED display	Status	Meaning
<b>GREEN</b>	PWR ON	Device is ready for operation (operation: see LED yellow or orange)
■    ■    ■    ■	MODEM	Establishing connection to UMTS/GPRS network
■    ■    ■    ■	MODEM	Successfully registered to UMTS/GPRS network
<b>ORANGE</b>	MODEM	Steady connection
■    ■    ■    ■	WiFi	Establishing connection to WiFi network
■    ■    ■    ■	WiFi	Successfully registered to WiFi network
<b>YELLOW</b>	WiFi	Steady connection.
<b>RED</b>	ERROR	Interference, potential reasons are: - transfer of new configuration - wrong configuration loaded - general operating interference



*M-COMgate requires additional external cooling on M-LOG at operating in ambient temperatures > 70 °C (158 °F)!*

### 10.1.2 CAN Extender

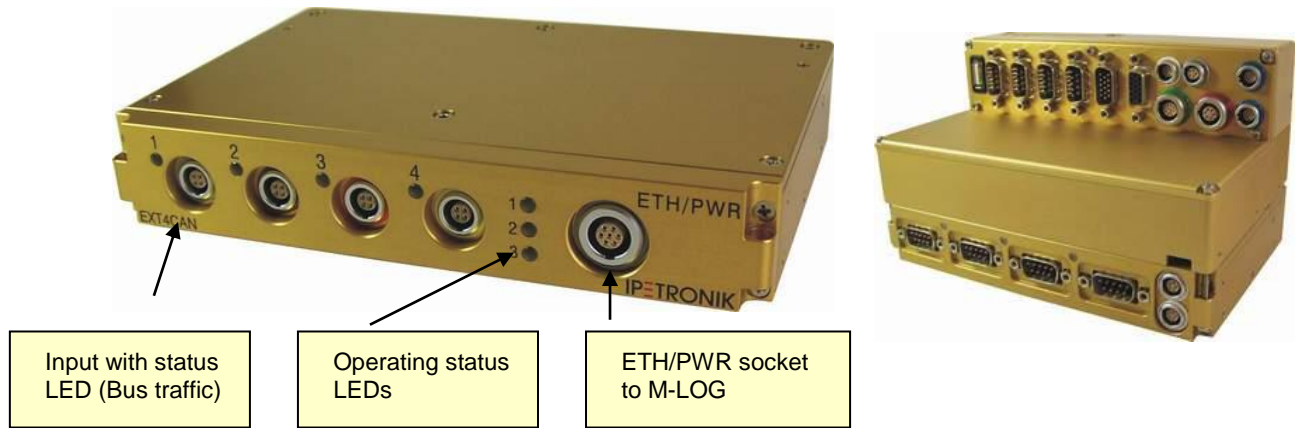

M-LOG Extender is an extension device with 4 additional CAN inputs. M-LOG devices, which are already equipped with a LX800 processor board, as well as, the option Input 2x Ethernet, can be extended without modifying hardware. The extender is screwed to the bottom of the basis device with 4 screws and connected to the logger with the cable 620-406.002 (here PR08, or 620-404.002 for PR03 and 620-405.002 for PR04).

#### Requirements

- ▶ Data logger with LX800
- ▶ Option Input 2x Ethernet (with respective port replicator)
- ▶ free Ethernet input
- ▶ IPEmotion + LOG-PlugIn ≥ 03.19 (Creation and configuration see ETH 01/02 port)

#### Advices

- ▶ The bus inputs of the extender do not support WakeOnCAN and traffic acquisition.
- ▶ Data is directly stored on the logger.
- ▶ The maximum data rate is 100 Hz.
- ▶ The configuration is extended by the additional file \*.ecf (Extender Configuration File).

### 10.1.3 IPEwifi

IPEwifi is as wireless extension for IPETRONIK data loggers (M-LOG, S-LOG) supporting radio data transfer using the WiFi standard 802.11 b/g.

Measurement data is transferred on command or automatically without any cable connection to a network access point. IPEwifi acts as a communication bridge and forwards measurement and configuration data. IPEwifi itself neither supports router functions nor subnetworks.

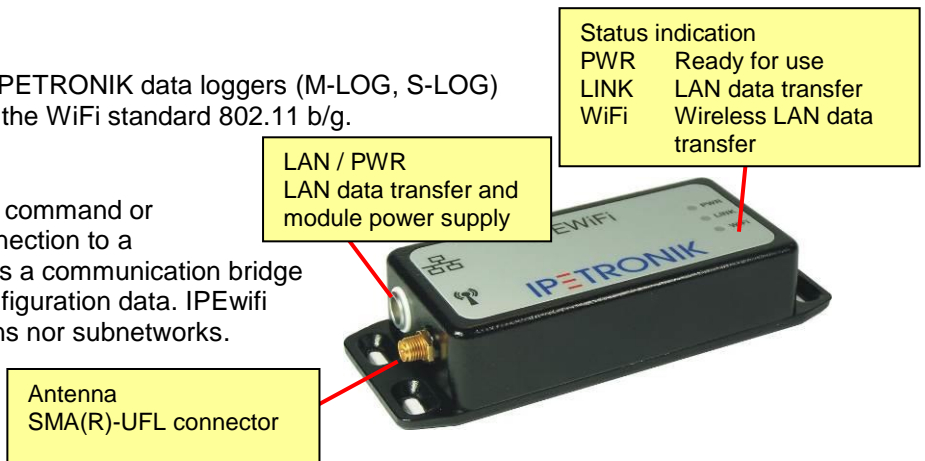

IPEwifi setup via web browser,  
 ► refer to separate manual IPEwifi

### Setting up a LAN connection for the logger

IPEwifi operates in bridging mode (means as LAN cable substitution), thus logger settings are similar to a direct LAN connection to the network connection point.

- ▶ Start IPEmotion
- ▶ Open an existing logger configuration or create a new one
- ▶ Highlight the logger in the left hand system structure
- ▶ Move to the configuration dialog (right hand lower area) with the **Data manager** tab, activate the check box **Update connection parameters** and click the **Configuration** button.
- ▶ Click to the **Medium selection** tab and activate the **LAN** check box.
- ▶ Activate the check box **Get IP address automatically**
- ▶ Confirm and close with the **OK** button.
- ▶ Transfer the current settings to the logger.

This settings enable the logger to receive its IP address through IPEwifi using DHCP services of the network server.

### Connecting IPEwifi and the logger with a LAN/PWR cable

- ▶ Connect IPEwifi with the logger as shown below.
- ▶ As soon as switched on, the green LED lights permanently.
- ▶ The yellow LED indicates a properly working LAN connection.
- ▶ The orange LED indicates a properly working WiFi connection.

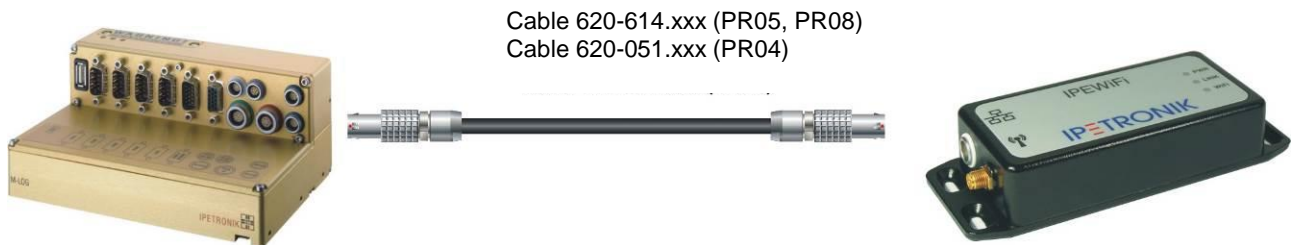

Depending on the logger settings under **COMgate switch-on condition** from the **System activated** tab, IPEwifi will be supplied with power by the logger

<b>Acquisition</b>	during the measurement,
<b>Postprocessing</b>	during data post processing, as soon as measurement is stopped, (follow-up time is running),
<b>Always</b>	as soon as the logger has started.



If the logger is not able to communicate with the network, although the settings are correct and the WiFi connection is steady (indicated by the orange LED), please check the entries of the log file (MEA\_xxxx.log).



As former M-LOG devices with port replicator PR05 have a 6-pin Ethernet connector, a direct connection (single cable) using the cable 620-614.xxx is not supported. Only devices with 7-pin Ethernet connector provide the lines (Pin 6 and 7) for the IPEwifi power supply.

### 10.1.4 GPS receiver

- ▶ GPS mouse for satellite positioning
- ▶ Connection to the serial logger interface
- ▶ Predefined settings of NMEA protocol configuration software



### 10.1.5 Bus isolator SAM-CAN-ISO

- ▶ High ohm connection of hardware to vehicle CAN
- ▶ Electrical isolation between vehicle bus and measurement system
- ▶ Connection with short stub
- ▶ Version "Hear only" to avoid unintended influencing of vehicle CAN



**SAM-ISO011-23A0**  
 Has e1 approval (Vehicle Type Approval VCA) for directly connecting with the CAN bus of public vehicles without restricting the type approval.

### 10.1.6 iMIC

- ▶ compact multifunction device (1.57 \* 1.44 \* 0.98 in) (40 \* 36,5 \* 25 mm)
- ▶ Voice recording with audio input
- ▶ good voice quality
- ▶ illuminated trigger button
- ▶ 3 status LEDs (green, yellow, multicolor)
- ▶ integrated buzzer



### Button (illuminated)

Triggering of data recording and/or voice recording via digital input 1.

### Status LEDs

**LED Yellow** Indicates the status of digital output 2 (LED is on if output is active.)

**LED Red** Indicates the status of digital output 3 (LED is on if output is active.)

### LED Multicolor

green Indicates the status of digital output 1 (green light)

blue Indicates the status of the yellow LED (blue light)

red Indicates the completed boot process. The excitation of the connected devices (at M-CAN or SIM-CAN socket) is switched-on.

### Buzzer

Acoustically indicates the status of digital output 3 (Buzzer ON if output is active).



*The specific functions of the digital inputs and outputs are defined in the measurement configuration (see [Standard functions](#) calculations, trigger, Use of digital inputs and outputs).*



The button functionality, as well as, the LEDs and buzzer functionality also depends on the wiring / PIN assignment. If another cable than 620-607.xxx is used, functionality can differ from the one described above.

**Cable 620-607.xxx**

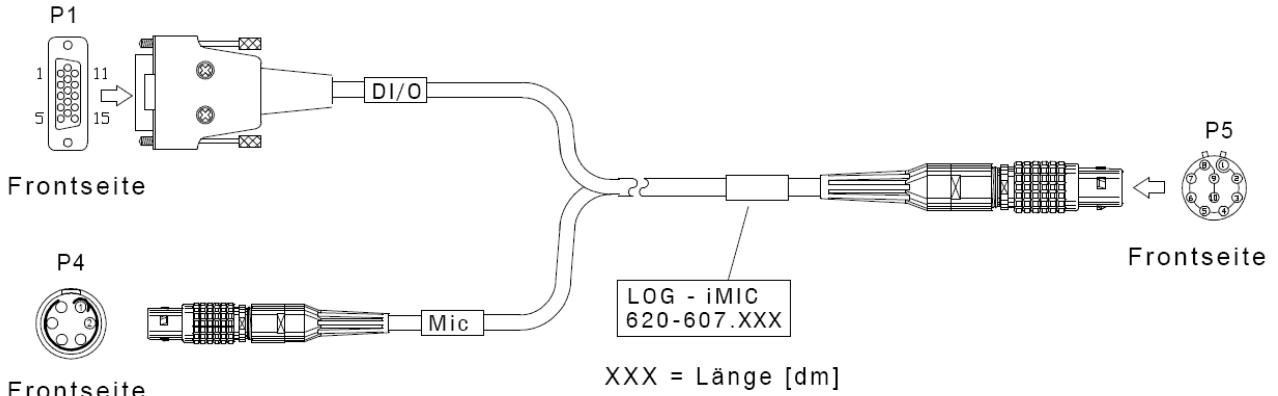

**PIN assignment cable 620-607.xxx**

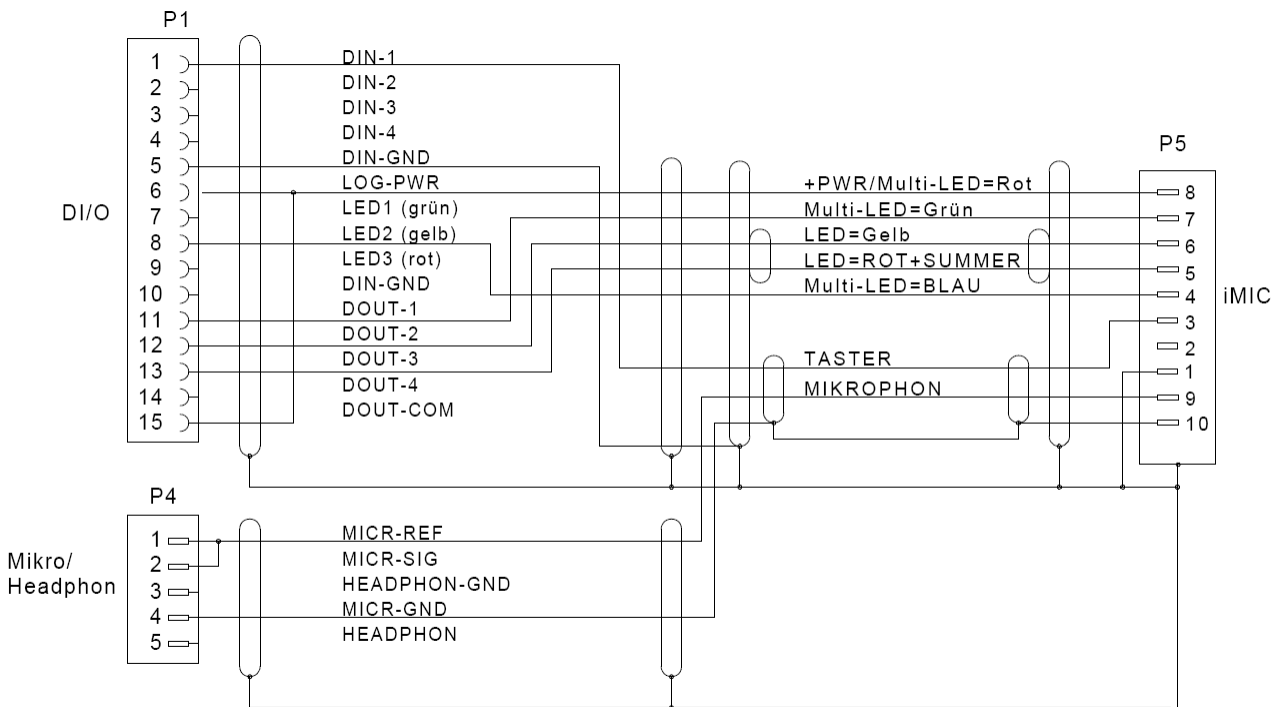

### 10.1.7 Mountings

#### Dovetail adapter



Adapter plate for mounting to the right M-LOG housing for connecting M devices without tools.

#### Fastening elements



2 fastening strips for mounting at the device bottom to screw M-LOG to an even surface.

#### Snap-in fastener



2 snap-in holders + 2 fastening strips for mounting at the device bottom to fix M-LOG at an even plate without tools.

#### Snap-in adapter

Mounting plate to use a snap-in fastener to fix M-LOG to plate without tools.

#### Suction pad holder for M-VIEWfleet / M-VIEWgraph

Suction pad holder with pump for fixing driver display on smooth surfaces e.g. at windshield.



Figures are subject to change!



*Due to safety reasons, the bottom of the display housing must rest on an underlay (e.g. instrument panel). Avoid a free mounting and do not use the suction pad holder alone for drive tests.*

## 10.2 CAN FD and FlexRay Satellites

On the ETH Interface you can create a satellite interface for FlexRay and CAN FD satellites.

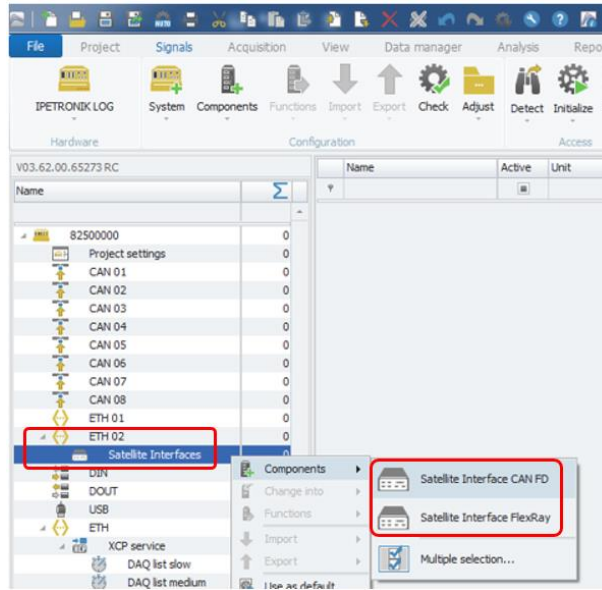

ETH2 interface is the recommended one, as the IP-address range first directly to the IP-address rangen of the extenders.

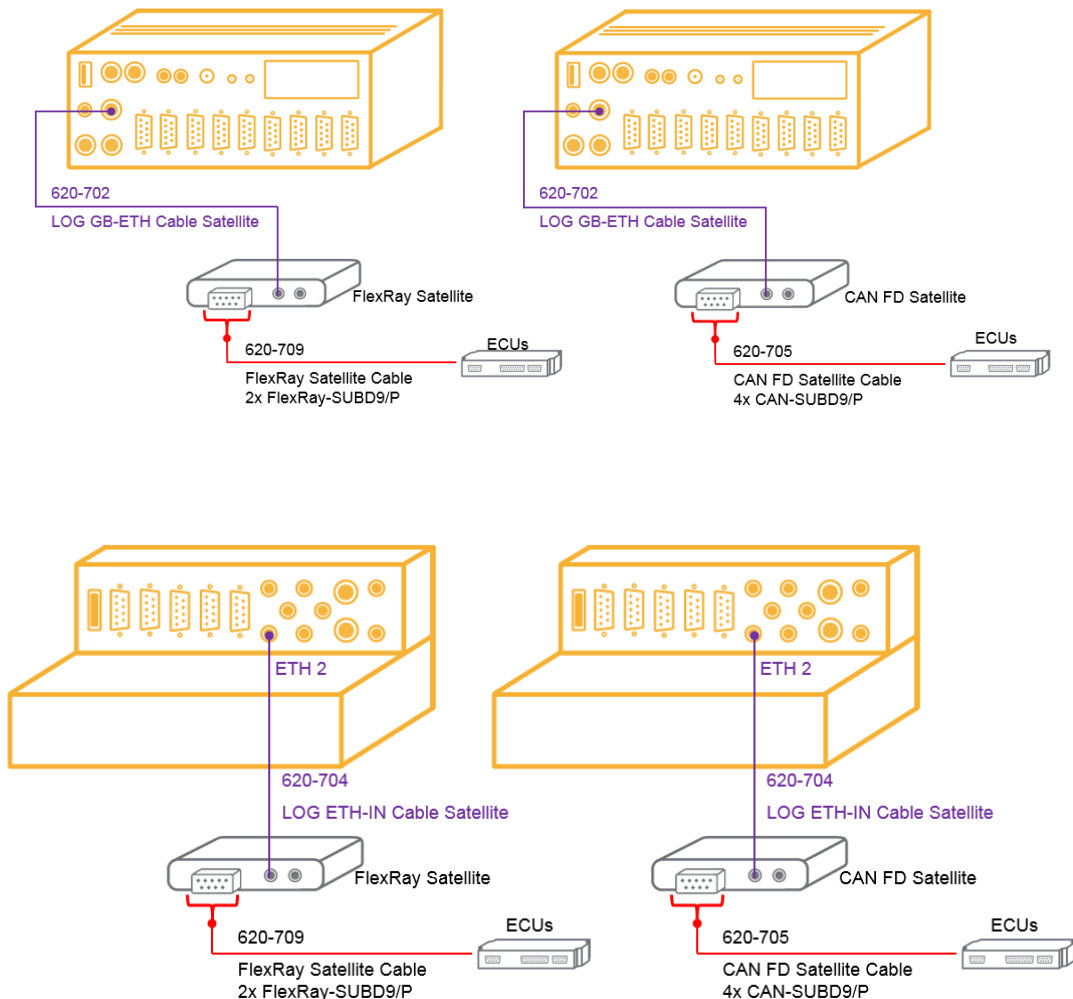

# 11 Appendix

## 11.1 Cable connection and Pin assignment

### 11.1.1 M-LOG port replicators

#### Port replicator PR05 (4x Sub D 9, PWR-IN/REM Lemo 1B 6 pin)

##### Internal circuits PR05

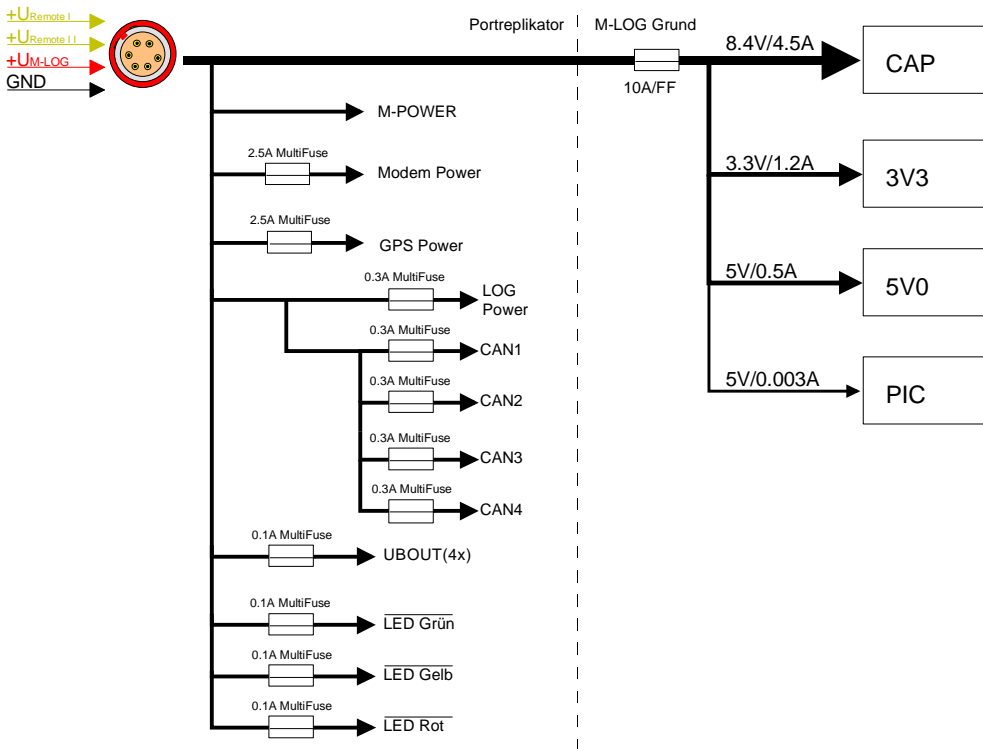

##### Cable reference PR05

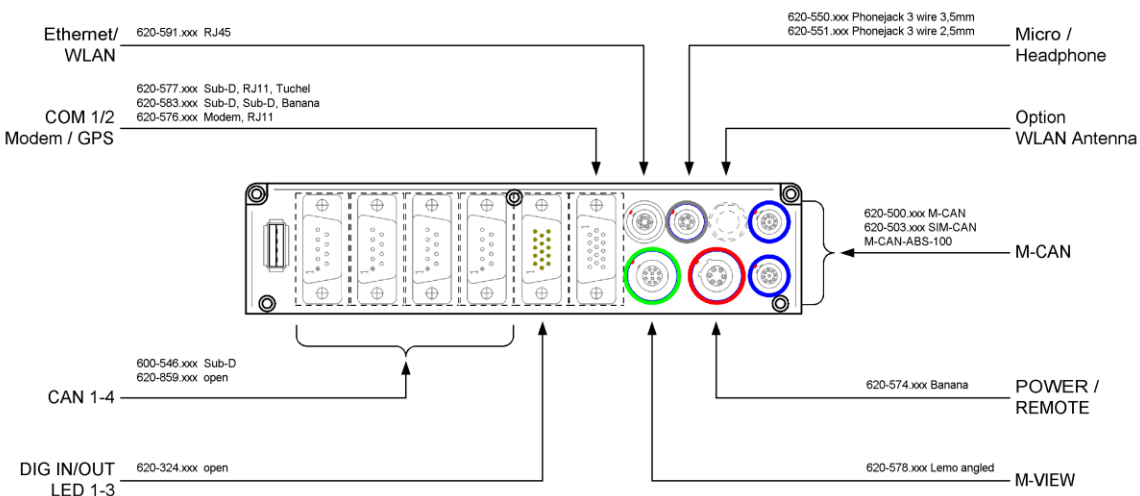



### PIN assignment PR05

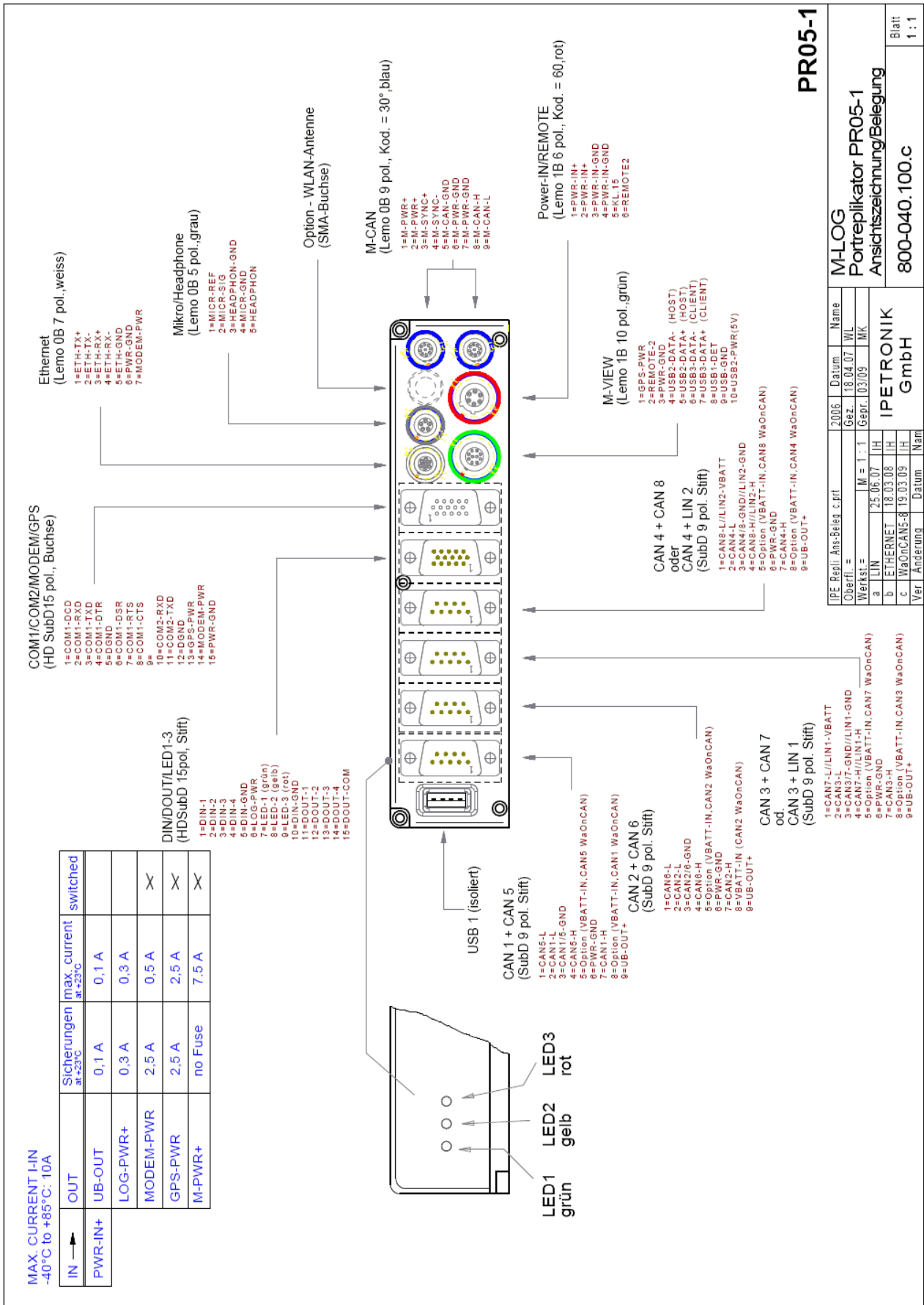

IN	OUT	Sicherungen	max. current	switched
PWR-IN+	UB-OUT	0.1 A	0.1 A	
	LOG-PWR+	0.3 A	0.3 A	
	MODEM-PWR	2.5 A	0.5 A	X
	GPS-PWR	2.5 A	2.5 A	X
	M-PWR+	no Fuse	7.5 A	X

**PR05-1**

**MLOG**  
Portreplikator PR05-1  
Ansichtszeichnung/Belegung  
800-040.100.c

IPETRONIK	GmbH
Ver	Änderung
Datum	19.03.09
Man	IH
Werkst	M = 1 : 1
Gez	18.04.07
WL	MK
Datum	2006
Name	

# Port replicator PR08 (4x Sub D 9, ETH, PWR-IN/REM Lemo 1B 6 pin) PIN assignment PR08

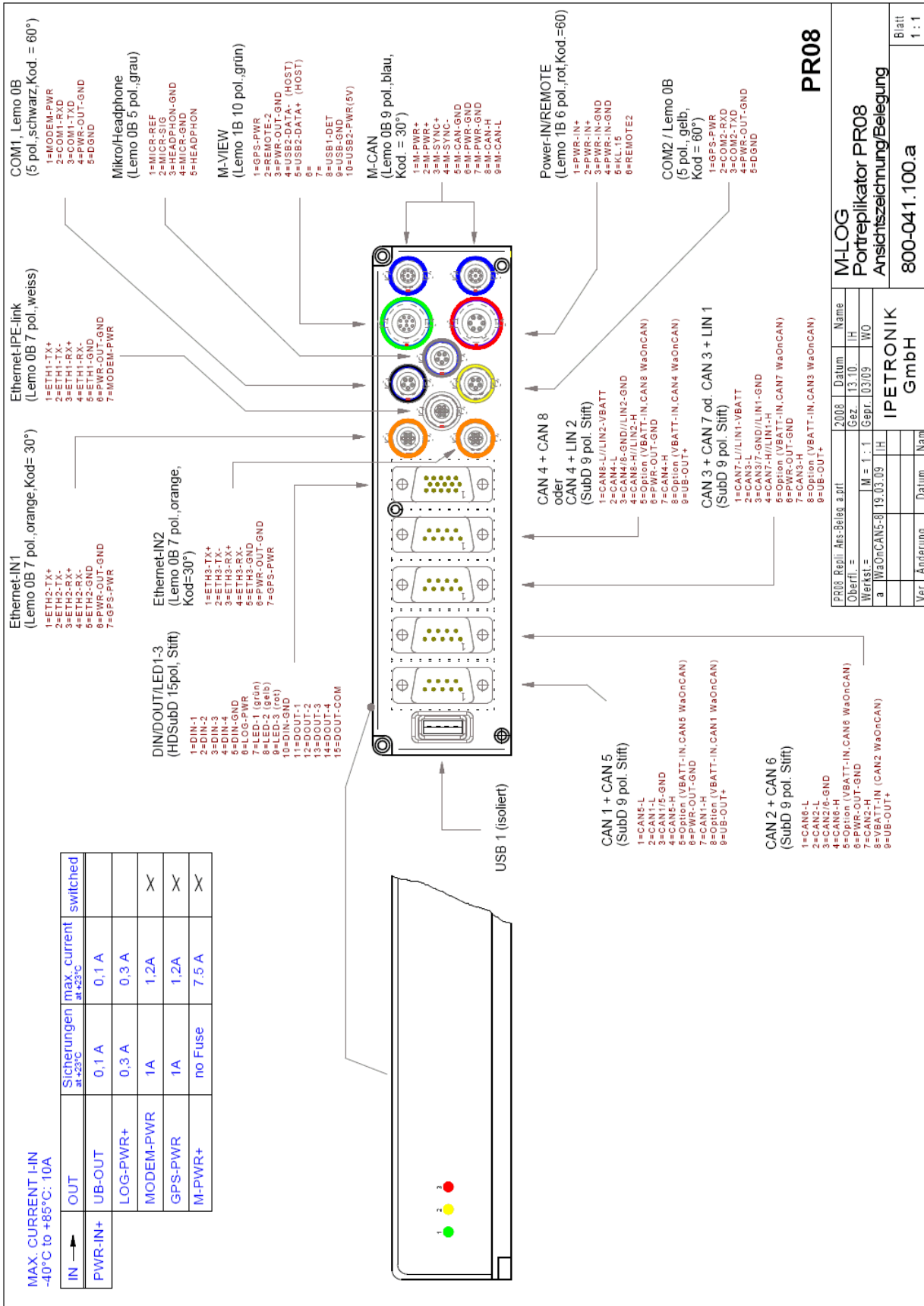

### 11.1.2 FLEETlog2-01

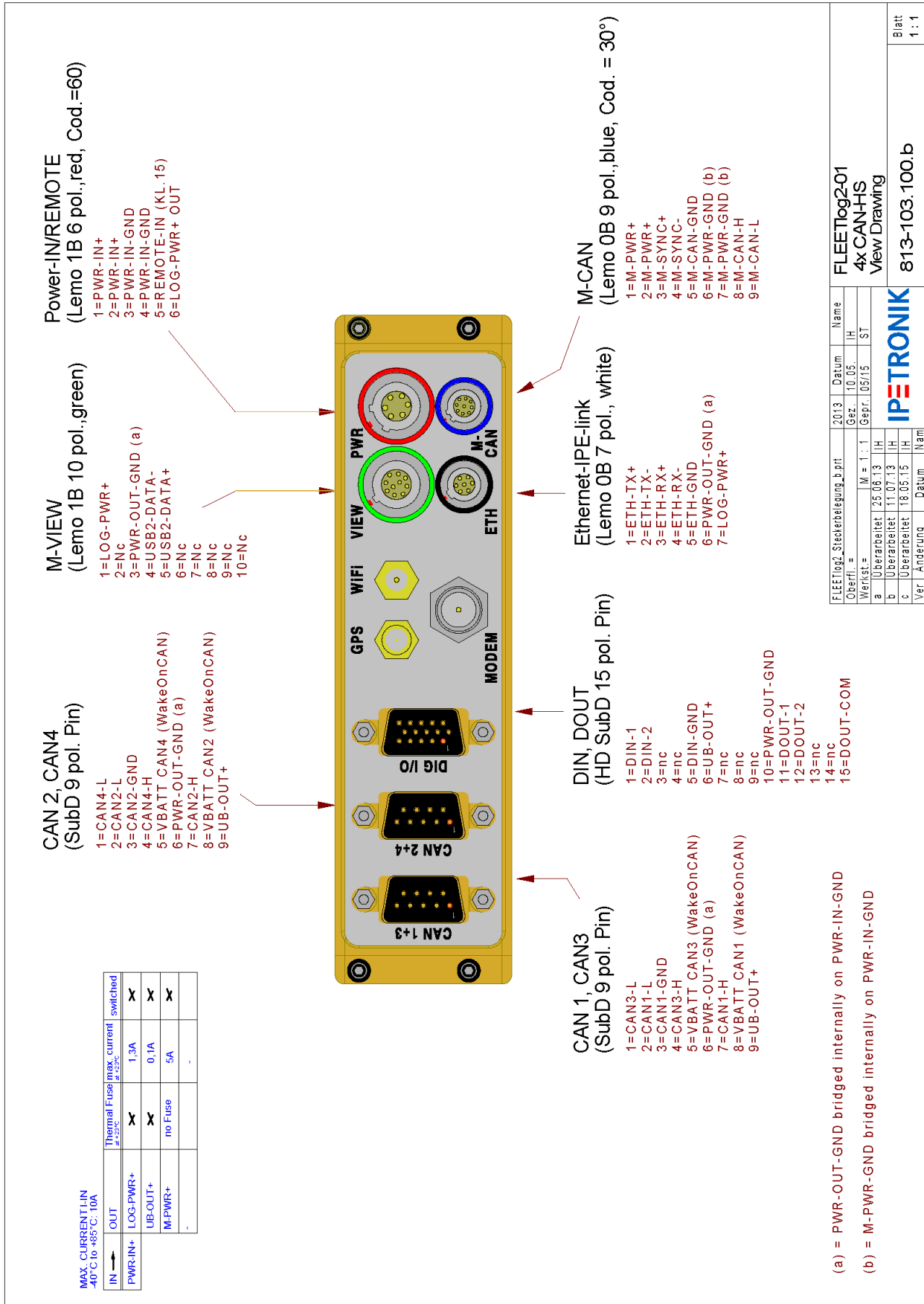

**MAX. CURRENT IN**  
-40°C to +85°C, 10A

IN →	OUT	Thermal Fuse at 125°C	max. current at 25°C	switched
PWR-IN+	LOG-PWR+	X	1,3A	X
UB-OUT+	M-PWR+	X	0,1A	X
		no Fuse	5A	X

(a) = PWR-OUT-GND bridged internally on PWR-IN-GND  
 (b) = M-PWR-GND bridged internally on PWR-IN-GND

FLEETlog2_Steckbelegung_0.ppt	2013	Datum	Name
Oberfl. =	M = 1 : 1	Gez. 10.05.15	IH
Verkt. =		Gepr. 05/15	ST
a	Überarbeitet: 25.06.13	IH	
b	Überarbeitet: 11.07.13	IH	
c	Überarbeitet: 18.05.15	IH	
Ver. Änderung	Datum	Inam	

FLEETlog2-01  
4x CAN-HS  
View Drawing  
813-103.100.b  
Blatt 1 : 1

### 11.1.3 FLEETlog2-03

IN	OUT	Thermal Fuse max. current at +25°C	switched
PWR-IN+	LOG-PWR+	1,3A	X
UB-OUT+		0,1A	X
M-PWR+	no Fuse	5A	X

**M-VIEW**  
(Lemo 1B 10 pol., green)

- 1=VIEW PWR +
- 2=NC
- 3=VIEW PWR - (a)
- 4=VIEW DATA-
- 5=VIEW DATA+
- 6=NC
- 7=NC
- 8=NC
- 9=NC
- 10=NC

**Power-IN/REMOTE**  
(Lemo 1B 6 pol., red, Cod.=60)

- 1=PWR IN+
- 2=PWR IN+
- 3=PWR IN-GND
- 4=PWR IN-GND
- 5=REMOTE IN (KL.15)
- 6=LOG-PWR OUT +

**CAN1-4/DIG I/O**  
(SubD 25pol, Pin)

- 1=DIG IN 1
- 2=DIG IN 2
- 3=DIG IN GND
- 4=CAN4 GND
- 5=CAN4 L
- 6=CAN4 H
- 7=CAN4 VBATT
- 8=CAN3 GND
- 9=CAN3 L
- 10=CAN3 H
- 11=CAN3 VBATT
- 12=PWR OUT - (a)
- 13=PWR OUT +
- 14=DIG OUT 1
- 15=DIG OUT 2
- 16=DIG OUT COM
- 17=CAN2-GND
- 18=CAN2 L
- 19=CAN2 H
- 20=CAN2 VBATT
- 21=CAN1 GND
- 22=CAN1 L
- 23=CAN1 H
- 24=CAN1 VBATT
- 25=LOG-PWR OUT +

**Ethernet-IPe-link**  
(Lemo 0B 7 pol., white)

- 1=LAN TX+
- 2=LAN TX-
- 3=LAN RX+
- 4=LAN RX-
- 5=LAN GND
- 6=PWR-OUT - (a)
- 7=LOG PWR OUT +

**M-CAN**  
(Lemo 0B 9 pol., blue, Cod. = 30°)

- 1=M-PWR OUT +
- 2=M-PWR OUT +
- 3=NC (M-SYNC+)
- 4=NC (M-SYNC-)
- 5=M-CAN-GND
- 6=M-PWR OUT - (b)
- 7=M-PWR OUT - (b)
- 8=M-CAN H
- 9=M-CAN L

(a) = PWR-OUT-GND bridged internally on PWR-IN-GND  
(b) = M-PWR-GND bridged internally on PWR-IN-GND

FLEETlog2_SubD25_Steckerbelegung.gbr	2015	Datum	Name
Oberfl. =	IM = 1 : 1	Gez. 18.02.15	IH
Werkst. =			ST
a PWR-Bereich	26.03.15	IH	
b Z.-Nr. geänd.	18.05.15	IH	
Ver.	Änderung	Datum	Nam
			<b>IPETRONIK</b>
			FLEETlog2-03 (SubD25)
			4x CAN-HS
			View Drawing
			813-303.100.b
			Blatt 1.1

### 11.1.4 FLEETlog

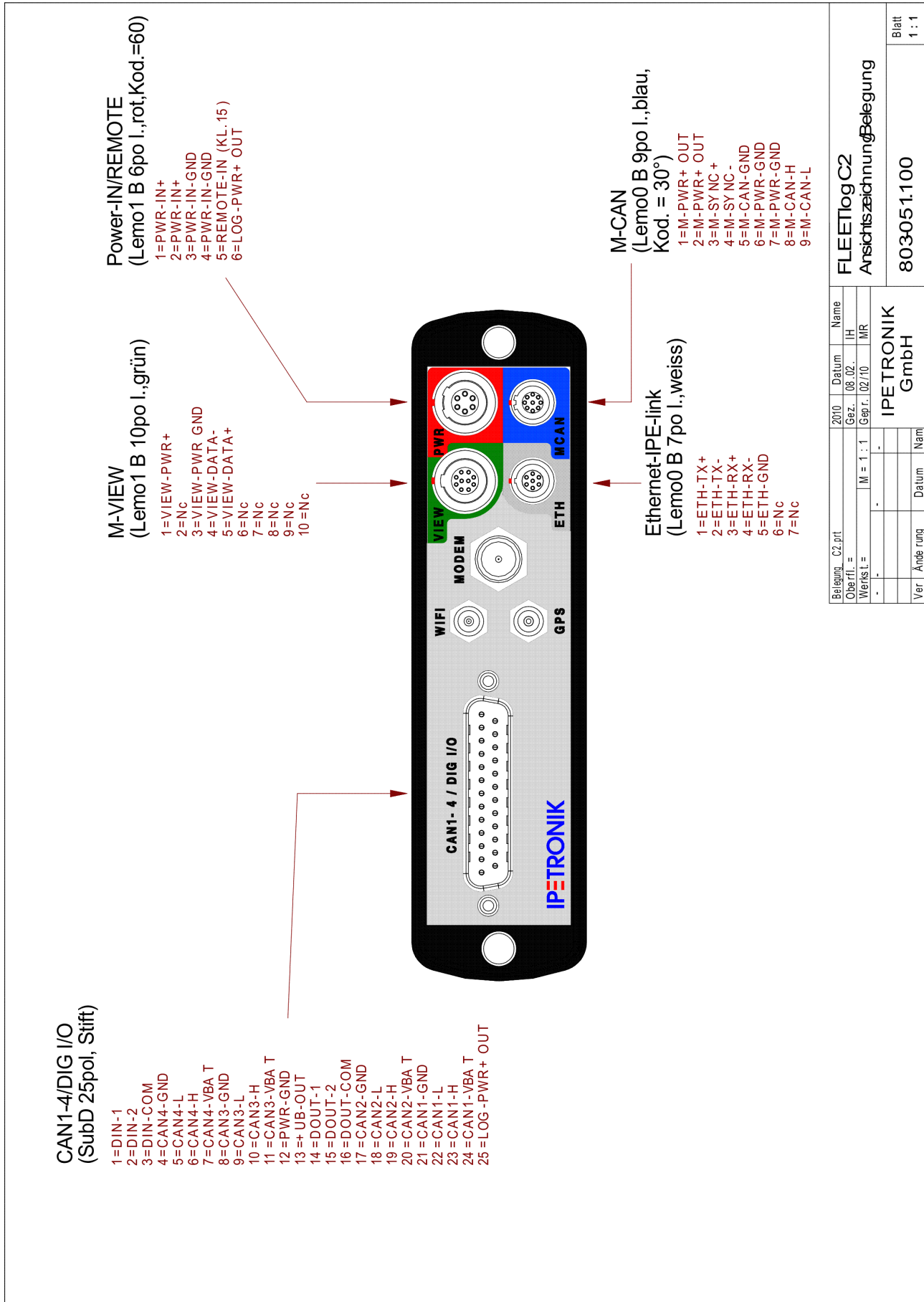

Belegung C2 prt.		2010	Datum	Name
Oberfl.	=	Gez.	08.02.	IH
Werkst.	=	M = 1 : 1	Gepr.	02/10
				M/R
Ver.	Änderung	Datum	Name	
			IPETRONIK GmbH	
FLEETlog C2			Ansichtszeichnung	
803051.100			Belegung	
			Blatt 1 : 1	

### 11.1.5 IPElog

**MAX. CURRENT I-IN**  
-40°C to +85°C: 10A

IN →	OUT	Thermal Fuse at +23°C	imax at +23°C	switched
PWR-IN+	LOG-PWR+	X	1,3A	X
	MODEM-PWR+	X	1,3A	X
	M-PWR+	no Fuse	5A	X
	ETH-PWR+	X	1,3A	X
	USB 1 PWR+	X	0,5A	X
	USB 2 PWR+	X	0,5A	X

**M-CAN**  
(Lemo 09 pol.,blau,  
Kod. = 30°)

- 1=M-PWR+
- 2=M-PWR+
- 3=nc
- 4=nc
- 5=M-CAN1-GND
- 6=M-PWR-GND (c)
- 7=M-CAN1-H
- 8=M-CAN1-L
- 9=M-CAN1-L

**Ethernet-IPe-link**  
(Lemo 08 7 pol.,weiss)

- 1=ETH-link-TX+
- 2=ETH-link-TX-
- 3=ETH-link-RX+
- 4=ETH-link-RX-
- 5=ETH-link-GND
- 6=PWR-OUT-GND (b)
- 7=MODEM-PWR+

**Ethernet-IN1**  
(Lemo 08 7 pol.,orange,Kod= 30°)

- 1=ETH1-TX+
- 2=ETH1-TX-
- 3=ETH1-RX+
- 4=ETH1-RX-
- 5=ETH1-GND
- 6=PWR-OUT-GND (b)
- 7=ETH-PWR+

**Ethernet-IN2**  
(Lemo 08 7 pol.,orange,  
Kod=30°)

- 1=ETH2-TX+
- 2=ETH2-TX-
- 3=ETH2-RX+
- 4=ETH2-RX-
- 5=ETH2-GND
- 6=PWR-OUT-GND (b)
- 7=ETH-PWR+

**M-VIEW**  
(Lemo 1B 10 pol.,grün)

- 1=LOG-PWR+
- 2=PWR-OUT-GND (b)
- 3=USB2-DATA+
- 4=USB2-DATA-
- 5=USB2-DATA+
- 6=nc
- 7=nc
- 8=nc
- 9=USB-GND (a)
- 10=USB2-PWR+ (5V)

**USB 2**  
(Lemo 1B 5 pol.,grau)

- 1=USB2-PWR+
- 2=USB2-DATA+
- 3=USB2-DATA-
- 4=SHIELD
- 5=USB-GND (a)

**Power-IN/REMOTE**  
(Lemo 1B 6 pol.,rot,Kod.=60)

- 1=PWR-IN+
- 2=PWR-IN+
- 3=PWR-IN-GND
- 4=PWR-IN-GND
- 5=REMOTE
- 6=LOG-PWR+ (M-UPS)

**DIN/OUT/LED1-3**  
(HDSUBD 15pol, Stiff)

- 1=DIN-1
- 2=DIN-2
- 3=DIN-3
- 4=DIN-GND (d)
- 5=DIN-GND (d)
- 6=LOG-PWR+
- 7=LED-1 (grün)
- 8=LED-2 (gelb)
- 9=LED-3 (rot)
- 10=DIN-GND (d)
- 11=DDOUT-1
- 12=DDOUT-2
- 13=DDOUT-3
- 14=DDOUT-4
- 15=DDOUT-COM

**CAN 1 ... CAN6 + CAN 7 ... CAN12**  
(SubD 9 pol. Stiff)

- 1=CAN7-L ... CAN12L
- 2=CAN1-L ... CAN6-L
- 3=CAN7-H ... CAN12-H
- 4=CAN1-H ... CAN6-H
- 5=nc
- 6=CAN7-GND ...CAN12-GND
- 7=CAN1-H ... CAN6-H
- 8=nc
- 9=nc

(a) = USB-GND intern auf PWR-IN-GND gedrückt  
 (b) = PWR-OUT-GND intern auf PWR-IN-GND gedrückt  
 (c) = M-PWR-GND intern auf PWR-IN-GND gedrückt  
 (d) = DIN-GND intern auf PWR-IN-GND gedrückt

IPemotion PlugIn IPETRONIK-LOG

IPETRONIK GmbH & Co. KG

ipetronik.com

158/ 173

IPElog		Ausführung C1		Belegung	
IPeLog_C1_Ans-Baleg_c.prt	2012	Datum	Name		
Oberfl. =	M = 1 : 1	Gez. 12.10.11	IH		
a	Überarbeit.	05.11.12	IH	IPETRONIK	
b	Überarbeit.	07.11.12	IH	GmbH	
c	DIGI/O-Pin10	04.04.13	IH	809-003.101.b	
Ver. / Änderung	Datum	Name		Blatt	
				1 : 1	

### 11.1.6 IPElog2-01 (16 CAN)

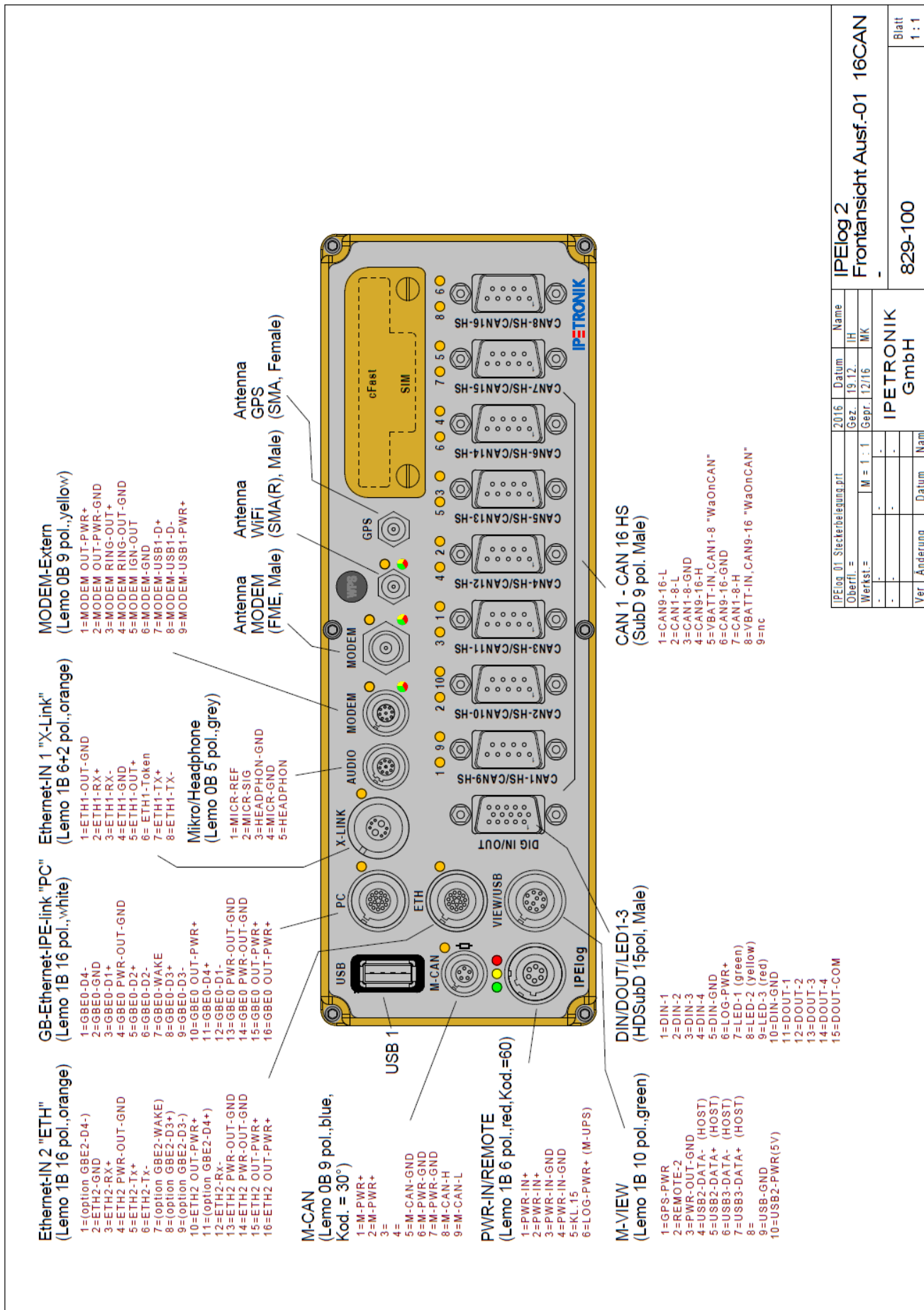

**Antenna MODEM (FME, Male) (SMA(R), Male)**

**Antenna MODEM WIFI (SMA(R), Male)**

**Antenna GPS (SMA, Female)**

**Mikro/Headphone**  
(Lemo 0B 5 pol., grey)

- 1=MICR-REF
- 2=MICR-SIG
- 3=HEADPHON-GND
- 4=MICR-GND
- 5=HEADPHON

**PC**

**ETH**

**VIEW/USB**

**IPeLog**

**USB 1**

**M-CAN**

**GPS**

**MODEM**

**AUDIO**

**X-LINK**

**DIG IN/OUT**

**CAN1-HS/CAN9-HS**

**CAN2-HS/CAN10-HS**

**CAN3-HS/CAN11-HS**

**CAN4-HS/CAN12-HS**

**CAN5-HS/CAN13-HS**

**CAN6-HS/CAN14-HS**

**CAN7-HS/CAN15-HS**

**CAN8-HS/CAN16-HS**

**cFast**

**SIM**

IPeLog_01 Steckkartelegung.gri	2016	Datum	Name
Oberfl. =	Gez. 19.12.	IH	
Wertst. =	M = 1 : 1	Gepr. 12/16	MK
Ver. Änderung		Datum	Nam

**IPElog 2**

**Frontansicht Ausf.-01 16CAN**

**829-100**

**IPETRONIK GmbH**

Blatt 1 : 1

### 11.1.7 IPElog2-02 (10 CAN, 6 LIN)

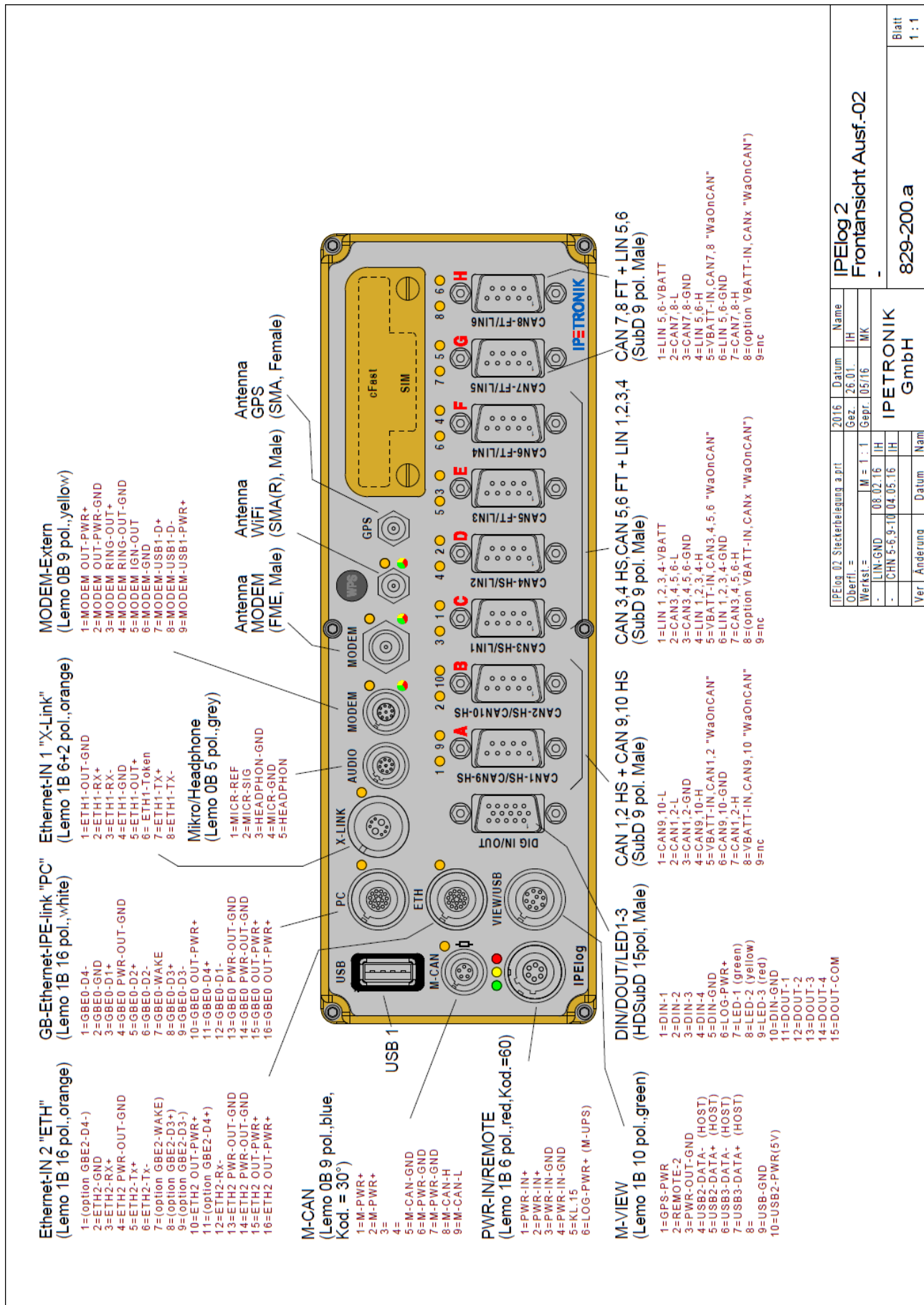



## 11.2 Starting up

### 11.2.1 Overview Configuration & Measurement

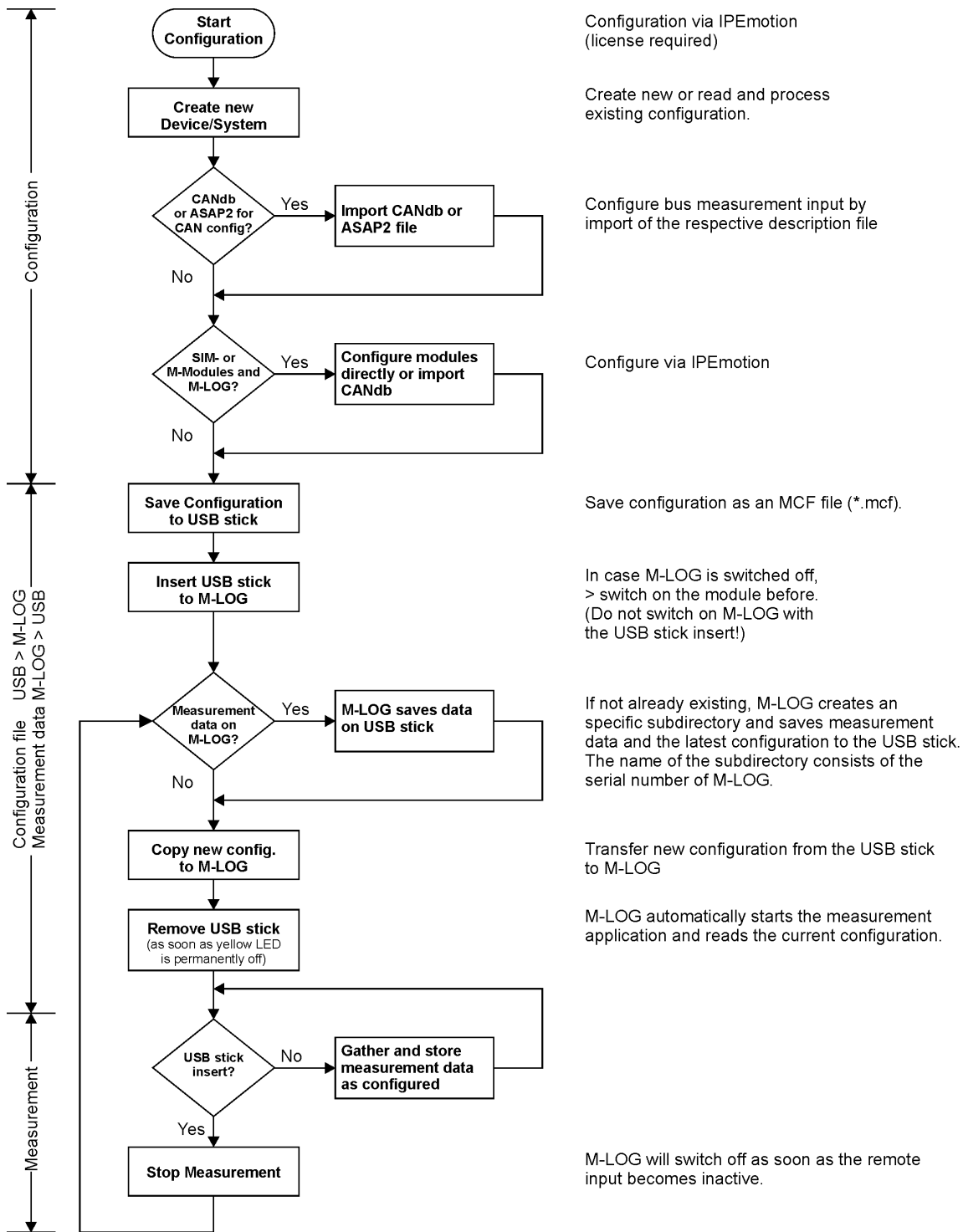

### 11.2.2 Flow chart of the measuring process

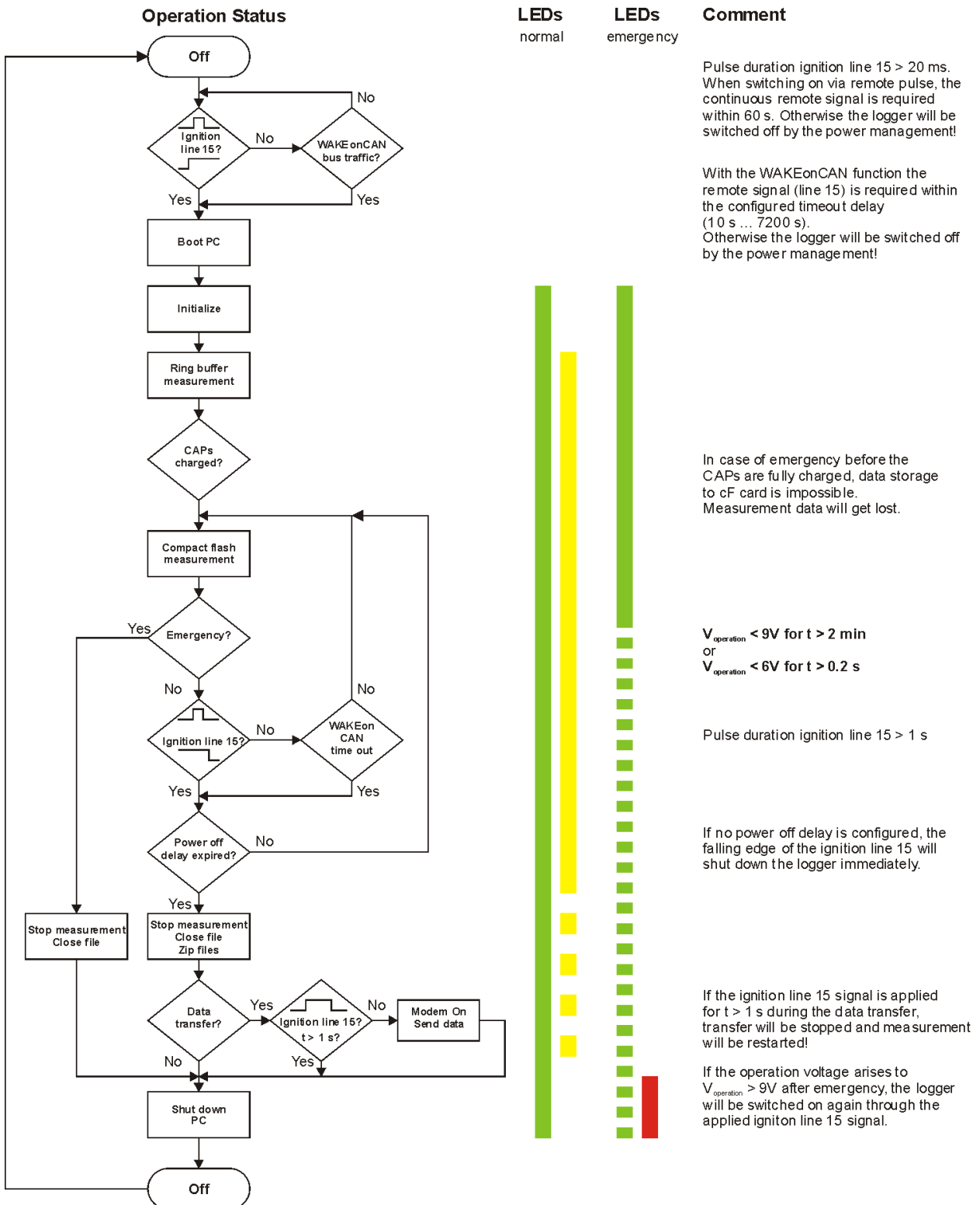

## 11.3 Practical examples

### 11.3.1 Calculating memory footprint

The memory footprint per storage group results from the following data

- ▶ Memory footprint of acquisition channels +
- ▶ Memory footprint of time channel (relative and absolute time channel) +
- ▶ Memory footprint of header (description file)

#### **Memory footprint of acquisition channels**

Acqu. duration [s] x storage rate [1/s] x channel count x 2 Byte = memory footprint in Byte

Memory footprint in Byte / 1024 = memory footprint in kByte

#### **Memory footprint of time channel (IPE:Clock = relative time channel)**

Acqu. duration [s] x storage rate [1/s] x 4 Byte = memory footprint in Byte

Memory footprint in Byte / 1024 = memory footprint in kByte

Do not mix the time channel (relative) with the time stamp channel (absolute = Date, time). The time stamp channel is only recorded if activated in storage group dialog.

#### **Memory footprint of header file**

The memory footprint of the header file depends on the size of acquisition configuration (channel count, sampling rate, different data formats, ...) and cannot be defined by a general formula. The size of the header file is usually much smaller so that it can be neglected. Exceptions are short acquisitions or acquisitions with many channels at low storage rate (< 1 Hz).

### 11.3.2 Linear signal scaling

The conversion of a raw value (binary value, e.g. in a CAN message) into a physical value (value with unit) is effected with the scaling. IPETRONIK offers the scaling calculator and supports linear scaling with the line equation as factor/offset or 2 point scaling.

The scaling of a voltage or current signal (sensor output) into a corresponding physical or percentage value is effected in the same way. The following examples show the connections.

#### Mathematical basics for the linear equation

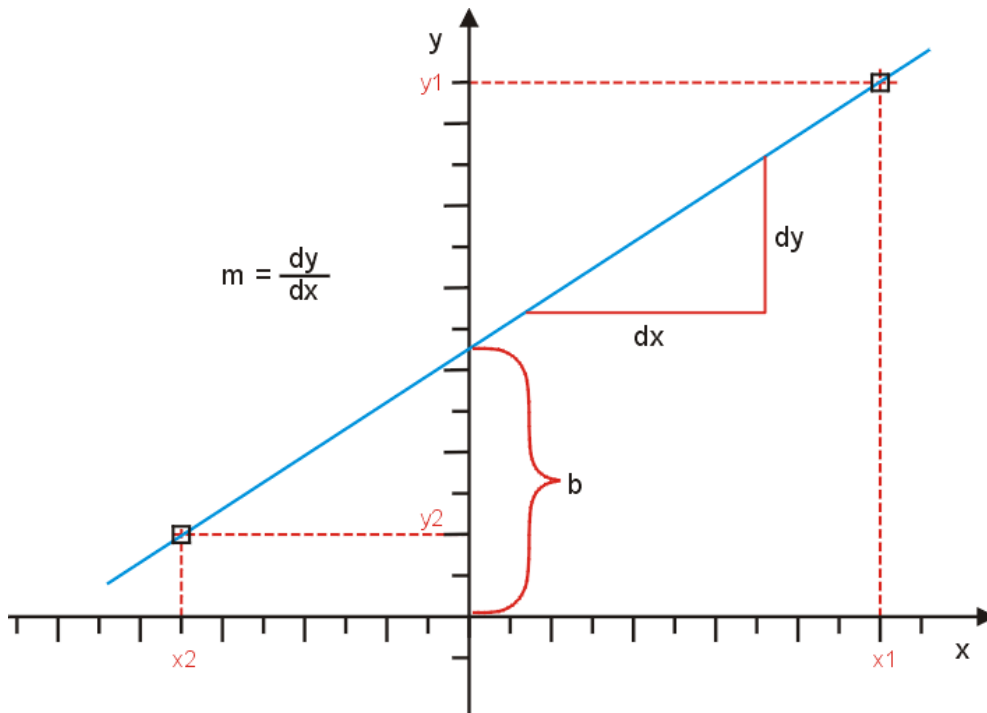

#### Point gradient form

$$y = m * x + b$$

$$b = y - m * x$$

$m$  = Gradient (gain)  
 $b$  = constant (offset)

#### Two points form

$$m = dy / dx$$

$$m = (y1 - y2) / (x1 - x2)$$

$m$  = Gradient (gain)

#### Calculation and explanation

1. The linear equation  $y = m * x + b$  shows the mathematical connection.
2. Calculate the  $m$  gradient within any input range (signal) and the related output range (physical value).
3. Calculate the offset  $b$  by using the  $x$  and  $y$  values for a known point.
4. Calculate, if required, further  $y$  values by using the corresponding  $x$  values and the equation, e.g. for calculating the physical values for another input range (Channel min, max).

### Example pressure sensor

A pressure sensor has an output signal of -0.5 to 4.5 V in the acquisition range 0 ... 20 bar. The voltage signal is converted to the physical value with the linear scaling.

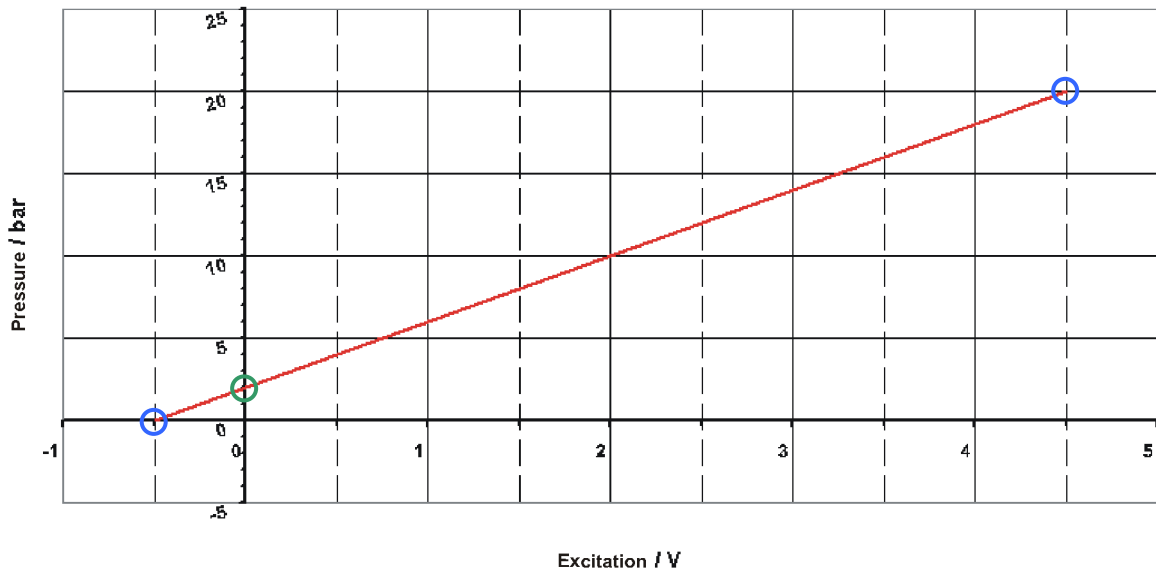

x1	x2	y1	y2	m	b'	b
4.5	-0.5	20	0	4	2	2

### Example CAN raw value in the Word unsigned format als temperature

A temperature signal is a CAN message in the Word unsigned format. The value range of 0... 65535 (16 Bit) corresponds to a temperature range of -50 °C ... +200 °C.



Please note that the output range has an offset of -50 °C. This must be respected at calculating: ( $b'$  = Offset without output offset,  $b$  = Offset + output offset).

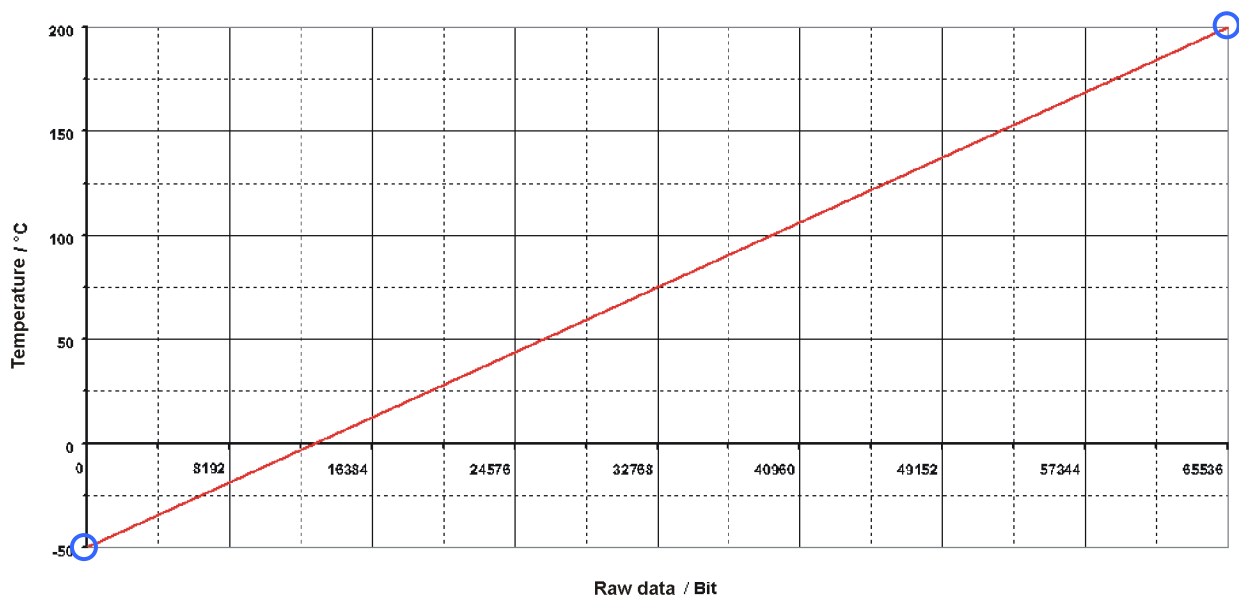

x1	x2	y1	y2	m	b'	b
65535	0	200	-50	0.0038147	0	-50

### Example CAN raw value in the Word signed format as temperature

A temperature signal is a CAN message in the Word signed format. The value range of -32768... 0 ... 32767 (16 Bit) corresponds to a temperature range of -50 °C ... +200 °C.



Please note that the output range has an offset of -50 °C. This must be respected at calculating: ( $b'$  = Offset without output offset,  $b$  = Offset + output offset).

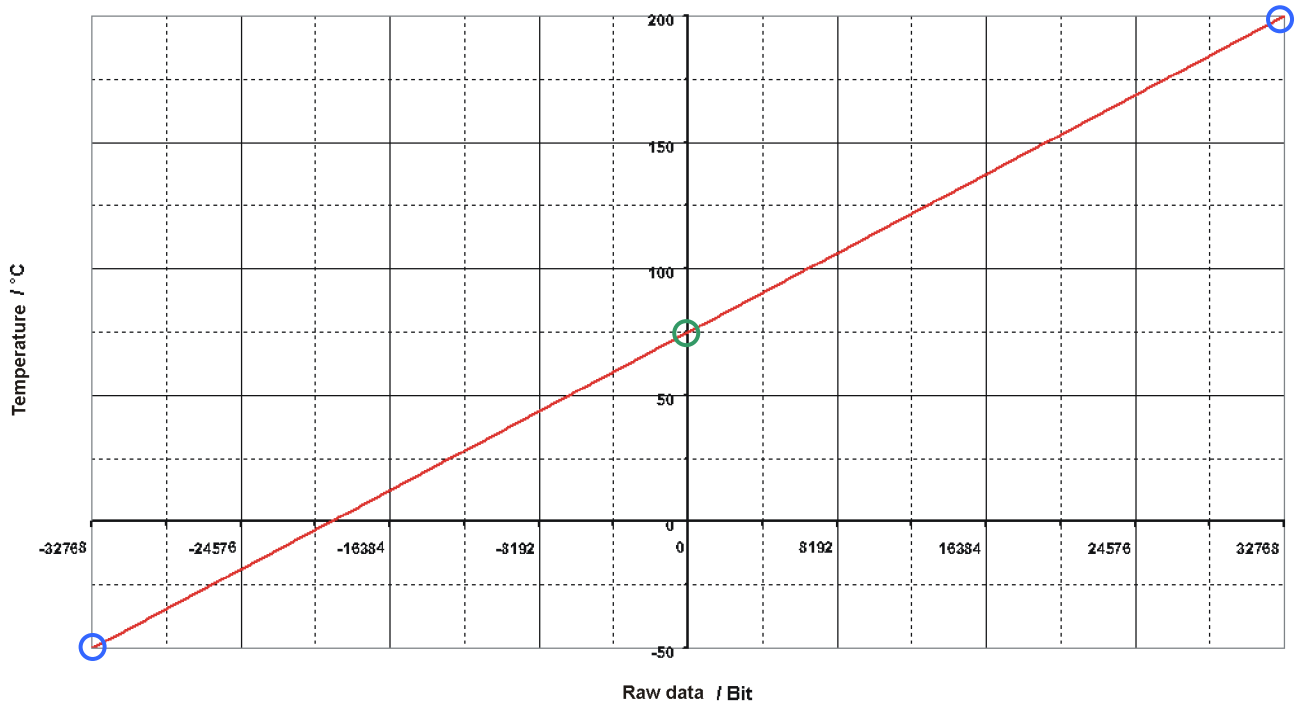

x1	x2	y1	y2	m	b'	b
32767	-32768	200	-50	0.0038147	125.0019	75.0019

## 11.4 Status messages

### 11.4.1 Most important status messages

Following message types are defined:

**I Information      W Warning      E Error      D Debug**

**Type number: xxx-xxx-xxxx**

Number corresponds to the number of the type plate of M-LOG (entry in hw\_descr.xml).

#### **Wait max. 3min for write permission (power good)**

M-LOG waits until CAPs are loaded (status message "Power good" from PIC). If status is "Power good", data is written to flash. If this status is not reached, (PIC) switches off M-LOG after 3 min.

#### **Power good**

Message (from PIC) that CAPs are loaded.

#### **Debounce remote signal 1000 ms**

Remote signal must be on at least for 1 s to reach "ON" status. (Debouncing of remote signal)

Remote signal is detected as such if excitation > 6.5 V at PIN terminal:15 of PWR-IN/REM socket.

#### **Watchdog active**

PIC transfers control of M-LOG to TESTdrive.

Function: Testdrive cyclically describes a storage range in Powermanagement (PIC) (toggling bit). If this toggling fails for more than two minutes, M-LOG is switched off by Powermanagement (PIC).

#### **Free disk space: xxx/xxx**

Indicates the available total memory space. TestDrive 3.09 shows a "Free disk space: xxxx" at the left bottom display window. It shows the available space for data storage (40% of total memory space). Initially, this value fluctuates intensively but stabilizes with a longer acquisition because it is recalculated permanently.

#### **Time left: xx xx:xx:xx**

Display bottom left in monitor window. Meaning: d hh:mm:ss

#### **Power bad**

If excitation is too low, status is "Power bad".

Info: This message is not concerned with CAPs contrary to "Power good" message.

#### **Can't initialize communication mediums**

Dev\_conf.xml is not included in Config, i.e. no data transfer activated.

#### **Shutdown in 55 min**

If data postprocessing (zipping, establishing, data transferring, data sending, etc.) is not completed within 55 min, Testdrive shuts down and data remains on logger.

#### **Emergency shutdown in 60 min**

Logger is unconditionally shut down after 60 min. Powermanagement of M-LOG controls the device.

**Time left: xx xx:xx:xx**

Display bottom left in monitor window. Meaning: d hh:mm:ss

**Power bad**

If excitation is too low, status is "Power bad".

Info: This message is not concerned with CAPs contrary to "Power good" message.

**Can't initialize communication mediums**

Dev\_conf.xml is not included in Config, i.e. no data transfer activated.

**Shutdown in 55 min**

If data postprocessing (zipping, establishing, data transferring, data sending, etc.) is not completed within 55 min, Testdrive shuts down and data remains on logger.

**Emergency shutdown in 60 min**

Logger is unconditionally shut down after 60 min. Powermanagement of M-LOG controls the device.

**11.4.2 Warning and error messages after program update****Program options without license**

TESTdrive Version 3.17 includes a license software to check the use of logger / TESTdrive options. This requires sending new license keys to the logger.

After a TESTdrive program update, potential warning messages can indicate locked options. TESTdrive checks if used functions are really unlocked on the logger. Following warning is written into log file if e.g. all inputs of a card with 4 CAN inputs is used but only 2 are unlocked.

**01.04.2009 14:11:45 W CAN1 : Upper limit of licenced CAN interfaces reached. Max= 2**

Please contact the sales team at +49 7221 / 9922 – 222 to assist you with warning and error messages, as well as, licensing.



*TESTdrive V03.22 deactivates the non-licensed functionality and warns with the red status LED (temporarily at acquisition start). Depending on the missing license, acquisitions are limited (e.g. possible calculations but no classification) or disabled (e.g. at missing license for interface).*

*If an extender is used at the logger, an additional license for the extender is required!*

The system shows the following warning if an extender is used with a non-licensed CCP protocol:

**16.02.2011 15:36:01 E Extender.80200011: Error reading XML-Buffer at line 11**



## 11.5 Description of TESTdrive files

TESTdrive provides the measurement files as zip archives. TESTdrive creates separate zip files for every acquisition:

MEA\_xxxx.zip (Acquisition data + header file + current configuration)

LOG\_xxxx.zip (Protocol file for data acquisition)

A data set of an acquisition always includes a header file (AABBCCC.DAT), at least one acquisition file in DIAdem format, as well as, the corresponding acquisition configuration (e.g. IPEmotion.isf).

The names of the single acquisition files are generated according to the **AABBCCC.DDD** structure:

<b>AA</b>	=	Data type
<b>BB</b>	=	Consecutive number allocated based on all data types used with the configuration
<b>CCCC</b>	=	Consecutive number of an acquisition
<b>DDD</b>	=	File extension

**AA** data type indicates the type of data:

<b>DO</b>	=	<b>Data Online</b> (storage group with time channel)
<b>PM</b>	=	<b>Post Mortem</b> data of a ring buffer group (storage group with time channel)
<b>CO</b>	=	<b>(C) Classification Online</b> (storage group with statistic data, without time reference)
<b>A0</b>	=	<b>Audio Online</b>
<b>V0</b>	=	<b>Video Online</b>
<b>J</b>	=	<b>Job data</b> = Diagnostic data
<b>ST</b>	=	Min-Max list
<b>TBQS, T</b>	=	CAN/LIN traffic acquisition (during or after boot process)
<b>MV</b>	=	Maneuver recording

The consecutive **BB** number clearly assigns data within one data type. Several storage groups for instance can be detected with real-time data, which are distinguished from each other by this number.

The consecutive **CCCC** number differentiates between single acquisitions. Each acquisition is therefore clearly defined.

The **DDD** file extension defines the data format as follows:

<b>DAT</b>	=	DIAdem header file
<b>T64</b>	=	DIAdem time channel with 64 bit resolution
<b>W8</b>	=	DIAdem data with 8 bit unsigned (BYTE)
<b>W16</b>	=	DIAdem data with 16 bit unsigned (WORD)
<b>W32</b>	=	DIAdem data with 32 bit unsigned (WORD)
<b>I16</b>	=	DIAdem data with 16 bit signed (INTEGER)
<b>I32</b>	=	DIAdem data with 32 bit signed (INTEGER)
<b>R32</b>	=	DIAdem data with 32 bit in floating point displaying (REAL)
<b>R64</b>	=	DIAdem data with 64 bit in floating point displaying (REAL)
<b>WAV</b>	=	Audio file in WAV format
<b>AVI</b>	=	Video file in AVI format
<b>CSV</b>	=	Comma Separated Values
<b>Jxx</b>	=	Binary file with job result

After reaching the consecutive file number 9999 (CCCC), counting starts again with 0001!

If the file with this number still exists, it is overwritten with new data!

Recorded signals are divided into different files accordingly to data type, i.e. all 8 bit signals unsigned are in a \*.W8 file, all 32 bit signals signed in a \*.I32 Datei, etc.

#### Important advices:

TESTdrive defines the number of the storage group during the initialization process. An assignment of the storage group number to the order in the configuration interface is not given.

All information of a storage group is stored in the DAT file. The DAT file has a 8 bit ASCII format (ANSI code page 1252, ISO 8859-1).

The storage group name can be defined with IPEmotion and is also stored in the DAT file.

All project information are stored in the DAT file (vehicle no., project name, etc.). At working with classifications, the DAT file contains additional fields to define the classification in detail.

## 11.5.1 Data types

### Time-related data (Storage group)

The header file and the corresponding data files are created for every storage group (= signals with common storage rate).

#### Example (Acquisition no. 699 > DOBBCCCC.DDD)

<b>Storage group 1</b>	DO010699.DAT	Header
	DO010699.R32	32 Bit (Real)
	DO010699.W16	16 Bit (Word unsigned)
	DO010699.W32	32 Bit (Word unsigned)
<b>Storage group 2</b>	DO020699.DAT	Header
	DO020699.W8	8 Bit (Byte unsigned)
	DO020699.W32	32 Bit (Word unsigned)
<b>Storage group x</b>	DO0x0699.DAT	Header
	DO0x0699.W8	16 Bit (Word unsigned)

### Statistics

TESTdrive saves classification data in DIAdem format, which includes all parameters in one header file. This header file includes additional information about classification description. Corresponding to the storage groups and the general DIAdem conventions, binary data is included in the same files. These files are separated accordingly to data type and are defined by an extension corresponding to data type, e.g. \*.W32, \*.R64.

The results of several classifications of the same data type are stored in one binary file. Most classification types create results of the W32 data type. The retention time classification can create different data types.

#### Example (Acquisition no. 699 > COBBCCCC.DDD)

<b>Header</b>	CO010699.DAT	Header
<b>Classification m ... n</b>	CO010699.W32	32 Bit (Word unsigned), can include several classifications
	CO010699.R64	64 Bit (Real), can include several classifications

## Audio recording

A DIAdem acquisition and one or several audio files (WAV format) are created with an audio recording.

The DIAdem acquisition contains the trigger event, the WAV file includes the audio data.

Every audio file is assigned to one triggering event. The names of the audio files include the counter value of the trigger channel to create a direct reference within the acquisition data. The respective audio file is recorded for the time of an activated trigger.

### Example DIAdem file (Acquisition no. 699 > A000CCCC.DDD)

<b>Trigger channel</b>	A0000699.DAT	Header
	A0000699.W16	16 Bit (Word unsigned)

### Example audio file (Acquisition no. 699 > ABBBCCCC.WAV)

<b>Audio sequence 1</b>	A0010699.WAV	Audio data of 1. trigger event
<b>Audio sequence 2</b>	A0020699.WAV	Audio data of 2. trigger event
<b>Audio sequence x</b>	A00x0699.WAV	Audio data of 3. trigger event

## Video recording

A DIAdem acquisition and one or several video files (JPG = single image or AVI = video sequence) are created with an video recording.

The DIAdem acquisition contains the trigger event, the JPG or AVI file includes the video data.

Every video file is assigned to one triggering event. The names of the video files include the counter value of the trigger channel to create a direct reference within the acquisition data. The respective video file is recorded for the time of an activated trigger. Exactly one single image is saved per trigger event, independent of the trigger duration.

### Example DIAdem file (Acquisition no. 699 > V000CCCC.DDD)

<b>Trigger channel 1 (Video)</b>	V0000699.DAT	Header
	V0000699.W16	16 Bit (Word unsigned)

or

<b>Trigger channel 1 (Image)</b>	I0000699.DAT	Header
	I0000699.W16	16 Bit (Word unsigned)

### Example video file (Acquisition no. 699 > VBBBCCCC.AVI)

<b>Video sequence 1</b>	V0010699.AVI	Video data
<b>Video sequence 2</b>	V0020699.AVI	Video data

or

<b>Image 1</b>	I0010699.JPG	Image data
<b>Image 2</b>	I0020699.JPG	Image data

## Diagnostic acquisition

### Error memory and non-recurring data

TESTdrive creates additional files for error memory and non-recurring data. This CSV file (BDJDcccc.CSV) is an overview and includes all information about the completed jobs. Every successful job is saved in a binary file (BDS1cccc.Jxx), which contains the actual data.

A CSV file\*\*, as well as, the corresponding jobs are created after the completed acquisition of UDS services.

**\*\* A CSV file is only created in binary mode, not in trace modeT.**

The names of the single acquisition files are generated according to **BDPECCCC.DZZ** structure:

BDPECCCC.DZZ	with P = U (UDS protocol), P = K (KWP protocol)
BDPECCCC.DZZ	with E = ECU number (1 ... 9)
BDPECCCC.DZZ	with D = J (Job or binary file), D = T (Trace file)
BDPECCCC.DZZ	with ZZ = Job number (01 ... 99)

### Example non-recurring data (Acquisition no. 699 > BDPECCCC.DZZ)

<b>Trace file</b>	BDU10699.T01	UDS protocol, ECU no. 1, Acquisition no. 699, Job no. 1
<b>Binary file</b>	BDU10699.J01	UDS protocol, ECU no. 1, Acquisition no. 699, Job no. 1
<b>CSV file</b>	BDJD0699.CSV	Job overview of binary files

## Measurement status file

Measurement status file in XML format offers information about the process of a completed acquisition. This includes:

- Acquisition start and stop (... in standardized XML format "DateTime")
- General system information (hardware, TESTdrive version,...)
- Storage group trigger
- Acquisition / Diagnosis information
- Limit violations
- Maneuver detection

Measurement status file is created after acquisition stop and is stored in the zip container of the acquisition (MEA\_xxxx.zip) or attached to the status e-mail if this file creation has previously been activated in IPEmotion **Options > PlugIns > IPETRONIK LOG > PlugIn specific settings > Options > General > Create measurement status file.**

### Example Measurement status file (measurement number 699 > MSxxyyyy.xml)

xx = Append number, yyyy = Measurement number

<b>Measurement status file 1</b>	MS010699.xml
<b>Measurement status file 2</b>	MS020699.xml

If an acquisition is later continued (Append mode), TESTdrive increases the append number in the file name.

## Min-Max list (STG file)

TESTdrive creates a separate statistic file (STG file) to record minimum and maximum values as well as first and last valid value of selected signals. The STG file is created at the end of each measurement, if the **Logger processing** contains a **Statistic group** containing at least one channel. The statistic file is stored in the zip container of the acquisition (MEA\_xxxx.zip)

### Example STG file (Acquisition no. 699 > STBBCCCC.STG)

<b>STG file 1</b>	ST010699.STG	Min / Max data of storage / process group 1
<b>STG file 2</b>	ST020699.STG	Min / Max data of storage / process group 2

## Traffic recording (CAN, LIN)

TESTdrive saves traffic acquisitions in binary format. A traffic acquisition can include two binary files:

- Traffic data recorded by TESTdrive during boot time
- Traffic data recorded by TESTdrive during run time

Advice: Storage of CAN traffic data and LIN traffic data in the same file

The names of the single acquisition files are generated according to **TBBBCCCC.BIN** structure:

<b>TBBBCCCC.BIN</b>	Traffic data recorded by TESTdrive
<b>TBBBCCCC.BIN</b>	Consecutive number within an acquisition
<b>TBQSCCCC.BIN</b>	Traffic data recorded by micro controller

## Maneuver recording

TESTdrive creates a file in ASCII format for maneuver recordings.

The maneuver file functions like a storage group, i.e. the file receives a consecutive number within the acquisition.

The names of the single acquisition files are generated according to **MVBBCCCC.ASC** structure:

<b>MVBBCCCC.ASC</b>	Name of respective storage group
---------------------	----------------------------------

### Example (Acquisition no. 699 > MVBBCCCC.ASC)

<b>Storage group 1</b>	DO010699.DAT	Header
	DO010699.I16	16 Bit (Integer signed)
<b>Storage group 2</b>	DO020699.DAT	Header
	DO020699.R32	32 Bit (Real)
<b>Maneuver file</b>	MV030699.ASC	