

M-LOG V3 & COMgate V3

INTELLIGENT WEB PORTAL FOR CENTRAL MONITORING
AND MANAGEMENT OF DATA LOGGER FLEETS



Access measurement data worldwide using wireless connections, update measurement configurations online, monitor logger health status and much more.



Table of contents

Table of contents	2
1 Important and general information	7
1.1 Important information	7
1.1.1 Safety and Warning instructions	7
1.1.2 Liability, Warranty, Copyright, License agreement	7
1.2 General information	8
1.2.1 About this manual	8
1.2.2 Legend of used icons	8
1.2.3 New features, Changes	9
1.2.4 Support	15
1.2.5 Related documentation	15
1.2.6 Documentation feedback	15
2 System basics	16
2.1 Data logger applications (extract)	16
2.1.1 Configuration, Online measurement using Ethernet	16
2.1.2 Fleet data logger	16
2.2 Connecting devices via CAN bus	17
2.2.1 CAN bus basics	17
2.3 Ampacity and voltage drop	19
2.3.1 Ampacity	19
2.3.2 Voltage drop	19
3 Data logger M-LOG, S-LOG, FLEETlog/FLEETlog2, IPElog	20
3.1 Overview	20
3.2 Hardware	22
3.2.1 Block diagram	22
3.2.2 Enclosure types	22
3.2.3 Port replicators and cables	23
3.2.4 Device panel for changing the internal memory card	23
3.2.5 External fuse for logger protection (IPElog, M-/S-LOG, FLEETlog)	23
3.2.6 Additional short-circuit protection for IPElog and FLEETlog	24
3.2.7 LED status display (flashing codes)	24
3.2.8 Power-down at excitation loss	24
3.3 Initial start-up	25
3.3.1 Connecting the logger	25
3.3.2 Detecting the logger, creating test configuration (Ethernet)	26
3.3.3 Add logger system, creating test configuration (USB stick)	27
3.3.4 Static and dynamic IP addresses	28

3.3.5	Logger web interface for status and signal monitoring	29
3.3.6	Logger system with CAN modules	30
3.3.7	Access to data stored on the logger	31
3.3.8	Synchronizing the logger time	32
3.3.9	Readout Hardware and license information.....	32
3.3.10	Updating the measurement application (TESTdrive) per USB stick.....	33
3.3.11	TESTdriveCMD.xml	34
4	External connection	36
4.1	Grounding.....	36
4.1.1	IPElog, M-LOG grounding connection	36
4.1.2	FLEETlog grounding connection	36
4.2	PWR / Remote connection.....	36
4.2.1	PWR/REM cable 620-574	36
4.2.2	Remote connection	37
4.3	Digital input/output connection	38
4.3.1	Connecting example digital input.....	38
4.3.2	Connecting example digital output.....	38
4.3.3	Connecting example external status LED.....	39
4.4	Bus inputs.....	39
4.4.1	Connecting example CAN bus.....	39
4.4.2	Connecting example LIN bus.....	39
5	Configuration with IPEmotion (extract)	40
5.1	First steps.....	40
5.1.1	Main dialog.....	40
5.1.2	The Title Bar	41
5.1.3	The file menu	41
5.1.4	Using the options	41
5.1.5	Creating a support file.....	47
5.1.6	IPEmotion working areas (main navigation tabs)	48
5.1.7	Info	49
5.2	Logger settings.....	50
6	Basic functions.....	53
6.1	Switching-on / switching-off.....	53
6.1.1	Ignition line 15.....	53
6.1.2	WakeOnCAN	54
6.1.3	WakeOnRTC (IPElog/IPElog2 only)	55
6.1.4	StopStart event (Logger processing)	56
6.1.5	Use Cases.....	57
6.2	Triggering	60
6.2.1	Start-trigger	60

6.2.2	Stop-trigger	60
6.2.3	Start- and Stop-trigger	61
6.2.4	Stop is inverted start	61
6.2.5	Save trigger channel	62
6.3	Data groups (storage, e-mail, traffic, statistic, novalue).....	63
6.3.1	Storage groups	64
6.3.2	Mail groups.....	65
6.3.3	Statistic group	67
6.3.4	NoValue group	68
6.3.5	Traffic groups	68
6.3.6	Trigger settings	69
6.4	Status channels.....	70
6.4.1	Logger, Logger processing	70
6.4.2	Video recording.....	70
6.5	USB medium for external storage.....	71
6.5.1	External medium is the data drive of the logger	71
6.5.2	External USB medium as supplemental data drive	72
7	Standard functions.....	76
7.1	Calculations.....	76
7.1.1	Mathematic functions and operations	76
7.1.2	Constants	80
7.1.3	NoValue and timeout settings.....	80
7.1.4	Calculation examples.....	83
7.1.5	Calculation	87
7.2	Digital inputs and outputs.....	88
7.2.1	Digital inputs	88
7.2.2	Digital outputs	88
7.3	WakeOnCAN.....	90
7.3.1	ON via WakeOnCAN, OFF via Ignition 15.....	90
7.3.2	ON via WakeOnCAN, OFF via Switch-off condition	90
7.4	CAN-Send: Output signals to CAN bus	91
7.5	Log file output via Hyperterminal.....	94
7.6	Send e-mail with status information	95
7.7	Output messages to CAN / LIN.....	96
7.8	Event controlled measurement	98
7.8.1	Possibilities for data acquisition	98
7.8.2	Cyclic data recording of continuous signals.....	99
7.8.3	Event-controlled data recording of bus signals.....	100
7.8.4	Setting up event-controlled data recording (PlugIn IPETRONIK-LOG).....	101
7.8.5	Practical example: Determination of the latency of two signals.....	104

8	Options (license required)	105
8.1	Hardware options (internal)	105
8.1.1	CAN cards	105
8.1.2	CAN / LIN cards	105
8.1.3	Ethernet cards	105
8.2	Software options	106
8.2.1	Import signal description files	106
8.2.2	Detection mode and cycle rate	114
8.2.3	Traffic acquisition	114
8.2.4	Statistics calculation	119
8.2.5	Operating in FTP mode (terminal server)	121
8.2.6	Recording audio and video data	121
8.2.7	OBD-2 measurement	122
8.2.8	UDS protocol (Unified Diagnostic Services)	124
8.3	Recording GPS-Data	125
8.4	Remote data transfer	126
8.4.1	Transferring data using GPRS and Internet to FTP server	126
8.4.2	Transferring data using Wireless LAN to network server	127
8.4.3	Data transfer configuration	128
8.5	Configuring COMgate	129
9	Display modules	133
9.1	M-VIEW <i>fleet</i>	133
9.1.1	Keys and LEDs	134
9.1.2	Configuring M-VIEW <i>fleet</i>	135
9.2	IPEconnect (Online display with Smartphone or tablet)	138
9.2.1	Overview	138
9.2.2	Features	138
9.2.3	Cables	139
9.2.4	Settings	139
9.2.5	App display	141
9.3	Connecting displays via openABK	142
9.3.1	Cable connection	142
9.3.2	Display configuration	142
9.3.3	Use display buttons for triggering	142
10	Accessories	143
10.1	Electrical accessories	143
10.1.1	COMgate	143
10.1.2	Extender	144
10.1.3	IPEwifi	144
10.1.4	GPS receiver	146

10.1.5	Bus isolator SAM-CAN-ISO	146
10.1.6	iMIC	146
10.2	Mechanical accessories	148
10.2.1	Module mounting	148
11	New features	149
11.1	PlugIn / TESTdrive V03.56.....	149
11.1.1	Measurement data processing	149
11.1.2	Status information (online).....	149
11.2	PlugIn / TESTdrive V03.57.....	151
11.2.1	Measurement data processing	151
11.2.2	Data storage	152
11.2.3	Data transfer & communication	153
12	Appendix	154
12.1	Cable connection and Pin assignment.....	154
12.1.1	M-LOG port replicators	154
12.1.2	FLEETlog2-01	157
12.1.3	FLEETlog2-03.....	158
12.1.4	FLEETlog	159
12.1.5	IPElog.....	160
12.1.6	IPElog2-01 (16 CAN).....	161
12.1.7	IPElog2-02 (10 CAN, 6 LIN).....	162
12.2	Starting up.....	163
12.2.1	Overview Configuration & Measurement	163
12.2.2	Flow chart of the measuring process.....	164
12.3	Practical examples	165
12.3.1	Calculating memory footprint	165
12.3.2	Linear signal scaling	166
12.4	Status messages.....	169
12.4.1	Most important status messages	169
12.4.2	Warning and error messages after program update.....	170
12.5	Description of TESTdrive files.....	171
12.5.1	Data types	172

1 Important and general information

1.1 Important information

Please follow these instructions before and during the use and application on any IPETRONIK product!

1.1.1 Safety and Warning instructions

Please follow the instructions **and** information as contained in the user manual!

1. The user can **influence an electronic system by applying the IPETRONIK product**. This might cause risk of personal injury or property damages.
2. The **use and application of the IPETRONIK product is permitted only to qualified professional staff**, as well as, only in appropriate manner and in the designated use.
3. **Before using an IPETRONIK measurement system** in the vehicle it **has to be verified that no function of the vehicle, which is relevant for secure operation, might be influenced**:
 - by the installation of the IPETRONIK measurement system in the vehicle,
 - by an potential malfunction of the IPETRONIK system during the test drive.

In order to avoid possible danger or personal injury and property damages, appropriate actions are to be taken; such actions have to bring the entire system into a secured condition (e.g. by using a system for emergency stop, an emergency operation, monitoring of critical values).

Please check the following points to avoid errors:

- Adaption of sensors to components of the electrical system / electronics, brake system, engine and transmission control, chassis, body.
- Tap of one or several bus systems (CAN, LIN, ETHERNET) including the required electrical connection(s) for data acquisition.
- Communication with the vehicle's control units (ECUs), especially with such of the brake system and/or of the engine and transmission control (power train control system).
- Installation of components for remote data transmission (mobiles, GSM/GPRS modems, WiFi and Bluetooth components).



4. IPETRONIK devices are designed for applications in **extended temperature ranges > 70 °C (158 °F)**. A high environmental temperature and the module's self-heating may cause burns of the skin when touching the hot surface. In order to avoid the risk of injury we recommend to take care for appropriate safety precautions (e.g. contact protection, covering/enclosure, warning sign, ...).
5. **Before** directly or indirectly using **the data acquired by an IPETRONIK measurement system to calibrate control units, please review the data regarding to plausibility**.
6. With regard to the application of IPETRONIK products in vehicles during use on public roads the manufacturer and/or registered user of the vehicle **has to ensure that all changes/modifications have no influence concerning the license of the vehicle or its license of operation**.
7. **User does agree to the instructions and regulations as mentioned above**. In case the user does not agree with the instructions and regulations as mentioned above, he has to notify this expressly and immediately in writing to IPETRONIK before confirming the sales contract.

1.1.2 Liability, Warranty, Copyright, License agreement

Please refer to <http://www.ipetronik.com/en/terms-conditions> for detailed contract information:

- ▶ Limitation of liability
- ▶ Warranty
- ▶ Copyright and Duplication
- ▶ Software license agreement

1.2 General information

1.2.1 About this manual

The manual describes the structure of the IPEmeasue data logger devices M-LOG / M-LOG V3, S-LOG, FLEETlog / FLEETlog2 and IPElog / IPElog2, as well as, peripheral devices and accessories components.

© 2018 All rights reserved !

IPEmotion PlugIn IPETRONIK-LOG

Descriptions in this documentation refer to the current release. Please note, that the logger requires the corresponding application software TESTdrive.



To run this PlugIn an release ≥ IPEmotion 2017 R2 has to be installed on your computer.

IPEmotion

Contents described in this document relates to the release versions IPEmotion 06.00.00 (2016) to IPEmotion 07.02.00 (2017 R3).

IPEmotion 2017 requires Microsoft .NET 4.5.1 Framework. This version is no longer supported by Windows XP.

1.2.2 Legend of used icons

**Tip**

This icon indicates a useful tip that facilitates the application of the software.

**Information**

This icon indicates additional information for a better understanding.

**Attention!**

This icon indicates important information to avoid potential error messages.

1.2.3 New features, Changes

Please also refer to the latest release notes at:

c:\Program Files (x86)\IPETRONIK\IPEmotion PlugIn IPETRONIK LOG V03.5x.xx\Help\

PlugIn IPETRONIK-LOG V03.61		Release May 2018
No.	Feature	Description
1	Bug fixing, optimizations	M-CNT2, M-LOG V3, CAN FD Satellite according to the release notes

PlugIn IPETRONIK-LOG V03.60		Release January 2018
No.	Feature	Description
1	PlugIn LOG / X in parallel	Activating the PlugIn IPETRONIK-LOG and the PlugIn IPETRONIK-X (simultaneous operation) is supported.
2	openABK functions	Implemented functions of the logger display & control concept openABK buttons, openABK DHCP server, openABK unique names

PlugIn IPETRONIK-LOG V03.59		Release November 2017
No.	Feature	Description
1	IPElog2 access point	WiFi access point support
2	IPEwifi V3	External device for WiFi data transfer with M-LOG V3
3	Transfer category FTP server	Up to 3 categories can be assigned to an FTP server
4	Transfer category LOG files	Up to 3 categories can be assigned to the log file
5	XCP: Disconnect Second Tester	Delay time after the the second tester will be disconnected
6	ECU CCP parameters	Optionally use CCP parameters from ECU
7	UDS security access	Security access for the UDS protocol
8	SFTP resume	Resume is active: The data transfer will be continued where it has been stopped with the previous transfer. Resume inactive: A corresponding and already existing file on the FTP server will be overwritten.
9	Transmit traffic messages	Transmit messages in traffic groups
10	IPElog2 gyro sensor	Support of IPElog2 internal gyro sensor
11	Data transfer parameters	Default values for data transfer parameters have been adapted
12	Project properties	Project properties are no longer stored in mea_conf
13	PlugIn LOG / X in parallel	PlugIn IPETRONIK-LOG and IPETRONIK-X activated in parallel might cause software problems

PlugIn IPETRONIK-LOG V03.58		Release February 2017
No.	Feature	Description
1	Cisco VPN removed	Cisco VPN settings will be deleted when loading a former configuration (GUI access no longer supported).
2	SW filter frequency selection	Software filter frequency now as drop-down menu selection
3	Export of channel comments	Activation at Options > PlugIns > IPETRONIK LOG > IPEmotion settings > Options > Extended > IPETRONIK CAN, default = deactivated
4	New OBD channels	Supported PIDs: 102 - 106, 108 - 110, 112 - 124, 127, 131
5	Radius calculation (polar)	$Radius = \sqrt{(\text{"phi_y"} * \text{"phi_y"} + \text{"phi_z"} * \text{"phi_z"})}$
6	Angle calculation (polar)	$Angle = \text{IF}(\text{"phi_z"} \geq 0; \text{ACOS}(\text{"phi_y"} / \text{"Radius"}) * 180/\text{PI}; -1 * \text{ACOS}(\text{"phi_y"} / \text{"Radius"}) * 180/\text{PI} + 360)$
7	Calculation ISNOVSALUE	ISNOVALUE (x;y), NoValue detection with delay
8	External video data storage	Storing video data on external USB medium
9	Sign-of-live	Connecting status between logger and web interface
10	Measurement status file with wake up reason	New entry wake up reason: Unknown/ Remote/ Wake On CAN/ No Message Lost/ Wake On RTC/ Modem (SMS)/ low voltage
11	TESTdriveCmd DataTransfer	The new parameter „transfer“ controls the data post processing. Depending on its status (true/ false) zipped and splitted files will be copied to the USB stick subsequently.
12	Remote2 (M-LOG V3, IPElog2)	2nd input in addition to the control input Remote 1 (e.g. ignition line 15) as OR-conjunction solely supported with the Power-IN/Remote connector of M-LOG V3 and IPElog2

PlugIn IPETRONIK-LOG V03.57		Release July 2016
No.	Feature	Description
1	IPElog2 support	Hardware type 10x CAN, 6x LIN, 2x ETH, WLAN Hardware type 16x CAN, 2x ETH, WLAN
2	Quickstart data options	Off, During boot-up, During boot-up + Measurement Stop-Start
3	Available WLAN networks	Cyclic SSID scan provides latest WLAN status information (logger with built-in WLAN unit required)
4	New UDS super job	PST_LESEN_UDS_2
5	UDS check string	Comparing the „SearchString“ of the UDS job and the ECUs reply
6	Indication of CAN/LIN bus activity	Creating status entry in Log file / Measurement status file once the timeout delay of the respective CAN/LIN input expired
7	Hardware description file	New backup of the HW_descr.xml prevents from illegal access
8	Data post processing	User configurable Start Delay / Retry Delay time (range 10 s ... 5 min) to trigger the parallel data post processing
9	Use last value from previous measurement	Using the last value from previous measurement as start value for a signal calculation within the current measurement
10	Category overview	Selection list for the data transfer category
11	XCPonUDP import	Import of A2L description files using an USB2ETH adapter

PlugIn IPETRONIK-LOG V03.56		Release April 2016
No.	Feature	Description
1	Multi CAN-Send	CAN node supporting multiple CAN-Send blocks
2	GPS channels added	GPS latitude in degrees, GPS longitude in degrees
3	openABK capable display	Support of the openABK protocol V1.0 for EMBU-SYS displays
4	Logger status info	Web interface showing logger status information and signal list
5	IPEconnect access point	IPEhub2 supports access point operation for online data visualization with mobile devices (smartphone, tablet)
6	J1939 extension	Event trigger measurement in signal mode
7	UDS extension Second Tester	Configuration of an additional tester ID

PlugIn IPETRONIK-LOG V03.55		Release August 2015
No.	Feature	Description
1	M-LOG V3	Support of new data logger M-LOG V3
2	FLEETlog2-03	Support of FLEETlog2 with D Sub D connector (CAN, DI/O)
3	IPElog 6x CAN, 6x LIN	Data logger IPElog providing 6 CAN and 6 LIN inputs available
4	M-VIEWfleet, scaling	Multipoint scaling for M-VIEWfleet supported
5	USB video	- Support of multiple USB cameras via USB hub - Support of Logitech QuickCAM VisionPro (DID 0x09A6)
6	Mail groups, recipients list	Separate list of mail recipients per mail group
7	Serial number specific program/configuration update (mcf, fcf, rtb, prg)	Verification of the logger serial number for program/configuration update (mcf, fcf, rtb, prg). In case of mismatch, the latest valid file is used.
8	Import of PDX files	One or more PDX files can be imported for each CAN node
9	NoValue group	Extended NoValue monitoring with with new data group „NoValue group“ (Logger processing). User defined formulas for trigger conditions are supported.
10	Send category „NoTransfer“	Additional send category „NoTransfer“ in order to exclude user defined data from transfer.
11	CCP, XCP second tester	Check for second tester connected to the bus before starting ECU communication.
12	CCP, XCP EPK mismatch	Selectable behaviour in case of EPK mismatch. (default setting: proceed measurement)
13	New parameter <meaNumber> for TESTdriveCmd.xml	The service <dataTransfer> now provides the new parameter <meaNumber> in order to send defined mea files in advance (per modem), instead of at the end of the test drive trip.
14	IPEconverter	Refer to manual IPEconverter V03.55 for latest extensions

PlugIn IPETRONIK-LOG V03.54		Release November 2014
No.	Feature	Description
1	M-LOG 6 CAN M-LOG 3 CAN / 1 LIN	Support of new M-LOG measurement interfaces
2	New CAN devices	Support of M-SENS2 250 Hz, M-UNI2, M-THERMO2 HV, CANpressure 150 bar
3	Diagnostic measurement	Set trigger conditions to start diagnostic jobs
4	CAN Timeout value	User defined value for the timeout. Without a valid signal value after the timeout has expired, the system will indicate "NoValue"
5	DAQ polling groups (polling list)	ECU signals can be allocated to different polling groups. Up to 4 groups can be defined by user
6	Seed&Key file using the XCP protocol	Set file location for the Seed&Key file.
7	XCPonCAN extension	New Protocol status channel with XCP, CCP, KWP, UDS
8	CAN-Send extensions	New columns bit count and data format added
9	Statistic Group (Min/Max list) (STG file)	Activation of the min/max list calculation has been modified. Requested signals can be assigned to max number of 4 statistic groups.
10	File transfer categories	Storage, traffic and statistic groups can be assigned to a file transfer category. Each of 3 categories can use a data transfer medium (LAN, WLAN or COMgate).
11	Disable USB stick data exchange	Automatic data download / configuration upload can be enabled/disabled with the PlugIn options settings.
12	Logger reset	Reset the logger to factory default settings (DIN 01 = active)
13	IPEcloud	Define access parameters for data download from FTP server. Measurement data can be imported directly using IPEmotion's Data manager and Analysis tools.
14	J1939 extensions	Activate J1939 protocol information DM1 messages conversion methods
15	DLM	Optional path for user operations (DLM) C:\Users\Public\Documents\IPETRONIK\IPEmotion\Custom\User Operation
16	XCPonCAN and XCPonUDP with additional storage rates	30/min, 12/min, 6/min, 1/min, 2/h, 1/h
15	IPElog extensions WakeOnSMS Rescue configuration Provider blacklist	Start IPElog per SMS from standby mode Export rescue configuration Create provider blacklist to exclude them for data transfer
16	Time zone status information	Enable the use of time zone status information (UTC status) with the PlugIn options settings
17	exFAT format of the SSD card used with IPElog	Format SSD drive using the exFAT data format which support memory sizes up to 512 Terra bytes
18	S.M.A.R.T.	Support of Self-Monitoring, Analysis and Reporting Technology with the appropriate storage medium

PlugIn IPETRONIK-LOG V03.54		Release November 2014 (continuation)
No.	Feature	Description
19	Event based measurements in MDF4 data format	Channels of a CAN measurement with disabled cyclic acquisition (Event controlled) will be stored using the MDF4 format.
20	Count ECU data requests	All ECU data requests (means successful and unsuccessful attempts) will be logged.
21	Mail groups	Support of sending e-mails parallel to data post processing.
22	IPEconverter extensions ASAM ATF/XML export DIAdem TDM/DAT export CSV, Excel2003/2010 export	NoValue handling, grouping mode new data format types V-TAB scaling, rounded floating values

PlugIn IPETRONIK-LOG V03.53		Release April 2014
No.	Feature	Description
1	LOG2PC (ETH communication) IP 239.192.0.5 at port 7302	The UPD based protocol uses multicasts now, Firewall settings must not refuse the use of this port/IP.
2	TESTdrive update to V03.53.xx	Execute initial update of the logger software by USB stick. Following updates are supported by LOG2PC as usual.

PlugIn IPETRONIK-LOG V03.52		Release December 2013
No.	Feature	Description
1	FLEETlog2 support	Data logger FLEETlog2 is supported now
2	CAN-Send extensions	Send counter with individual settings for start bit, bit length, and data format, Signal output with individual settings for start bit, bit length, and data format in expert mode
3	J1939 extensions	J1939 protocol including DM1 signals refer to separate documentation J1939_DM1
4	OBD 2 extensions	Single PID, status channel, trigger conditions
5	External storage medium (USB)	Selectable for signal and traffic storage groups TESTdriveCmd.xml required
6	Traffic measurement extensions	Ring buffer, Filter functions
7	CAN ID assignment	Automatic assignment during system identification > IPEmotion Options > PlugIn specific settings
8	Measurement stop with automatic restart	StopStart event (logger processing) stops the current measurement and restarts immediately
9	New status signals	Video file size, Measurement number, OBD-2 processing
10	New calculation	INT_ADD()
11	Hardware license information	Logger context menu Extras shows hardware license information from the description file (hw_descr.xml)
12	Licensing of traffic groups	License verification of storage and traffic groups

PlugIn IPETRONIK-LOG V03.51		Release July 2013
No.	Feature	Description
1	PIN assignment	FLEETlog and IPElog added
2	Traffic storage groups	Traffic measurement now support different storage groups
3	Extension for IPElog (requires PIC ≥ V01.01.07, FPGA ≥ V01.02.08)	NoMessageLost function (NML) WakeOnCAN can be activated for each channel up to 6 ID triggers Logger restart using WakeOnCAN or remote signal CAN-ID trigger now StartNotStopTrigger (instead StartOnly) PIC update per job executable Status indication of the flap for the storage medium with M-VIEWfleet
4	CCP	Command CCP_DISCONNECT implemented
5	Upload and download	Supported with different transfer media (Modem, WiFi)
6	Event controlled measurement	CAN data acquisition based on traffic measurement but handled as signal measurement (DAT format)
7	Masks	for CAN identifiers are supported now
8	File name length	Up to 260 characters are allowed for file names of the external library and configuration files.
9	Stop date, Stop time	Stored as project property with the traffic file
10	PreTriggerTime, PostTriggerTime	Supported as project property

PlugIn IPETRONIK-LOG V03.50		Release October 2012
No.	Feature	Description
1	Notes Version reference SC1200 IPElog	Logger PlugIn ≥ 3.5x requires IPEmotion ≥ 2.xx M-LOG with SC1200 is no longer supported Requires TESTdrive / PlugIn IPETRONIK-LOG ≥ 3.5x
2	Status signal "FIFO overrun"	Indicates the data processing status. Output 0 = OK, Output 1 = processor overloaded
3	Debounce time of the remote signal	Configurable delay time within a range of 0 ... 5 seconds. The signal status ist valid if the remote signal lasts for this time without interruption.
4	Extensions TESTdriveCmd.xml	New jobs "OnOK" and "OnError" used for audible alarm of the job "OnConnect"
5	Differnt init modes for module initialization	Connected IPETRONIK modules will be initialized on command: Never, Once-only, Always.
6	Status e-mail with snap shot report	Each time the trigger condition is fulfilled, the current signal values (configured in the mail group) will be sent per mail.
7	Limit display with M-VIEWvga	Indication of limit violation has been revised.
8	V-TABs enable clear text display	Individual text can be assigned to different signal values (or ranges) which is respectively displayed (instead of digits).

1.2.4 Support

Headquarter:

IPETRONIK GmbH & Co. KG

Im Rollfeld 28

76532 Baden-Baden, Germany

Phone +49 7221 9922 0

Fax +49 7221 9922 100

info@ipetronik.com

www.ipetronik.com

Limited commercial partnership with its head office in Baden-Baden, registry court HRA No. 201313

IPETRONIK Verwaltungs-GmbH Baden-Baden is an individually liable society, registry court Mannheim HRB No. 202089

CEOs: Andreas Wocke, Christian Buchholz

Technical support and product information

www.ipetronik.com e-mail: support@ipetronik.com

1.2.5 Related documentation

IPEmotion

The documentation IPEmotion.pdf provides you with a description and useful information related to IPEmotion. This documentation is stored in the following standard language dependent directory:
C:\Programs\IPETRONIK\IPEmotion Vxx.xx.xx\Help

1.2.6 Documentation feedback

At IPETRONIK, the technical publications team strives to produce documentations of the highest quality and values your feedback as a reader and user. If you have any comments or suggestions regarding our product manuals, contact us under support@ipetronik.com .

When commenting on our products, please include the following information:

Version number

Name of the guide

Page number or section title

Brief description of the content (e.g. inaccurate instructions, grammatical errors, or information that require clarification)

Any suggestions for a general documentation improvement

2 System basics

2.1 Data logger applications (extract)

2.1.1 Configuration, Online measurement using Ethernet

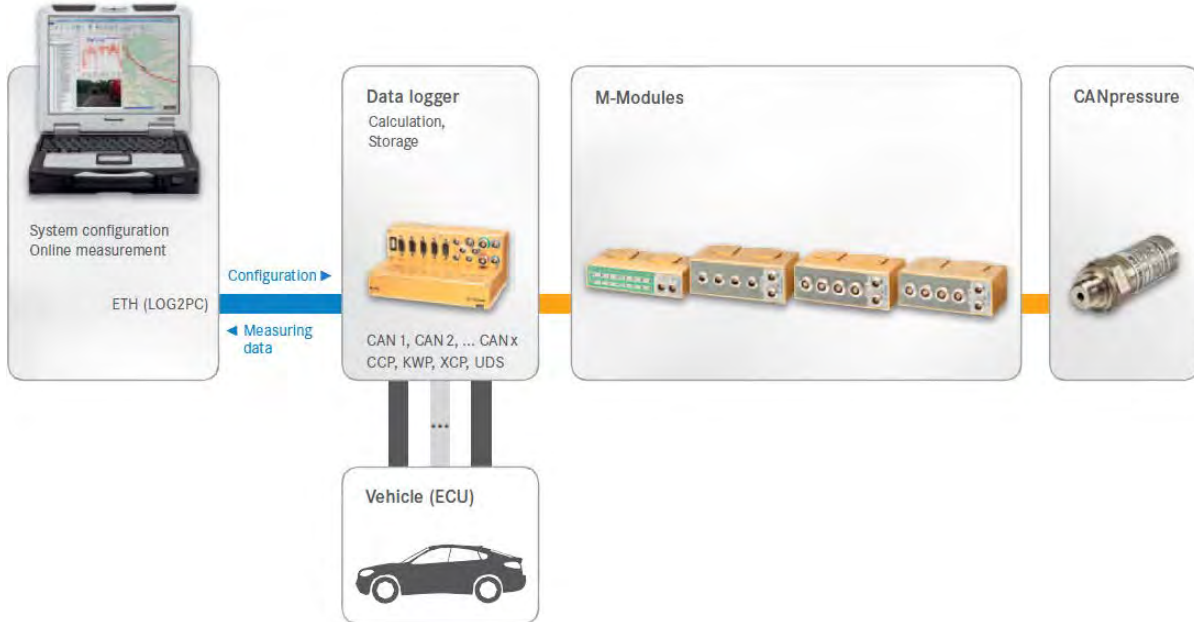

2.1.2 Fleet data logger

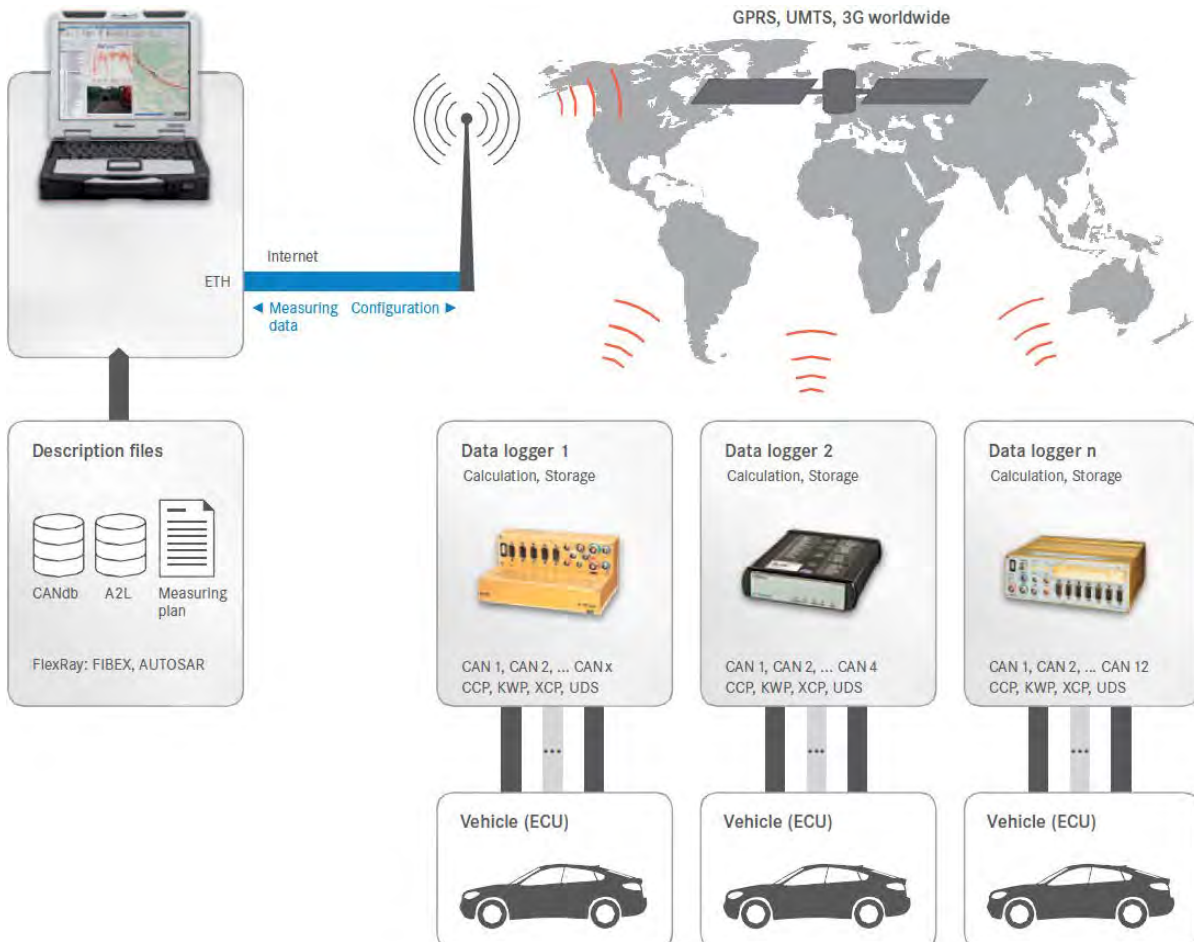

2.2 Connecting devices via CAN bus

2.2.1 CAN bus basics

CAN-Standard

The communication of the IPETRONIK SIM and M devices takes place by using the CAN bus according to the CAN 2.0 A (11 Bit Identifier) and CAN 2.0 B (29 Bit Identifier) specification. Each software application, which is able to process CAN data through a suitable interface can acquire measurement data from IPETRONIK CAN devices.

User data within the CAN message:
A CAN message can transfer 8 values in Byte format resp. 4 values in Word format.

Structure of a CAN message

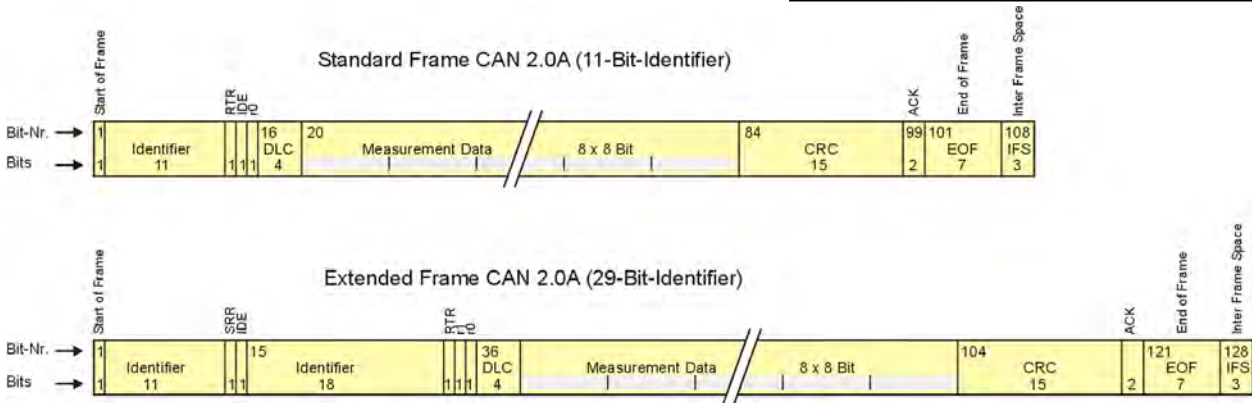

CAN 2.0A (11 Bit Identifier)			CAN 2.0B (29 Bit Identifier)		
Bits		Description	Bits		Description
1	SOF	Start of Frame	1	SOF	Start of Frame
11	ID	Identifier	11	ID	Identifier
1	RTR	Remote Transmission Request	1	SRR	
1	IDE	Identifier Extension (0)	1	IDE	Identifier Extension (1)
			18	ID	Identifier (extended)
			1	RTR	Remote Transmission Request
			1	r1	
1	r0		1	r0	
4	DLC	Number of following data bytes	4	DLC	Number of following data bytes
64	Data	Data bytes	64	Data	Data bytes
15	CRC	Error Identification Code	15	CRC	Error Identification Code
2	ACK	Acknowledge	2	ACK	Acknowledge
10	EOF	End of Frame, Inter frame space	10	EOFS	End of Frame, Inter frame space
110		Total number of bits	130		Total number of bits

Word	Byte	Bit (Message layout in the displaying format „Intel Standard“)							
0	0	7	6	5	4	3	2	1	0
	1	15	14	13	12	11	10	9	8
1	2	23	22	21	20	19	18	17	16
	3	31	30	29	28	27	26	25	24
2	4	39	38	37	36	35	34	33	32
	5	47	46	45	44	43	42	41	40
3	6	55	54	53	52	51	50	49	48
	7	63	62	61	60	59	58	57	56

Access to the CAN bus, Transferring properties

The CAN bus allows a safe and effective data transfer of the connected devices (non-destructive bitwise arbitration = resource distribution to different devices). The CAN bus is therefore used as a standard communication medium in the automotive area and the industrial automation.

The most important characteristic CAN bus properties are:

- ▶ Every bus participant (node) can send, as well as, receive.
- ▶ First of all, the node, which wants to send, needs the authorization. All participants become automatically a recipient (There is no abortion of the data sending process > non-destructive collision).
- ▶ No stations are addressed but messages.
- ▶ Every message is characterized by its name (Identifier).
- ▶ The less the identifier, the higher the message priority.
- ▶ A message can transport up to $8 * 8 \text{ Bit} = 64 \text{ Bit}$ (8 Byte) user data, whereas each message requires 110 Bit or 130 Bit (Extended ID).
- ▶ Depending on the hardware and the bus line length, up to 1 MBit/ s can be transferred.

The following important conclusions result from the properties above:

- ▶ The less the bus load, the less the probability of a "Bus access conflict" (you can call this a real-time capable area).
- ▶ A high bus load forces stations to loose messages with a high identifier or to send them more slowly. Messages with a high identifier can "get lost".
- ▶ Not sent messages are only registered by the "Recipient node" because data are missing. If no timeout has been defined, the last valid value is generally sent, i.e. a mistakenly constant value.

Transfer rate, Bus line length

The CAN bus supports a max. transfer rate of 1 MBit/s according to Norm ISO 11898-2. This value is limited in practice by the following points:

- ▶ the bus line length
- ▶ the branch line length to the CAN stations
- ▶ the bus lines quality and the plug contacts
- ▶ the bus line design (twisted, single or two-wire bus)
- ▶ bus connection structure and
- ▶ type and strength of external perturbations

Example

Data rate on the bus	1 MBit/s = 1 μ s/Bit
Data length of a CAN message	130 Bits total
User data in a message	64 Bit = 4 values with 16 Bit resolution each
Time for a CAN message	130 Bit x 1 μ s/Bit = 130 μ s/message i.e. 4 values require 130 μ s
Calculating the total sampling rate	130 μ s match 7.69 kHz
Converted to one channel	4 x 7.69 kHz = 30.76 kHz
Theoretical transfer rate	30 channels with 1 kHz = 30 kHz
Practical experiences	26 channels with 1 kHz = 26 kHz (The value is lower at guaranteed synchronicity.)

If CAN messages are not completely used (e.g. only three 16 bit values instead of four per message), less data can be transferred although the sum sampling rate has not yet reached the maximum. This also applies if different sampling rates are defined in one system, because the data division to the CAN messages is not time-optimized (minimum time required).

2.3 Ampacity and voltage drop

Besides the fact that the max. bus line length is defined by the desired data transfer rate, the ampacity and the voltage drop in the system have primarily to be checked. This is especially important for systems with a high number of devices and/or long connections lines of the devices (e.g. distributed systems with connection lines of 3 m (9.84 ft) and more between the device groups). Additional actions should be taken accordingly to the situation.

2.3.1 Ampacity

The maximum current via the M-CAN system cables (e.g. 620-560.xxx) is 4 A (heat generation by transition resistances of the plug contacts).

The system capacity and therefore the power consumption can approximately be calculated by using the number of devices (including the sensor supply). A direct power acquisition in the real system provides exact values.

We recommend one or several of the following actions if the limit value is exceeded:

- ▶ Increasing the supply voltage of the devices (e.g. 24 V DC power supply or 42 V DC instead of 12 V)
- ▶ Centered voltage supply via T connection or as close as possible to the devices with high power requirements (rather than at the beginning or end of the system chain)
- ▶ Additional system supply via a T connection at a suitable position

2.3.2 Voltage drop

Even if the limit value for the ampacity is not reached, long lines in an extensive system can cause perturbations in the acquisition process. This mainly applies to devices at the end of the system chain, because the voltage of the last devices does not exceed the input threshold of 9 V (due to a high voltage drop in the system).

We recommend one or several of the actions mentioned above.

The voltage drop can be calculated by using the following formula:

$$U = R \times I$$

$$R = 2 \times R_{\text{Cable}} [\Omega/\text{m}] \times \text{Length}_{\text{Cable}} [\text{m}]$$

$$I = P_{\text{Devices}} [\text{W}] / U_{\text{Devices}} [\text{V}]$$

For estimating the voltage drop, a resistance of

- > 50 mΩ/m for the M-CAN cables and
- > 35 mΩ/m for the SIM-CAN cables

can be used including the transition resistances of the plug contacts. Systems, which are in the limit range of the voltage drop, should be controlled in individual cases. To do so, our support will be pleased to assist you.

As the power consumption of a device depends on the supply voltage, it is useful to calculate the voltage drop from the chain end to the feeding point. In this case, a minimum voltage of 9 V is set to the last device and the required excitation is calculated. The calculated value should be generously rounded upwards for guaranteeing a safe operation.

Another fact is the variable internal resistance of the input power supplies (low excitation = lower internal resistance).

In practice, this means: If the net excitation decreases (e.g. because of a weak power supply or a high resistivity with long cables), the devices have to readjust to cover the current power requirements. This causes a higher power consumption, which additionally increases the voltage drop.

3 Data logger M-LOG, S-LOG, FLEETlog/FLEETlog2, IPElog

3.1 Overview

Device	IPElog2	IPElog	M-LOG V3	FLEETlog2	IPEhub2
Operating system	RTOS 32 (32 bit)	RTOS 32 (32 bit)	RTOS 32 (32 bit)	RTOS 32 (32 bit)	Linux (32 bit)
Processor	Intel ATOM T3805	Intel ATOM T3805	Intel ATOM T3805	LX800	Arm
RAM memory	2 GB	2 GB	2 GB	256 MB	256 MB
Data loggers software	TESTdrive	TESTdrive	TESTdrive	TESTdrive	IPEhub
Removable storage medium	cFast	SSD	cFast	CF	SD
Storage capacity	8/ 16/ 32/ 64	8/ 16/ 32/ 64/ 128	8/ 16/ 32/ 64	8/ 16/ 32	1 / 2 / 4 / 8
Software					
Configuration software	IPEmotion	IPEmotion	IPEmotion	IPEmotion	IPEmotion
No Message Lost (NML)	■	■			
Wake on CAN (WoC)	■	■	■	■	
Wake on LIN (WoL)	■				
Wake on FlexRay (WoFR)					
Wake on SMS (WoSMS)	■	■			
Wake on Real Time (WoRTC)	■	■			
On board scripting					
On board math & logic operations	■	■	■	■	
File formats for data storage	DAT, BIN, AVI, WAV, MDF4.1	DAT, BIN, AVI, WAV, MDF4.1	DAT, BIN, AVI, WAV, MDF4.1	DAT, BIN, AVI, WAV, MDF4.1	HRD
Interfaces					
Ethernet interface to PC	1 GigETH	100 Mbit	100 Mbit	100 Mbit	100 Mbit
USB 2.0 ports	2	2	2	2	
USB 3.0 ports					
Lemo, 9-pin for M-CAN modules	1	1	2	1	1
CAN HS (ISO 11898-2)	■	■	■	■	■
CAN LS (Low Speed)	■	■	■		
CAN FD					
LIN (1,3 & 2.0)	1 ... 6		1 ... 4		
ETH (100 Mbit)	1	2	2		
ETH (1 GigETH)	1				
FlexRay	1 (By extender)	1 (By extender)	1 (By extender)		
Digital I/O	4/4	4/4	4/4	2/2	
COM (serial RS232)	1		2		
Audio input / output	1		1		

Device	IPElog2	IPElog	M-LOG V3	FLEETlog2	IPEhub2
Driver display system	IPEmotion app / openABK	IPEmotion app / openABK	IPEmotion app / openABK	IPEmotion app / openABK	IPEmotion app
Interface option 1	10 CAN + 6 LIN + 2 ETH	12 CAN + 2 ETH	12 CAN	4 CAN	2 CAN
Interface option 2	16 CAN + 2 ETH		8 CAN + 4 LIN		
Interface option 3			8 CAN + 2 ETH		
Interface option 4			6 CAN + 2 LIN + 2 ETH		
Interface option 5			4 CAN + 2 ETH		
Extender boxes	FlexRay-Extender	FlexRay-Extender	FlexRay-Extender , COMgate V3, IPEWiFi		
Protocols and traffic					
CCP / XCP on CAN	■	■	■	■	
J1939	■	■	■	■	
GM-LAN	■	■	■	■	
OBD	■	■	■	■	
WWH-OBD	■	■	■	■	
KWP on CAN	■	■	■	■	
UDS / ODX / PDX	■	■	■	■	
XCPonETH	■	■	■	■	
FlexRay / XCP on FlexRay	■	■	■		
MOST (25 / 150)					
openABK	■	■	■	■	
SOME IP					
FlexRay traffic					
CAN traffic	■	■	■	■	■
LIN traffic	■				
CAN traffic send	■	■	■	■	■
Wireless communication					
GNSS (Global Navigation Satellite System)	20 Hz (GPS)	1 Hz (GPS)	1 Hz (GPS)	1 Hz (GPS)	
Gyro sensor	100 Hz				
WiFi	2.4 GHz (WiFi 802.11 b/g)	2.4 GHz (WiFi 802.11 b/g)	via COMgate V3	2.4 GHz (WiFi 802.11 b/g)	2.4 GHz (WiFi 802.11 (b/g))
Modem	3G (UMTS/HSDPA)	3G (UMTS)	via COMgate V3	3G (UMTS)	
VPN tunnel			via COMgate V3		
IPEcloud / FTP server	■	■	■	■	
Video					
IP-Camera (RTSP protocol)					
USB Video Class (UVC)	■	■	■	■	

Data transfer range of built-in modems (FLEETlog, IPElog)

- Frequency range Quad-Band EGSM 850 / 900 / 1800 / 1900
- Download rate HSDPA 7,2 Mbps
- UMTS/HSDPA (WCDMA/FDD) 2100 MHz
- GPRS multi-slot class 12
- Edge multi-slot class 12

3.2 Hardware

3.2.1 Block diagram

The block diagram shows the basic structure of the logger board.

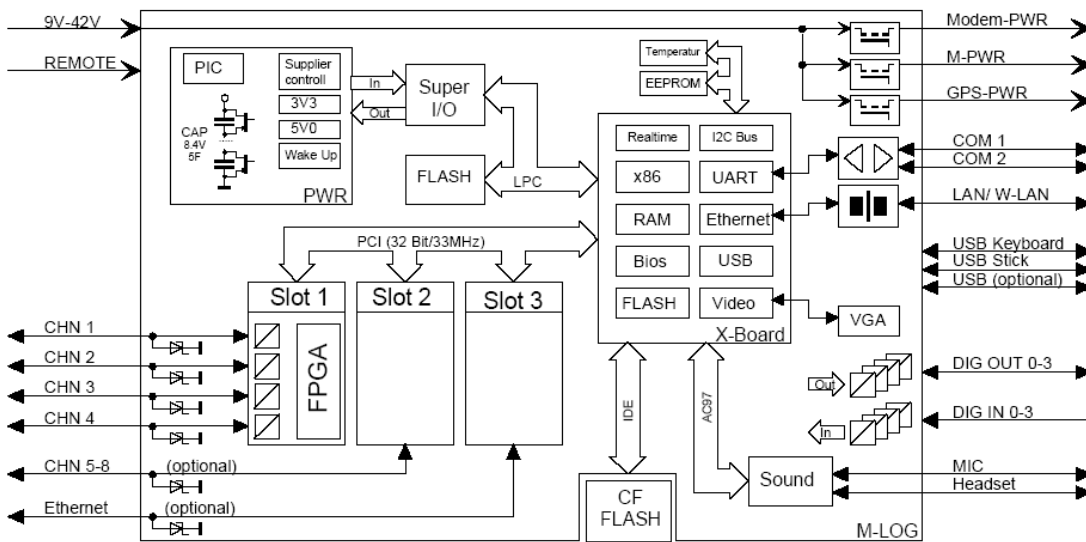

3.2.2 Enclosure types



M-LOG with port replicator PR05

S-LOG front view

FLEETlog front and rear view

The M-LOG enclosure is compatible to all M devices. The devices can be easily connected with each other with a dovetail adapter. M-LOG is available with 6 different port replicators (cable connecting adapter). User specific port replicators are available on request.

The FLEETlog2 hardware concept was designed for using the data logger in vehicle fleets, whereas FLEETlog2 WAN is already equipped with modem, WiFi client, and GPS receiver.

3.2.3 Port replicators and cables

Various cables are available for every port replicator. The complete PIN configuration, as well as, the appropriate cables of the PR05 and PR08 port replicators are shown in the appendix.



3.2.4 Device panel for changing the internal memory card

S-LOG and M-LOG (M-LOG with Upgrade Kit 300) offer a screwed panel for exchanging the cF memory card if required.

The FLEETlog is equipped with a cF card slot behind the folding front panel.

IPElog has a screwless fixed front panel with open/close contact for exchanging the SSD memory card.



Please note the advice to only change the memory card in exceptional cases because of a possible intrusion of foreign material, dirt or water into the device and the logger could be damaged at removing the cF card. The regular data transfer should be done with the USB stick or the wireless connection (modem or WiFi option).

3.2.5 External fuse for logger protection (IPElog, M-/S-LOG, FLEETlog)



Depending on the number of inputs, capacitor charge, and connected devices (M or SIM devices, Modem, GPS receiver), the total power consumption (especially at temperatures of $-40\text{ }^{\circ}\text{C}$ / $-40\text{ }^{\circ}\text{F}$) can reach up to approx. 150 Watt. To protect the total system, we recommend an external overload protection with the following tasks:

- ▶ Protection of the supply line in error case
- ▶ Overload protection of the current source
- ▶ Logger protection.

We recommend using a **LittleFuse ATO Fuse Fast Acting Type** with a nominal current of 10 A. At using the maximum charge in ambient temperatures under $-40\text{ }^{\circ}\text{C}$ / $-40\text{ }^{\circ}\text{F}$, it can be required to increase the nominal current to 15 A.



The individual electric circuits (also see M-LOG Port replicators, S-LOG = PR05) are internally protected. The internal resistance of multifuse types increases exponentially and limits the current to a minimum. After clearing the cause of error, the resistance decreases to the normal value (automatic resetting).

The motherboard fuse does not work reversibly and must be replaced in the case of a required repair.

3.2.6 Additional short-circuit protection for IPElog and FLEETlog

As the M-CAN connection is not fused by the logger, we recommend to use the cable M-CAN Cable M-CAN/PWR-Fuse (No. 620-677.xxx) in order to prevent the logger from damage caused by a short circuit.

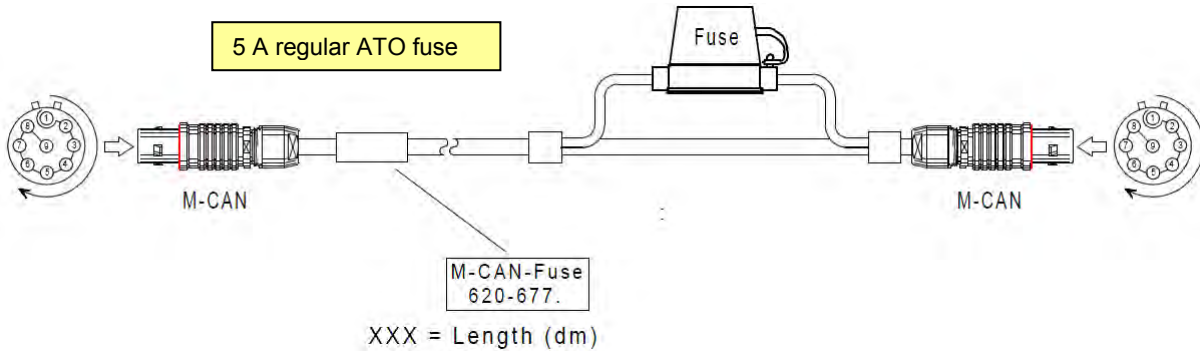

3.2.7 LED status display (flashing codes)

LED display	Mode	Meaning
GREEN	Ready or operating	Device is ready (Operation: see yellow LED)
	Warning I Low voltage	The excitation is between 6 V and 9 V. M-LOG shuts down after 2 minutes at unchanged status.
	Measurement running	The logger writes the data to the internal memory.
	Data medium access (post processing)	Prepare file transfer (zip, split)
	Data transfer	Transfer files via USB, modem, or WiFi
RED	Error, Emergency operation	e.g. at invalid configuration, at less memory capacity, at emergency shut-down due to less excitation A restart is required..

3.2.8 Power-down at excitation loss

M-LOG, S-LOG, FLEETlog and IPElog are equipped with high-powered capacitors, which guarantee a short excitation in the case of an excitation loss for regularly shutting the system down without data loss. The storage capacity of the capacitors depends on several points (e.g. ambient temperature, aging, charge condition). A data loss can therefore not completely be excluded in the case of a total excitation loss.

M or SIM devices, which are supplied by M-/S-LOG, FLEETlog C2 or IPElog, are immediately switched-off at excitation loss.



We recommend to revise the switching and the buffer capacitors every 2 years for guaranteeing a clean functionality. The device calibration every 2 years includes this revision.

3.3 Initial start-up

3.3.1 Connecting the logger

- ▶ Connect the red socket using the Power/Remote cable (e.g. 620-574.xxx) with an appropriate power supply (9 V_{DC} ... 36 V_{DC})
 - PWR+ = Voltage supply Plus
 - GND = Voltage supply Minus
 - REM = Ignition line 15 or power supply Plus via switch
 - Shield = Shield or voltage supply Minus

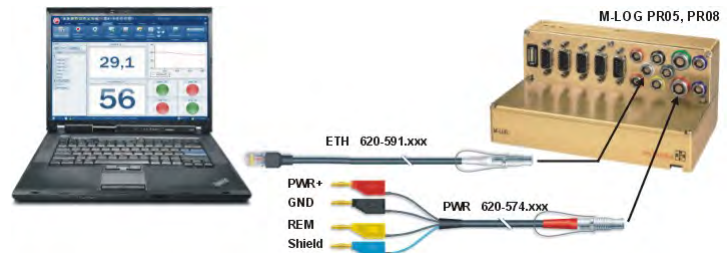

- ▶ Connect the white socket using the LAN cable (e.g. 620-591.xxx) with the Ethernet interface of a PCs/Notebook, resp. using the LAN cable (e.g. 620-355.xx) for connection to a network.
- ▶ Switch on the logger
 - REM = Ignition line 15 or power supply Plus via switch
 - green status LED lights continuously
- ▶ Logger starts up and will enter the measurement mode after a short time.
 - yellow status LED lights continuously
- ▶ Refer to the **Flow chart of the measuring process** in the appendix for more details.

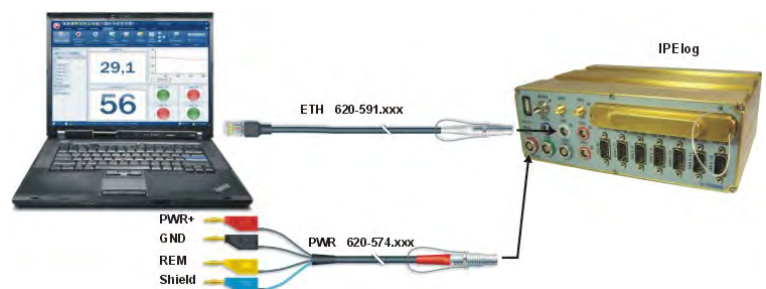
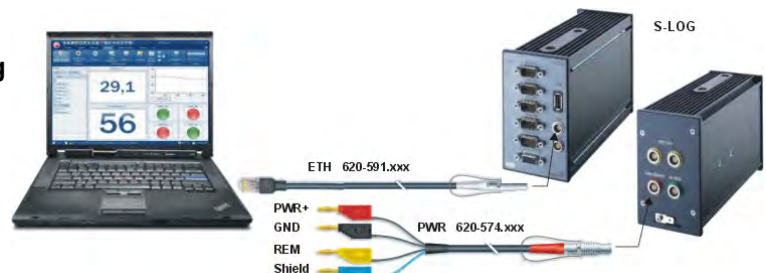
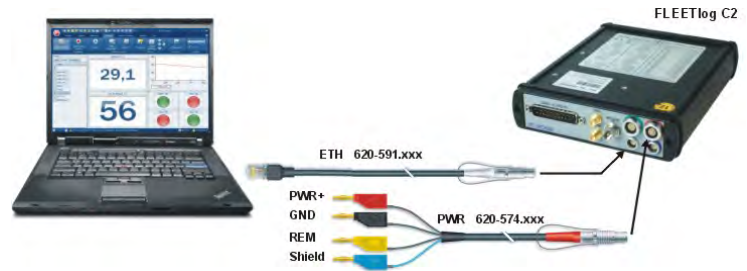

Useful notes

- ! If the Ethernet connection to the logger will not work properly, at first transfer the correct IP settings to the logger using an USB stick. Refer to **Add logger system, creating test configuration (USB stick)**.
- ! Using the cable **620-591.xxx LOG Cable ETHERNET (crosslink)** is a point-to-point connection between logger and PC. A fixed IP address is required for both. Refer to **Static and dynamic IP addresses**.
- ! When connecting the logger and the PC used for configuration and data acquisition to a network with DHCP server, both have to be set to dynamic IP address, in order to receive the individual IP address by the DHCP server automatically. In this case use cable **620-355.xxx M-LOG PR05 ETH Cable RJ45**.

Please consider the risk of IP conflicts (same IP address may exist twice), if you use static IP address settings when connected to a network with DHCP support.

3.3.2 Detecting the logger, creating test configuration (Ethernet)

- ▶ Start IPEmotion at your PC/Notebook.
- ! Using Logger PlugIn version ≥ 3.50 , IPEmotion ≥ 2.0 is required.

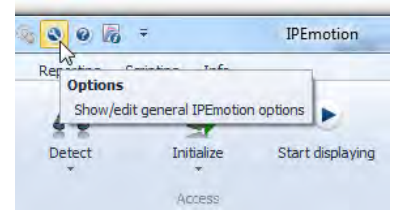

- ▶ Activate the PlugIn IPETRONIK-LOG.

Options > Plugins > IPETRONIK LOG

- ! The PlugIn IPETRONIK-LOG version 3.50 and higher requires TESTdrive ≥ 3.50 on the logger. Please update the logger application if necessary!

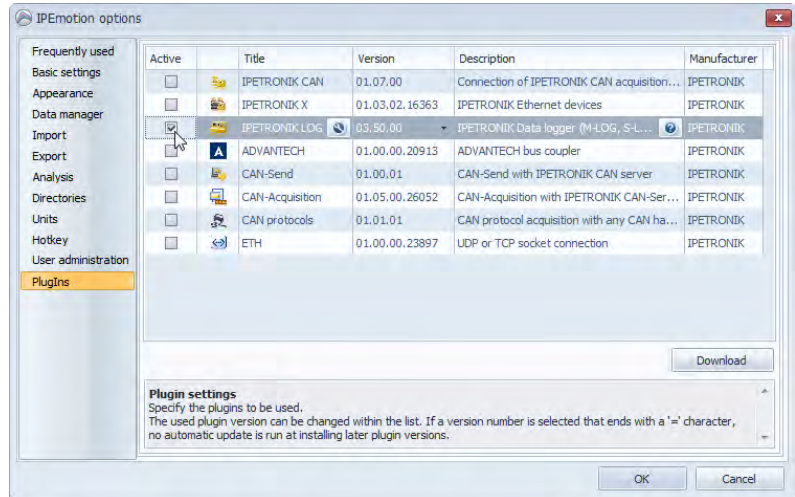

- ▶ Select the main tab **Signals**.

- ▶ Click **Detect** to identify the connected hardware components.
The / all available logger(s) will be displayed in a select list.
Confirm your selection by activating the corresponding checkbox and click OK. The configuration settings stored on the logger will be readout and displayed.

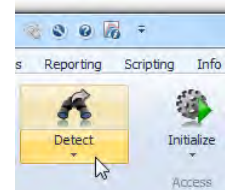

- ▶ Activate the status signal CPU load.

> Mark the logger at the left hand structure top area and scroll the signal list downwards to CPU load, hook **Active** to enable the checkbox.

- ▶ Select **ETH** from the left hand tree structure, right click and choose > **Add components** > **XCP service** from the context menu
- ▶ Select **DAQ list slow** from the left hand tree structure, right click and choose > **Add components** > **Channels** from the context menu
- ▶ Mark **CPU load** and confirm by clicking **OK**.

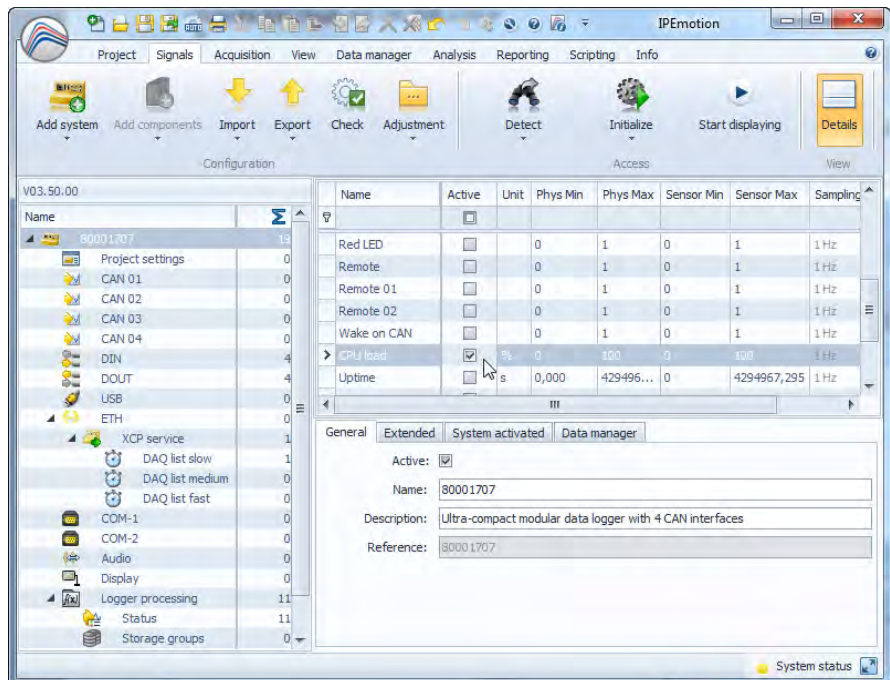

- ▶ Mark the logger from the left hand tree structure top area. Click **Start displaying** from the tool bar.
- ▶ Once the logger has been initialized, the current value of the CPU load is displayed continuously in the signal list. Now logger's ETH communication test and online data streaming via XCP service has been completed successfully.

3.3.3 Add logger system, creating test configuration (USB stick)

In case the data acquisition or the Ethernet connection is not working properly (e.g. when using obsolete / former configurations, incompatible IP address settings, ...), we recommend to transfer a valid (already successfully tested configuration) per USB stick to the logger.

- ▶ Create a logger system:
Select from the main tabs
Signals > Add system > e.g. M-LOG (4CAN)
- ▶ Enter the front number of the logger you will use:
> Mark the logger at the left hand structure top area and choose the **Extended** tab to set the last four digits of the logger's serial number using the field **Front number**.
- ▶ Select the **Data manager** tab and activate the check box **Update connection parameters** and click to **Configuration**
- ▶ Enter valid settings for the IP address used for the Ethernet connection (auto IP or fixed IP) as described at **Static and dynamic IP addresses**.

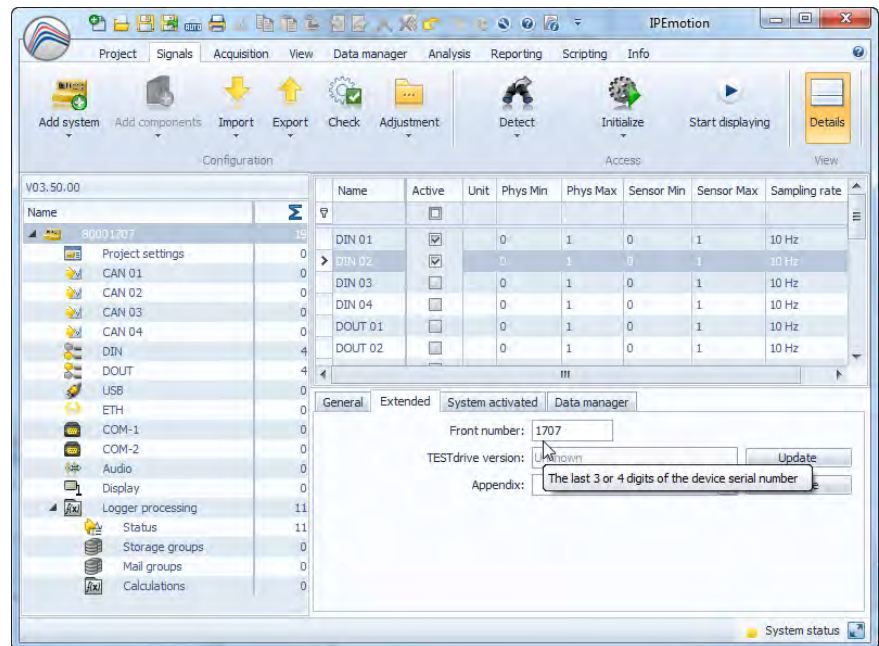

- ▶ Create a test configuration.
- ▶ Save the current configuration settings in the project (*.icf).
- ▶ Export the project as measurement configuration (TSTdrive.mcf) to an individual subdirectory located on your Notebook/PC or direct to an USB stick.
- ▶ Unplug the USB stick from the configuration PC.
- ▶ Switch on the logger.
- ▶ Plug in the USB stick while the logger is running in measurement mode (yellow LED lights). The logger will stop measurement and start data postprocessing, existing data will be moved to the USB stick. This process lasts as long as the yellow LED is flashing.
- ▶ Then the logger will search for a new measurement configuration on the USB stick. If a new configuration is found, the application on the logger will be updated and the origin TSTdrive.mcf on the USB stick is deleted.
- ▶ Wait until the yellow LED lights nor flashes not any longer and unplug the stick. The logger will switch to measurement operation again.



After all necessary connection parameters have been updated with valid settings (logger, PC), a communication via the LAN cable is supported, including these actions:

- ▶ transfer a new configuration to the logger,
- ▶ detect the logger and read the configuration from the logger,
- ▶ transfer measurement data from the logger to the PC (import measurement files).

3.3.4 Static and dynamic IP addresses

Basically IPETRONIK data loggers can be connected to other network clients via Ethernet in two different ways:

- ▶ Point to point connection between the logger and the PC/Notebook.
Usually neither the logger nor the PC/Notebook supports DHCP (Dynamic Host Configuration Protocol), it is necessary to set a fixed IP address for both.
- ▶ Client to client connection between logger and PC/Notebook through a local network. In this case the network server provides DHCP and manages the automatic IP address assignment to all network clients. Therefore logger and PC have to use dynamic IP address settings.

Use the **Data manager** tab to enter the settings for the logger:

- ▶ Mark the logger at the left hand tree structure top area.
- ▶ Select the **Data manager** tab from the right hand down area (configuration tabs) and activate the check box **Update connection parameters**.
- ▶ Click **Configuration**.
- ▶ Choose the tab **Medium selection** and activate **LAN**.
- ▶ Refer to the dialogs below for dynamic (Get IP address automatically) and static IP address settings.
- ▶ When using the static IP address with the logger, it is necessary to adapt the system control settings of the PC/Notebook,

For example:
 IP address: 192.168.0.100
 Subnet mask: 255.255.255.0

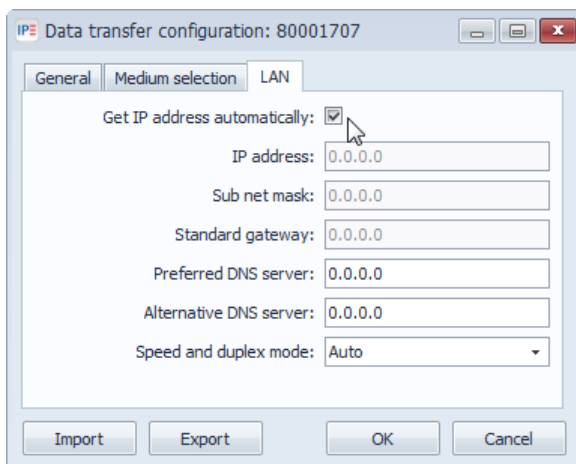
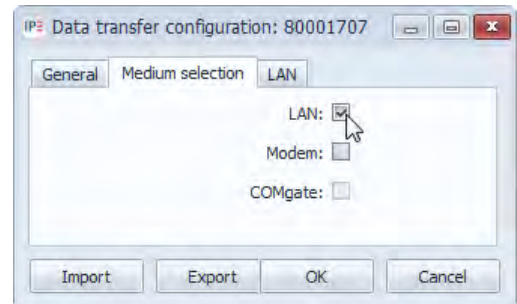
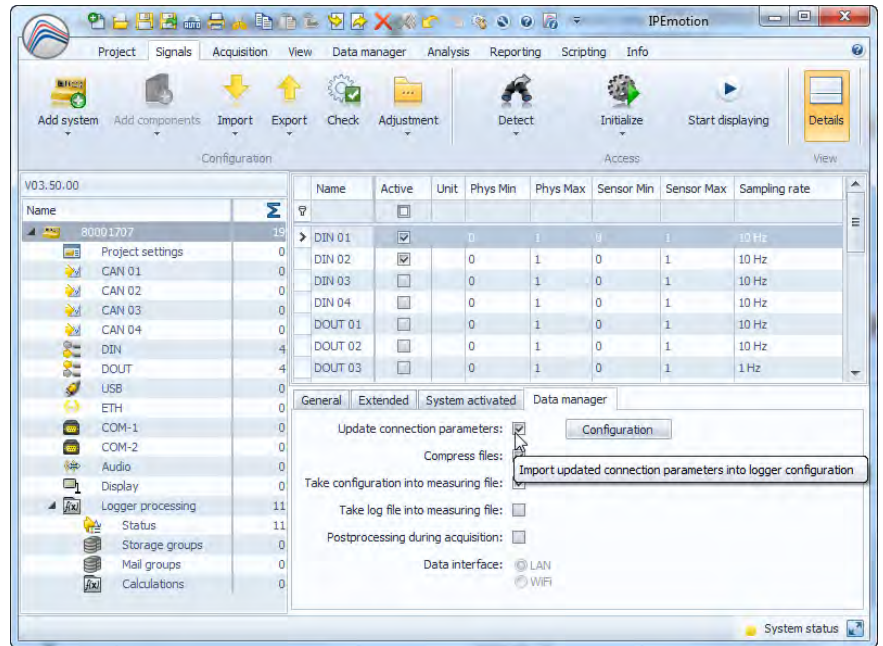

Settings for dynamic IP address

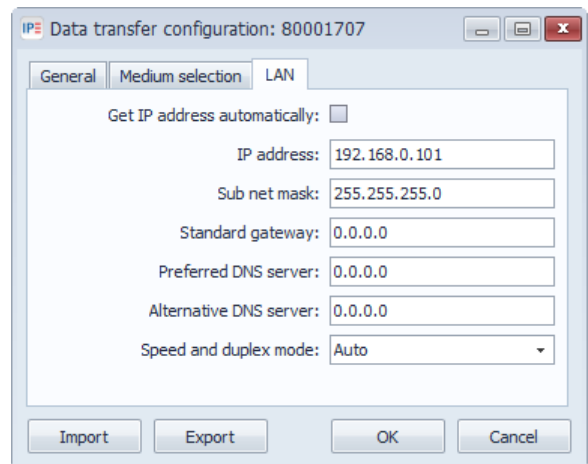

Settings for static IP address

3.3.5 Logger web interface for status and signal monitoring

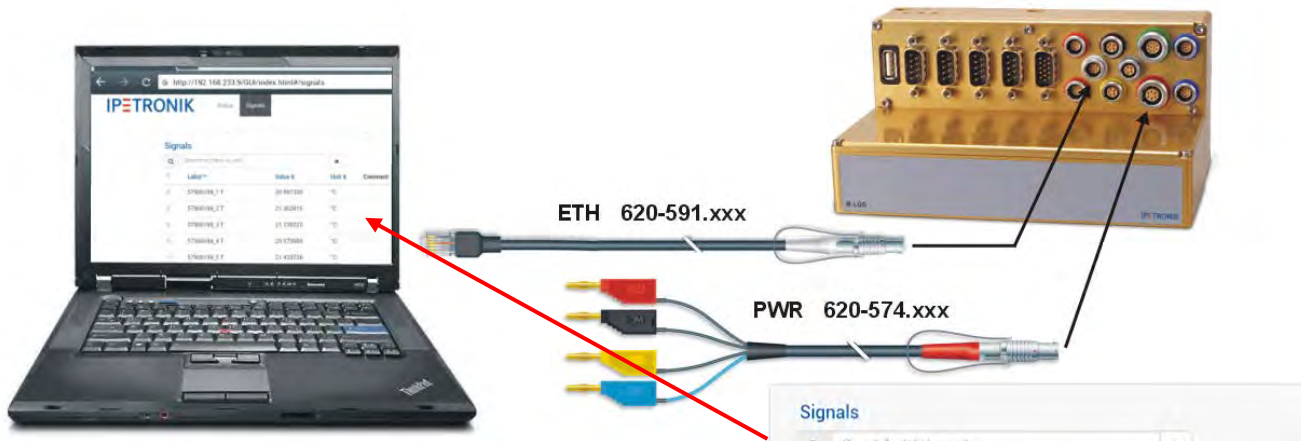

The logger service web site provides status information, the log file and a listing of all measured signals. An extra configuration by IPEmotion is not necessary. To start the site web just enter the logger IP address in the URL command line. The individual IP address of the logger is available from the ETH interface settings in the system structure of the logger configuration

Label	Value	Unit	Comment
57900199_1 T	20.997330	°C	
57900199_2 T	21.302815	°C	
57900199_3 T	21.739223	°C	
57900199_4 T	20.975509	°C	
57900199_5 T	21.433738	°C	
57900199_6 T	NoValue	°C	

Please also refer to **11.1.2 Status information**

Using the logger system with IPEhub2 and a mobile device (smartphone, tablet) or PC with WiFi port, a wireless access to the status web site and a user specific measurement data visualization is supported.

Refer to **9.2 IPEconnect (Online display with Smartphone or tablet)** for details

3.3.6 Logger system with CAN modules

All IPETRONIK CAN modules (M-Series, SIM-Series, CANpressure, MultiDAQ, High Voltage Iso DAQ ...) are connected to the data logger with corresponding system cables.

Connecting the modules

- ▶ Daisy-chain the modules among one another and connect the system with its respective cable to the logger.
- ▶ The end of the module chain has to be terminated with a termination plug.
- ▶ Using M-LOG or S-LOG the 2nd CAN bus socket has to be terminated also > use M-CAN or SIM-CAN termination plug.

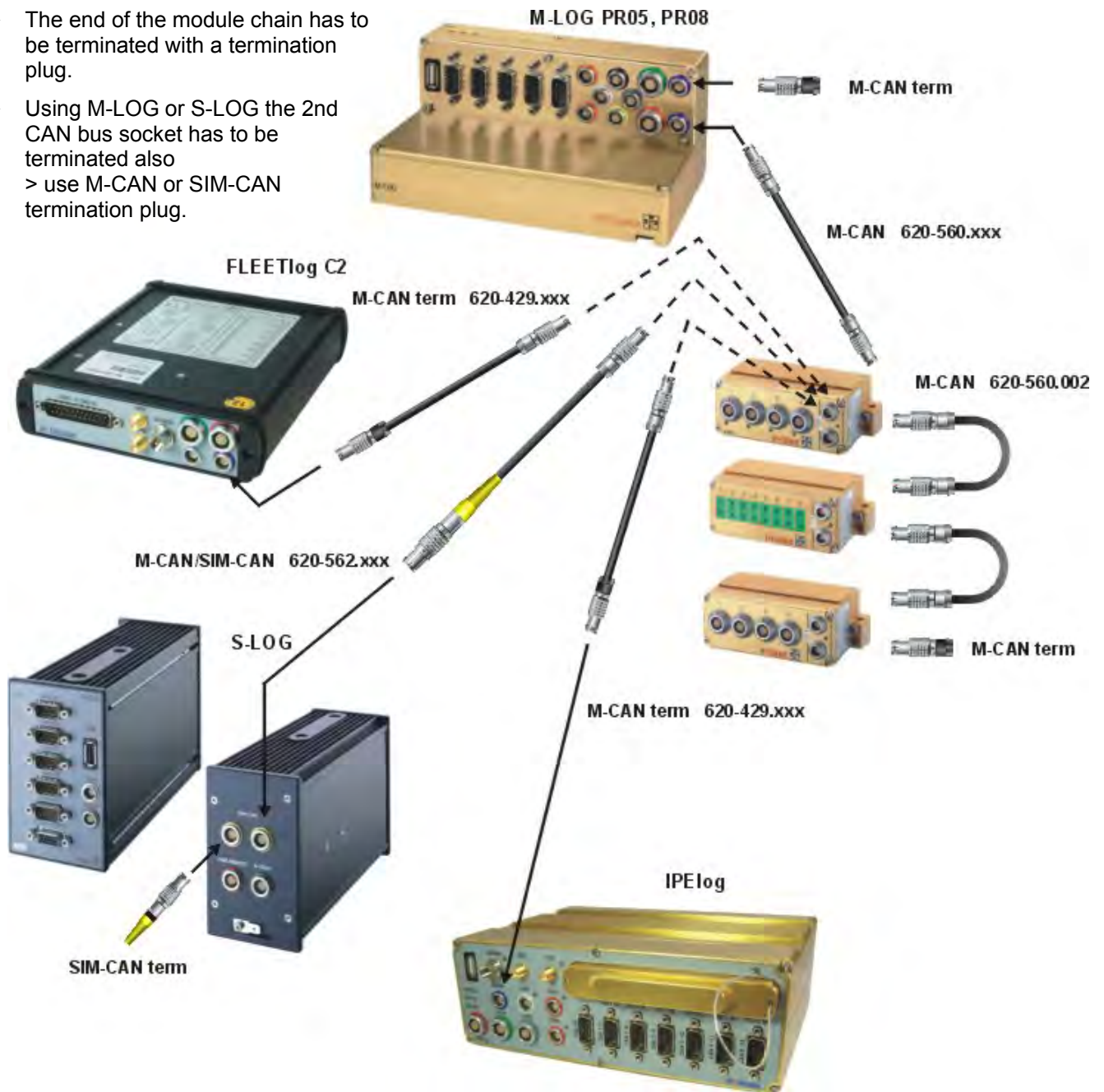

Usually all IPETRONIK CAN modules are connected to the logger through the system connectors M-CAN resp. SIM-CAN with S-LOG. Thus they can be detected and configured by IPEmotion in a user-friendly way. Besides this, it is also possible to connect IPETRONIK modules, as well as, non-IPETRONIK CAN modules to a free CAN measurement input. Please note, that you need a separate cable to supply the modules with power for this. Configuration of the modules is done manually or by importing a CANdb file.

Detecting modules, creating test configuration

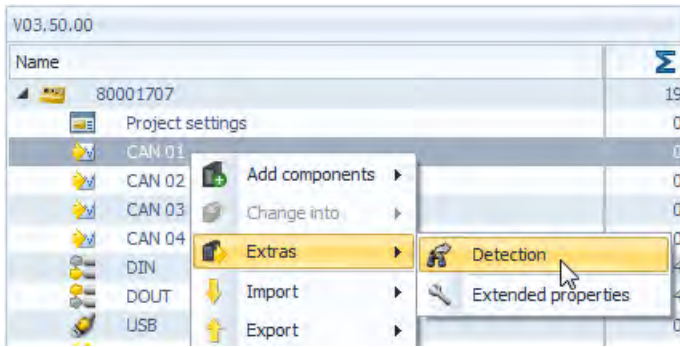

1. Select the CAN input to which the devices are connected to (CAN 01 is recommended because it is connected with the M-CAN or SIM-CAN socket at the logger).
 2. Select **Extras** from the context menu (right mouse button).
 3. Select **Detection** to detect the connected devices and to transfer the current settings to the configuration.
- MultiDAQ is detected as IPETRONIK CAN device from TESTdrive V03.22!**

- ▶ Execute **Detection** of connected modules as described.
- ▶ Configure the modules and the logger (activate channels, set signal scaling, select sample rates, create storage groups, ...)
- ▶ Save the current project.
- ▶ Initialize the Logger (working Ethernet connection required) or transfer the configuration per USB stick to the logger.



To display measurement data acquired by the logger using the Ethernet connection, you have to add an **XCP service** at first. Assign all signals to the DAQ lists of the XCP service which you want to be displayed. The **Options** setting **Automatic service administration** will automatically create an XCP service and assign all active signals to the DAQ lists.

3.3.7 Access to data stored on the logger

The logger stores all data in a Zip archive on internal storage medium (cF card, resp. SD card with IPElog).

- MEA_xxxx.zip measurement data + header file + current configuration
- LOG_xxxx.zip logfile with status reports of the data acquisition



A measurement file (archiv file) is empty, if the sum of the file contents calculated from the files listed below is 0. In this case, the respective zip archive will be deleted.

- all files containing storage groups except the DAT files
- all trace files (BD...)
- all statistic files except the DAT files
- Min/Max statistic file (STG)
- Audio/Video files except the DAT files (AVI, WAV, IMG)
- Traffic files (BIN, Quickstart)
- LOG file
- Measurement status file
- PPP debug file (PPP...)

Access (= data transfer to a PC or FTP server) to data stored on the logger is supported:

- ▶ per USB stick
- ▶ through an Ethernet cable connection
- ▶ using COMgate or an internal/external WiFi client
- ▶ using COMgate WAN or an internal/external modem

Using a LAN cable connection

Import measurement files / log files

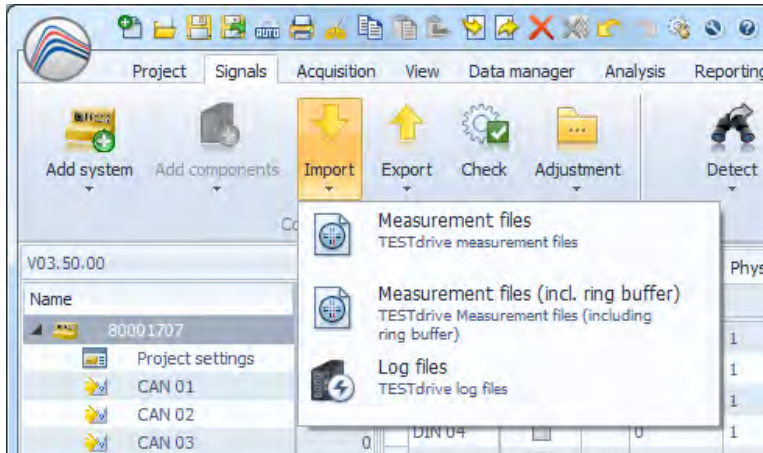

1. Select **Signals** navigation tab.
2. Select logger in the left **Systems** overview.
3. Transfer the current data (internal memory) in the **Signals** navigation tab to PC with **Import > Measurement files**.
4. Transfer the current data (internal memory + pre-/post-trigger data) in the **Signals** navigation tab to PC with **Import > Measurement files (incl. ring buffer)**.
5. Transfer the current TESTdrive log files in the **Signals** navigation tab to PC with **Import > Log files**.
6. Select the target directory or crate a new folder to save the respective data.

With USB stick

Plug in the USB stick to the running logger. The logger stops data acquisition, saves data, log files and the related configuration to the stick. If the yellow LED is not permanently on, disconnect the USB stick. The logger runs now in acquisition mode..



Please note that data can only be imported via USB if no LAN connection to the logger is activated. Disconnect the logger with the logger context menu.

3.3.8 Synchronizing the logger time

- ▶ Mark the logger at the left hand structure top area.
- ▶ Right click to the logger entry and select **Extras > Synchronize logger time** from the context menu.

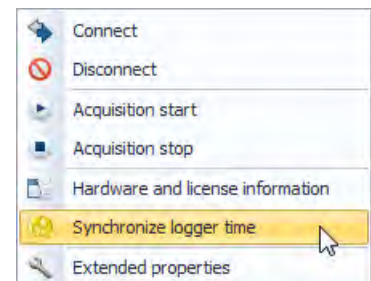

Time data of time stamp and log messages have been normalized. Now time stamp output is local time (former UTC). Time stamps reported in XML files always indicate the offset (time lag) to UTC time, e.g. <startdate>2012-04-25T09:30:10+01:00</startdate>

In order to ensure a correct time interpretation of recorded data, the IPETRONIK data converter IPEconverter V02.13 is required.

3.3.9 Readout Hardware and license information

Using the Ethernet connection (LOG2PC)

- ▶ Select the data logger on the top left area.
- ▶ Select **Extras > Hardware and license information** from the context menu by right-clicking.

Hardware and license information file (hw_descr.xml)

- ▶ Select the data logger on the top left area.

- ▶ Select **Extras > Hardware and license information from file** from the context menu by right-clicking.
- ▶ Look for the file **hw_descr.xml** locally or on a USB stick.



*Plug a USB stick into the running data logger to retrieve the license file (together with configuration and acquisition data). Unplug the USB stick from the logger and plug it into a PC. Go to the directory named with the logger's serial number, then go to the **DEVICE** subdirectory. The zip file TSTdrive contains the hardware/license file **hw_descr.xml**.*

3.3.10 Updating the measurement application (TESTdrive) per USB stick

Measurement application TESTdrive

- ▶ Copy the file **MLogger.rtb** (standard, inclosed in the TESTdrive_xxx.zip) or **Logger.prg** (for M-VIEWgraph, inclosed in the Setup_xxx.exe of the respective PlugIn) to the subdirectory named with the logger's serial number on the USB stick.
- ▶ Power up the logger and wait for the yellow LED which indicates data acquisition.
- ▶ Plug in the USB stick to the logger, program update will start automatically.
- ▶ Wait until the yellow LED lights no longer and unplug the USB.
The logger executes a reboot and starts measuring operation with the new application.

Measurement configuration (logger specific)

- ▶ Copy the file **TSTdrive.mcf** to the subdirectory named with the logger's serial number on the USB stick.
- ▶ Power up the logger and wait for the yellow LED which indicates data acquisition.
- ▶ Plug in the USB stick to the logger, configuration update will start automatically. As soon as the update has been completed successfully, the TSTdrive.mcf will be deleted from the USB stick.
- ▶ Wait until the yellow LED lights no longer and unplug the USB.

Measurement configuration (single USB stick used for different loggers)

- ▶ Copy the file **TSTdrive.mcf** to the root directory on the USB stick.
- ▶ Power up the logger and wait for the yellow LED which indicates data acquisition.
- ▶ Plug in the USB stick to the logger, configuration update will start automatically. The TSTdrive.mcf will remain on the USB stick, whether the update has been completed successfully or not.
- ▶ Wait until the yellow LED lights no longer and unplug the USB.
- ▶ Repeat this procedure for any other logger update relating to this configuration

Serial number specific update

When updating via USB/FTP, the system checks, if the file name consists of a 8 digit serial number. Update is executed when the serial number matches with the logger, the file is deleted from the source directory afterwards. In case of mismatch, the latest valid file is used. Files with invalid serial numbers will remain in the source directory.

When the file contains no serial number information, the standard update process is executed (equal to previous TESTdrive versions).

3.3.11 TESTdriveCMD.xml

The file TESTdriveCMD.xml controls user access of the logger. If the restriction has been activated, the logger searches for the TESTdrivecmd.xml at the root directory of the USB stick. Measurement will not be started when the file is missing.

Activate the use of the TESTdrive commands at IPEmotion **Options > Plugins > IPETRONIK LOG >**

Settings  **> Options > Activate TESTdrive access restriction.**

The following templates are located at:

...\IPETRONIK\IPEmotion PlugIn IPETRONIK
LOGV03.xx.00\Data\TESTdriveCMD\[language]

Guest (directory „guest“)

- ▶ Copy data
- ▶ External storage

User (directory „user“)

- ▶ Update measurement configuration
- ▶ Update measurement configuration, Copy data
- ▶ Update measurement configuration, Copy data incl. PostMortem
- ▶ Update measurement configuration, Move data
- ▶ Update measurement configuration, Move data, incl. PostMortem
- ▶ Start logger in FTP mode
- ▶ Set the logger's system time

Administrator (directory „admin“)

- ▶ Update measurement application
- ▶ Update measurement application, Delete data
- ▶ Update measurement application, Update measurement configuration, move data
- ▶ FPGA update

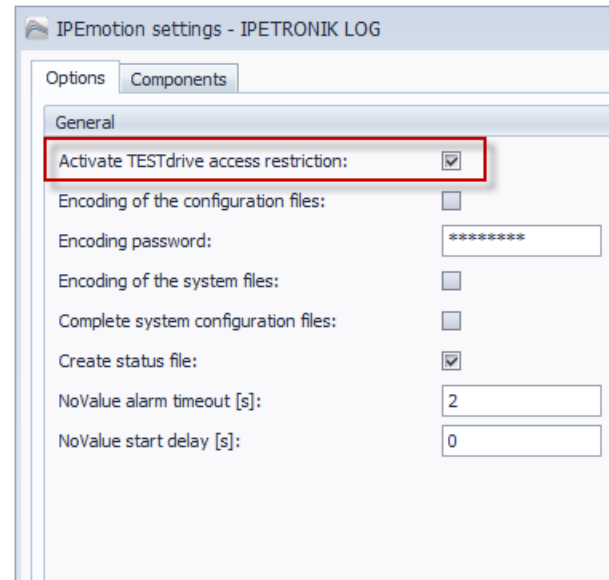

Parameter of the “dataTransfer” service

<meaNumber>

If this parameter has not been defined, all data will be transferred. Valid values of this parameter are "all" (not case sensitive) and a number between 0 and 9999. This parameter can be used multiple times. The applied sequence has no effect on data transmission. The data transfer starts with the measurement data file named with the lowest number in ascending order.

The file TESTdriveCmd.xml will be deleted from the server as soon as it has been transferred successfully. It will be deleted from the local source if all <meaNumber> entries have been processed. The file name prefix "TESTdriveCmd" is required, the file extension has to be ".xml". If the file name consists of an 8 digit number (e.g. TESTdriveCmd_12345678.xml) the logger will take this as serial number. The file will be accepted only if the serial number from the file name fits to the logger's serial number. If not, the file will be ignored and remains on the FTP server.

The existing parameters <zip>, <crypt>, <split>, <move> and <useTimeDir> will be ignored. They will be considered only if this service is applied by a USB stick. In this case, the TESTdriveCmd.xml remains unchanged, as usual before and it will not be deleted.

<transfer>

This parameter controls the data transfer following to the data post processing (zipping, splitting, copying). Valid values are "true" and "false". If the parameter is not configured, its value is set to "true" per default.

"true" Zipped and splitted (if required) files are copied to the USB stick.

"false" No measurement data is copied to the USB stick.

4 External connection

4.1 Grounding



It is absolutely necessary to connect the logger case with a suitable ground pin within the overall system. Without this grounding, EMV disturbances and uncontrolled voltage interferences can restrict the measuring process.

4.1.1 IPElog, M-LOG grounding connection

IPElog and M-LOG provide a grounding tap by a blade terminal. Use a 6.3 mm blade receptacle to connect the grounding tap.

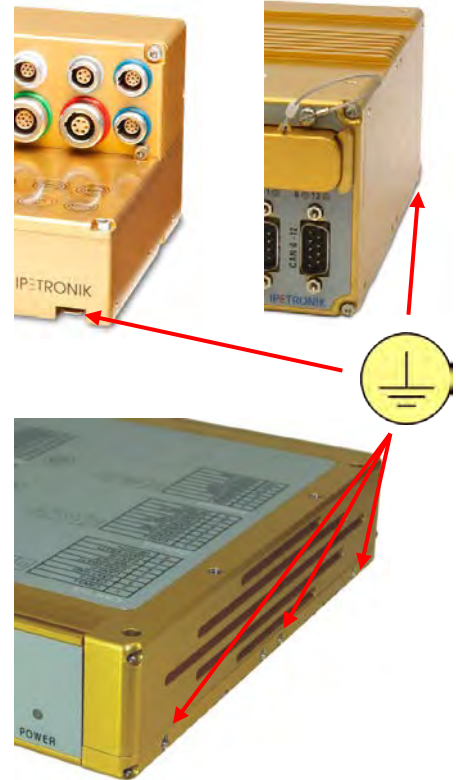

4.1.2 FLEETlog grounding connection

FLEETlog2 has four M4 threaded holes at each side which are used to tighten the mounting brackets. We recommend to use an appropriate ring tongue terminal with one of the side screws for grounding the logger case. A fork tongue terminal can also be used.

4.2 PWR / Remote connection

4.2.1 PWR/REM cable 620-574

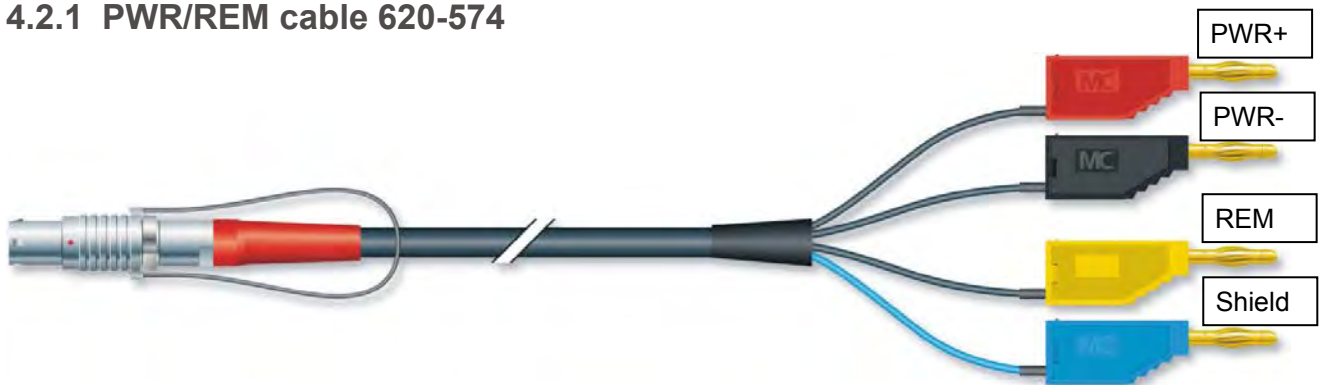

Always switch on and off the logger using the REM (ignition line 15) connector, never by switching the PWR+ line!

Never disconnect the PWR- (GND) line while the logger is running, because this will damage electronic circuits. Switching-on/off the logger via PWR- (GND) is absolutely not allowed!

4.2.2 Remote connection

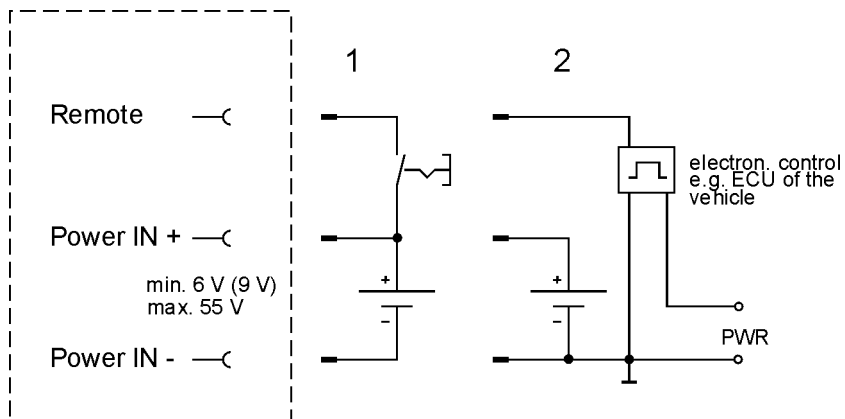

The logger has internal buffer capacitors to avoid a data loss due to sudden voltage losses. The regular shut-down is executed via remote and not by switching-off the excitation!



The activating via a remote impulse (impulse length > 20 ms) is also supported. But the continuous remote signal must be received within 60 s, otherwise the logger is shut down by the watchdog.

Example:

Start of measuring system with opening the vehicle door. The continuous remote signal is received at motor start and the system continues measuring. If the continuous signal is not received (no motor start), the logger shuts down after 60 s.

4.3 Digital input/output connection

LOG-PWR switched logger excitation (not stabilized)
The excitation is supplied, as soon as, the logger is activated.

4.3.1 Connecting example digital input

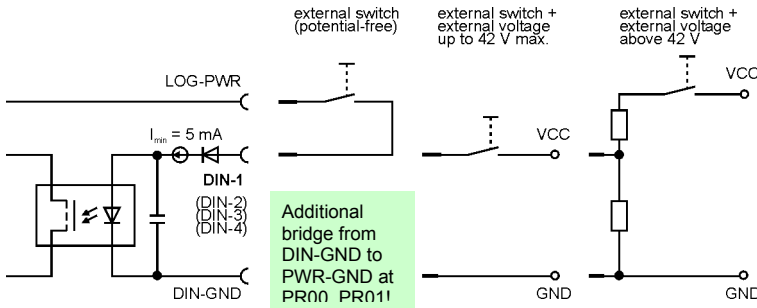

potential free contact with external excitation up to 42 V without any resistor or voltage divider

Terminal 15 of the board electrics (all vehicle power supplies up to 42 V without any resistor or voltage divider)



The digital inputs are electrically isolated but the respective DIN-GNDs are all connected to one PIN of the Sub D socket! This PIN has a direct connection to PWR-IN GND with the PR03, PR04, PR05, PR06 port replicators!

The inputs are protected by an internal 5 mA current limitation.

Required minimum values at the input for a clean functionality:
 $U_{min} = 3 \text{ V}$ bzw. $I_{min} = 2 \text{ mA}$

4.3.2 Connecting example digital output

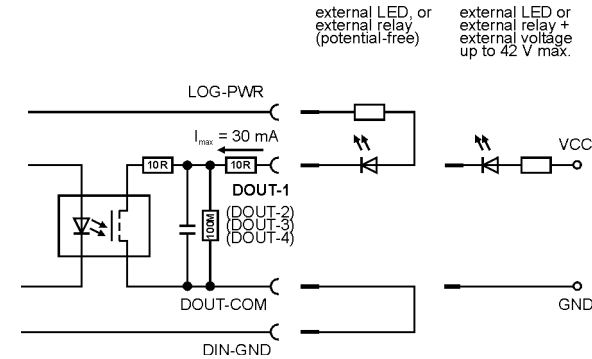

GND (ground) switched
 $R_i = 20 \Omega$

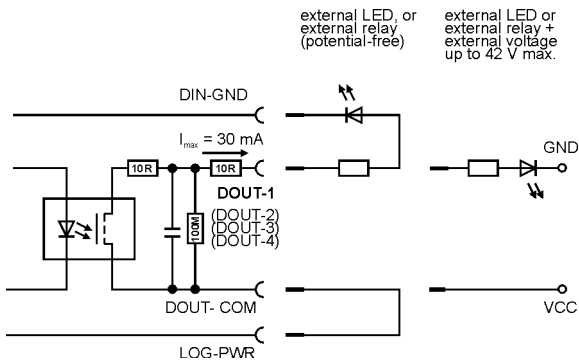

V+ (excitation) switched
 $R_i = 20 \Omega$



The digital outputs are electrically isolated and can operate bipolarly but the respective COM ports are all connected to one PIN of the Sub D socket!

4.3.3 Connecting example external status LED

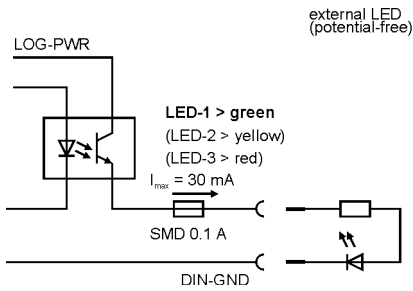

4.4 Bus inputs

4.4.1 Connecting example CAN bus

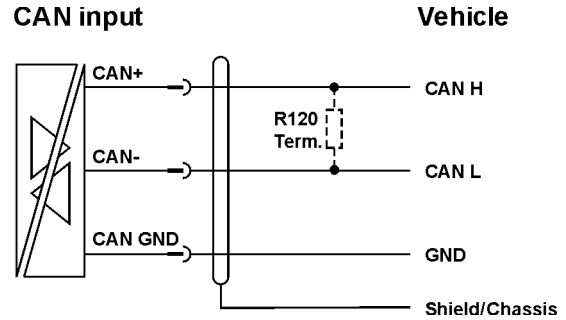

4.4.2 Connecting example LIN bus

Due to the galvanic isolation, the transceiver of the LIN measurement input must be power supplied by an external source. This can be:

1. Connection of the vehicle's bus power supply ($V_{Bsupply}$) or
2. Connection of the logger's power supply (bridge from PIN 5 to PIN 1)

Variant 1: Connect V_B of the external LIN bus

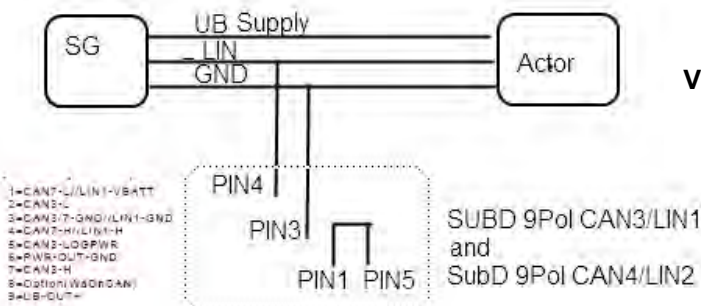
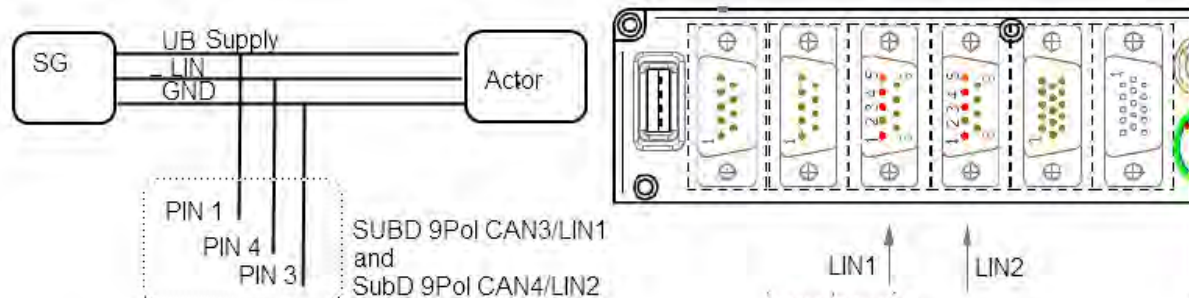

Variant 2: Supply via logger (bridge from PIN 5 to PIN 1)

5 Configuration with IPEmotion (extract)

The IPEmotion software is required for configuring a logger measuring system and the corresponding IPETRONIK devices. The software must be installed on the notebook/PC, which is used to configure. (See the instructions in [Commissioning](#)). IPEmotion also supports the online data measurement with using the XCP service. You can find a detailed description of IPEmotion in the manual, which can be opened in the software as a PDF.

5.1 First steps

5.1.1 Main dialog

After the start of IPEmotion, the following screen appears.

The screenshot shows the IPEmotion software interface. At the top, there are 'Main Navigation Tabs' (File, Project, Signals, Acquisition, View, Data manager, Analysis, Reporting, Scripting, Info) and a 'Quick Access Bar' with icons for System, Components, Import, Export, Check, Adjust, Detect, Initialize, Display, and Details. The main window is divided into several sections: a left sidebar with a tree view of hardware components (CAN, DIN, DOUT, USB, ETH, COM, Audio, Display, Logger processing, Status, Storage groups), a central table of signal configurations, and a bottom section for detailed configuration of the selected signal.

Name	Active	Unit	Phys Min	Phys Max	Sensor Min	Sensor Max	Sampling rate
DIN 01	<input checked="" type="checkbox"/>		0	1	0	1	1 Hz
DIN 02	<input checked="" type="checkbox"/>		0	1	0	1	1 Hz
DIN 03	<input checked="" type="checkbox"/>		0	1	0	1	1 Hz
DIN 04	<input checked="" type="checkbox"/>		0	1	0	1	1 Hz
DOUT 01	<input checked="" type="checkbox"/>		0	1	0	1	1 Hz

The 'Main window at selected tab "Signals"' shows configuration details for 'DOUT 04':

- Active:
- Name: DOUT 04
- Description: Digital output
- Reference: DOUT 04/80002763
- Sampling rate: 1 Hz

The 'Message window' at the bottom shows a message: '01.08.2013 17:09:28,397 INFORMATION Import: No baudrate was s'.







IPEmotion automatically detects all available hardware connections at starting.

*If you want to reduce the required time, select **Options > PlugIns** for deactivating those interfaces, which are not used.*

5.1.2 The Title Bar

The title bar contains the quick access bar, the software name, as well as, a tool bar with the following functions:



-  Help – Open the documentation IPEmotion.pdf where you can find useful information for a safe and clean application of the software.
-  Minimize – Minimize the application window of IPEmotion and place it in the task bar of your desktop.
-  Maximize – Make the application window visible on your desktop and refit the prior size.
-  Close – Close the application of IPEmotion.

5.1.3 The file menu

The file or application menu contains basic functions as: **New, Open, Save, Save As, Runtime version, Print** and **Close**, as well as, further properties such as **View, Options, Support file** and **About**.

The right partial view of the application menu contains a list of the recently used projects.

The **View** function contains the menu points **Message window** and the **Reset** command. Show or hide the message window and reset the displaying configuration to the default parameters.

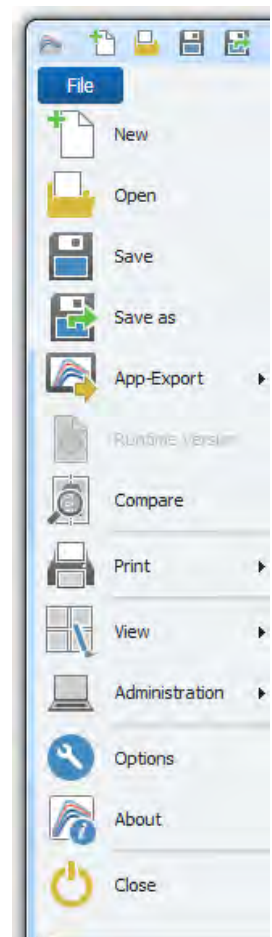

5.1.4 Using the options

With the Options entry, you have the ability to edit user defined settings. You can define the following options:

- ▶ Frequently used
- ▶ Basic settings
- ▶ View
- ▶ Data manager
- ▶ Analysis
- ▶ Units
- ▶ PlugIns

The following section offers you a detailed overview over the available setting options.

Frequently used

Activate or deactivate **Start with the latest configuration** and define the settings for the **automatic hardware detection**. Activate or deactivate the **automatic hardware detection at start** of IPEmotion and select a possible **standard command after successful detection**:

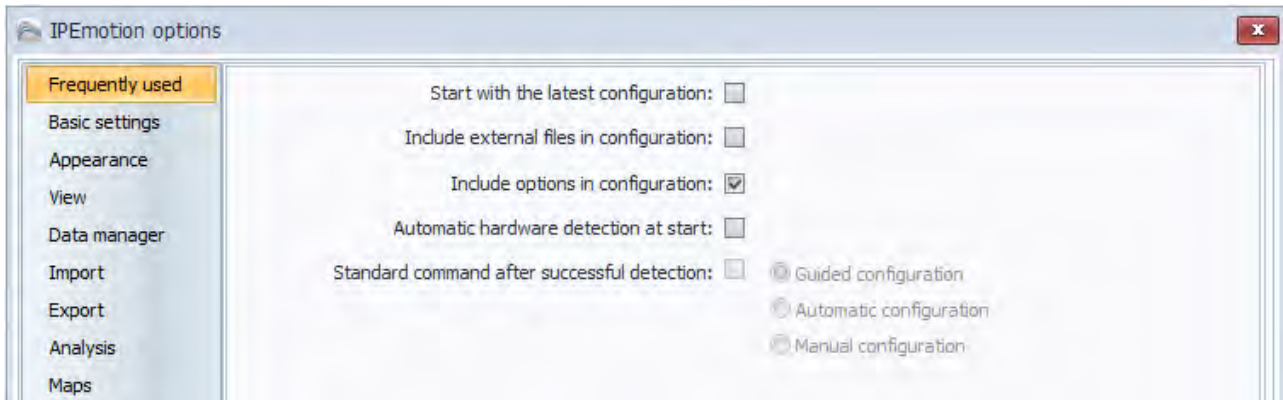

Basic settings

Select a **preferred configuration type**: Hardware configuration or signals configuration

Activate or deactivate the options: **Accurate acquisition chain required** and **Expert mode**.

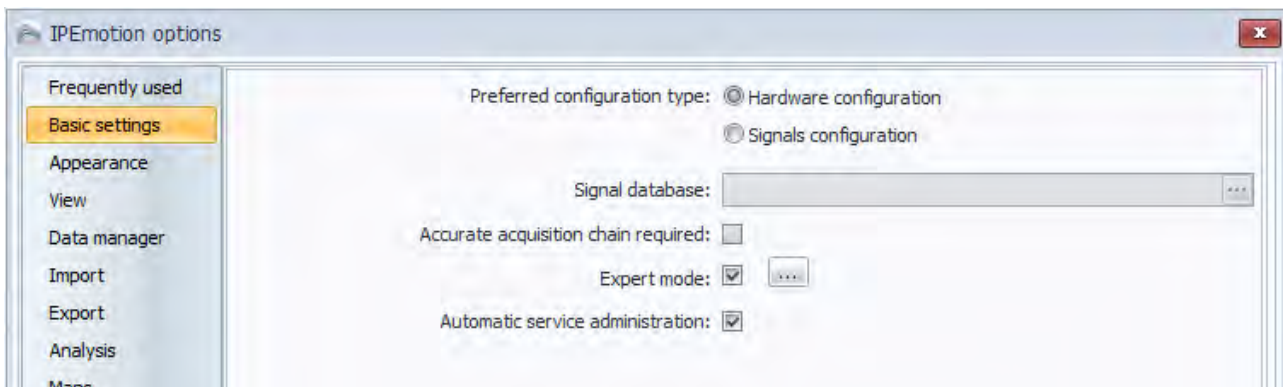

Expert mode

The protocol nodes of imported description files (CANdb, A2L, FIBEX,...) are visible, this means, the user has access to the signal properties. With the protocols CCP and XCP the DAQ lists are displayed and can be processed (delete, move signals).

With the release of IPEmotion V01.07.00 internal channels (-> Variables) for temporary storage tasks have been implemented. Managing this variables is only supported with an enabled Expert mode.

Activate the **Automatic service administration** option to automatically import the active channels into the DAQ lists of the XCP service. These channels are then available in online view.



Please note the restrictions depending on the Ethernet interface of the PC and the number of active channels. In this case, it is recommended to manually import the required channels into the DAQ lists of the XCP service (deactivated Automatic service administration)

View

Define your **view settings** according the following listed points:

Language selection

Skin selection

Displaying tooltips

Font size of the visual elements

Transparency of configuration dialogs (0 – 30 percent)

Activate or deactivate the use of the **Windows standard dialogs** for the file and directory selection.

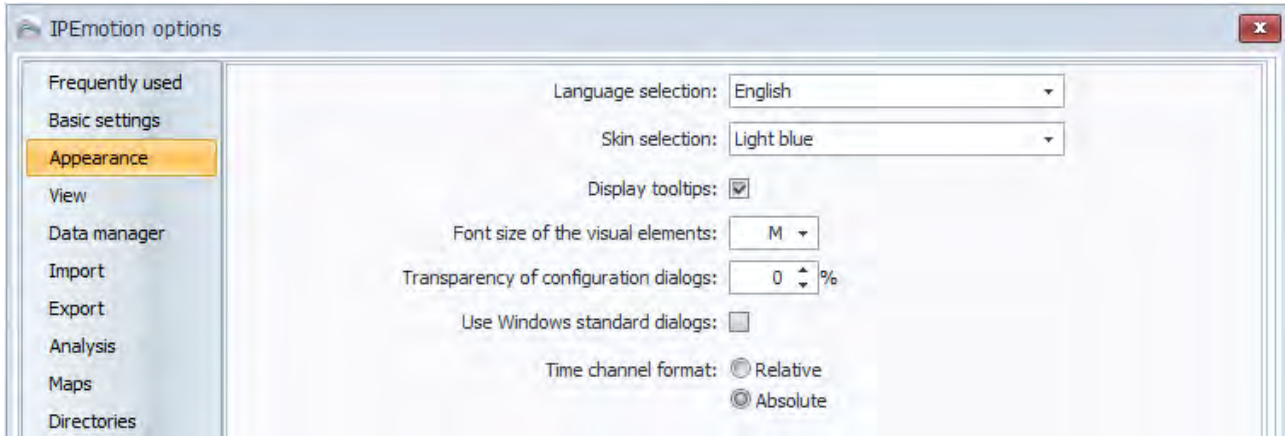

Data manager

Define the **Time channel format** as *Relative* or *Absolute* (This setting is currently not supported for the export into external formats!) and activate or deactivate the option: **Merge time channels with equal acquisition rate**.

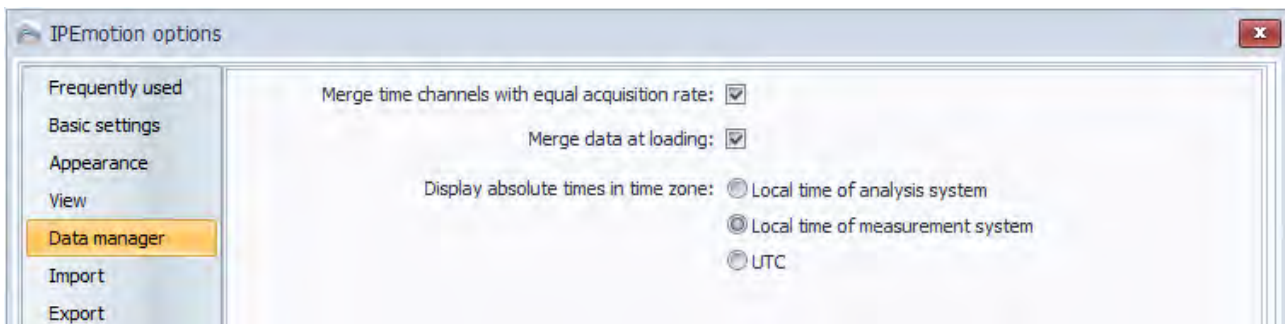

Analysis

Select the **points per diagram graph**. Define if all signals are considered in the analysis diagrams at drawing the graph or only the samples. Move the bar accordingly to the preferred speed or quality.

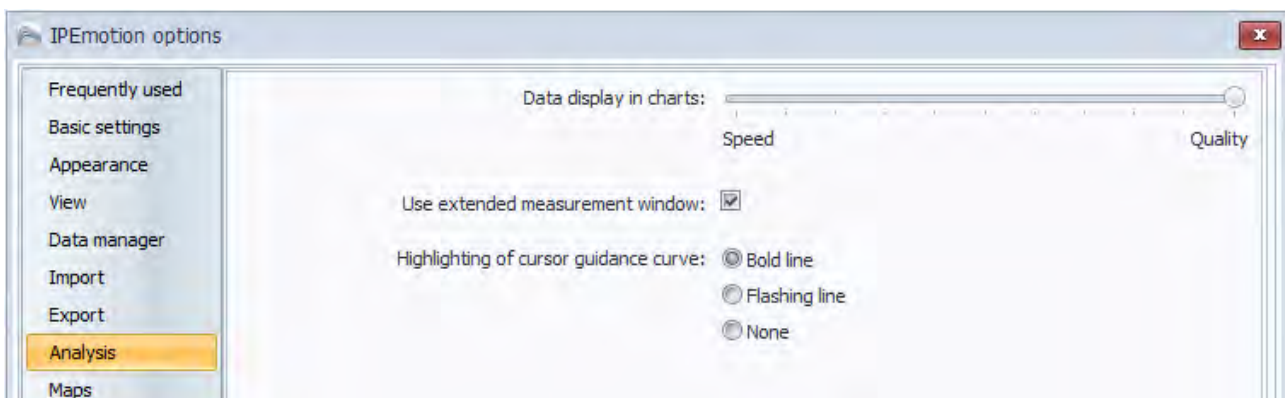

Units

Get an overview according the common physical values and their respective unit and edit them.



Activate this PlugIn for all logger applications.
The corresponding TESTdrive version must be available at the logger!

PlugIns

Activate or deactivate the **hardware systems** to be used.

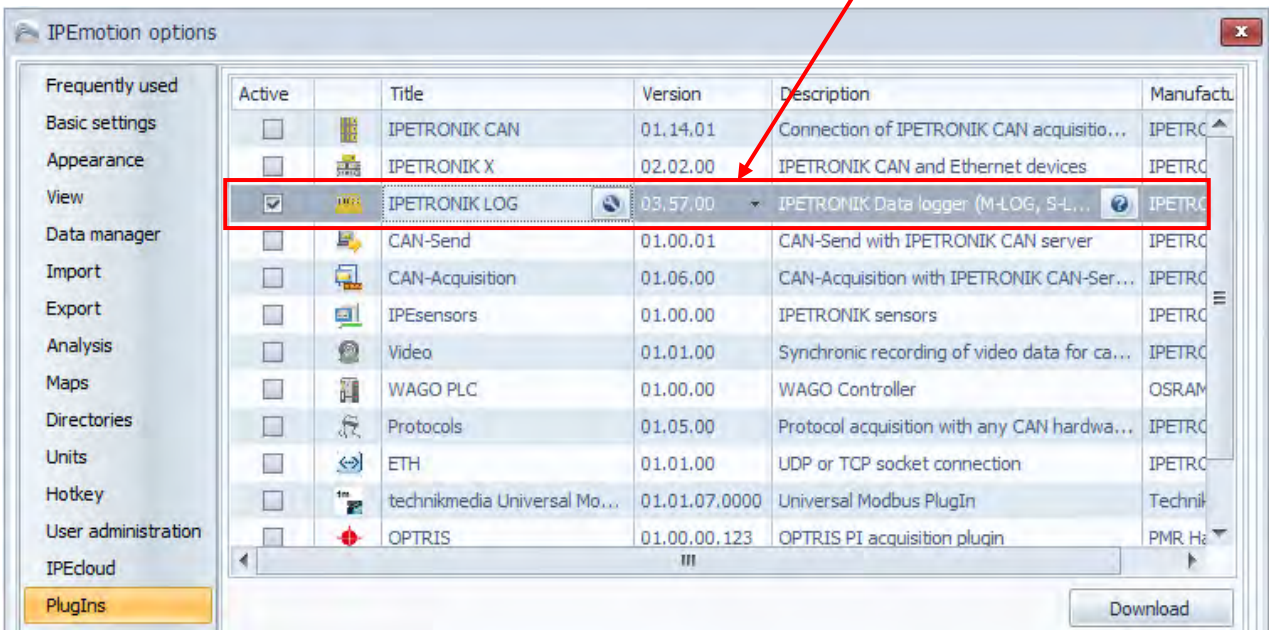

Clicking the wrench symbol  enters the dialog for PlugIn specific settings provided by the tab **Options** and **Components**.

Components

With the **Settings** button, you have the ability to define the **components** (module type and priority, e.g. for the type selection of the Dry configuration) of the respective hardware system and to edit additional **options** settings.

The selection of the hardware components for the configuration by using a signal library is based on the **Priority**. This preselection with a priority assignation of the system components facilitates the device selection and improves the system speed.

The **High** priority defines a preferred use of the corresponding hardware component at configuring with a signal library. The hardware components, which are defined with the **Not used** priority, cannot be selected for an acquisition.

Options

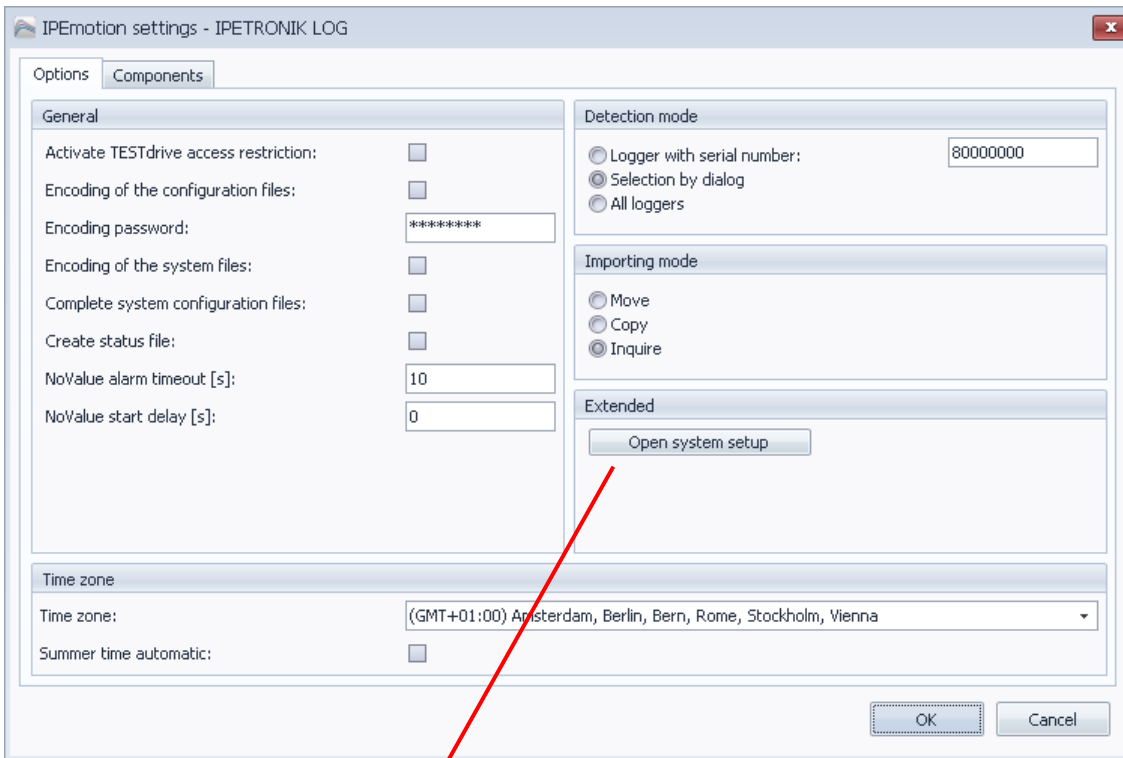

Extended options

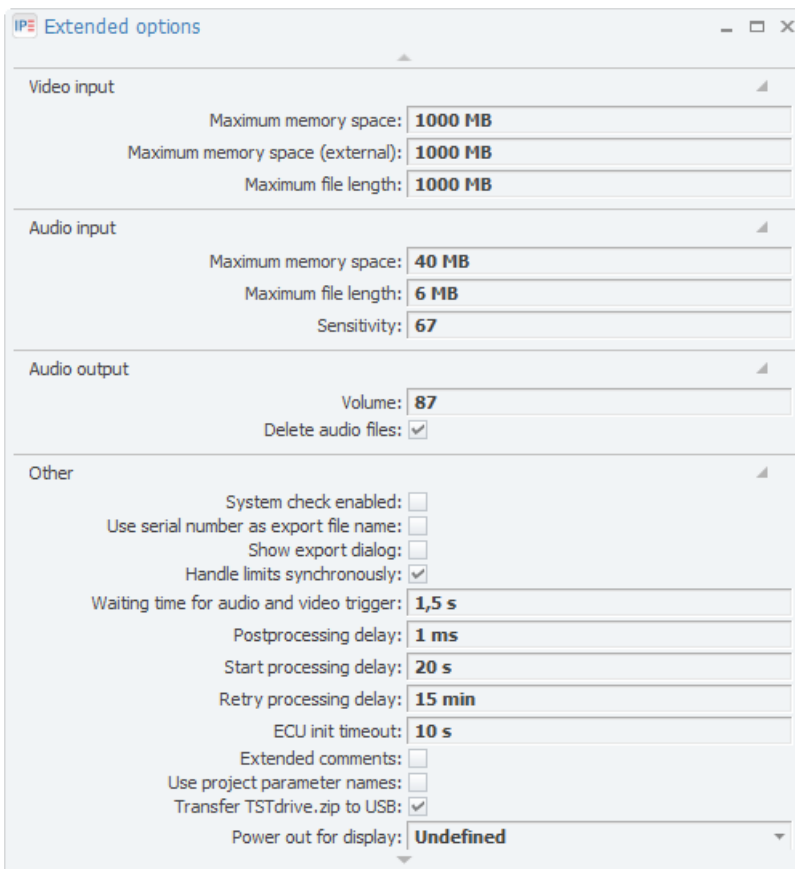

Activating this check box will execute an automatic CAN ID assignment starting with the predefined ID for connected and identified modules.

Data transmission rate settings
slow: 1 ... 5 Hz
medium: 10 ... 50 Hz
fast: 100 ... 1000 Hz

5.1.5 Creating a support file

With the **Support file** entry of the application menu, you have the ability to create a support file and add and/or edit own comments and error descriptions.

Enter in the appearing **Create support file** screen an error description. Accept the default location for the file. To select another location click on the  symbol.

After you have specified the location and a user defined file name, click **Save** to return to the **Create support file** screen.

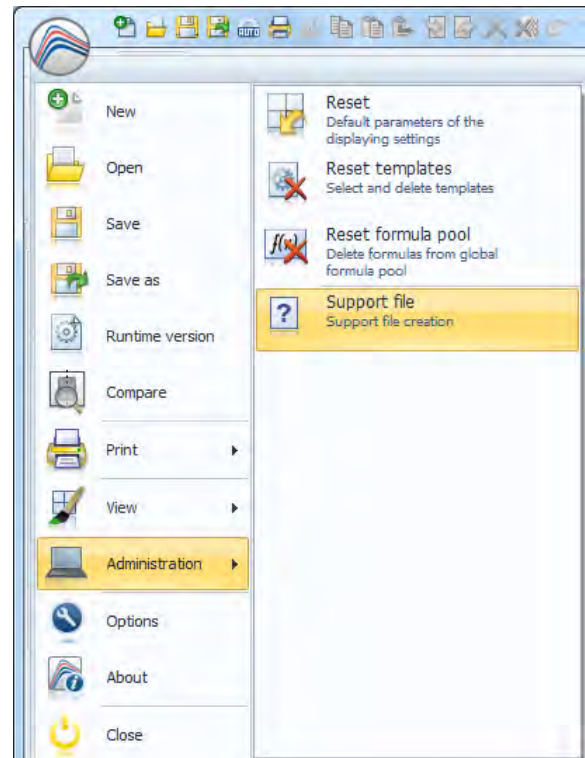
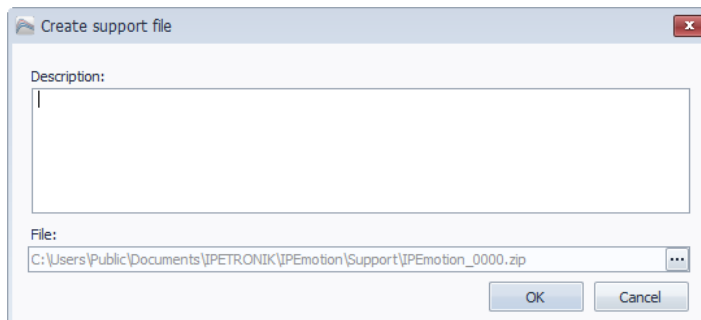

After clicking on **OK** a zip file is generated that contains the error description, as well as, the following information:

- ▶ System information (Windows version, computer name, free memory on the local drives, ...)
- ▶ Current configurations (acquisition, online view, script configurations)
- ▶ Trace files (.NET, C++)

If you have any problems while working with IPEmotion, send us this support file at support@ipemotion.com.

5.1.6 IPEmotion working areas (main navigation tabs)

The main navigation tabs allow a quick activation of the different main functions of IPEmotion. A tab displayed in light blue indicates an active function.

IPEmotion is designed to follow the main navigation tabs from left to right. Use this reasonable order like a read thread, which guides you step-by-step to a successful acquisition.

Project	Signals	Acquisition	View	Data manager	Analysis	Reporting	Scripting	Info
----------------	----------------	--------------------	-------------	---------------------	-----------------	------------------	------------------	-------------

- Project** Define your general user defined project data.
- Signals** Configure the connected acquisition systems and modules.
- Acquisition** Configure the desired storage groups and channels.
- View** Take a measurement defined by the connected hardware modules and the set configurations.
- Data manager** Manage your stored acquired data in all the supported formats.
- Analysis** Visualize your channels with diagrams.
- Reporting** Create reports and project documentations.
- Scripting** Automate your acquisition sequences.
- Info** Get a basic overview and general support.

Project

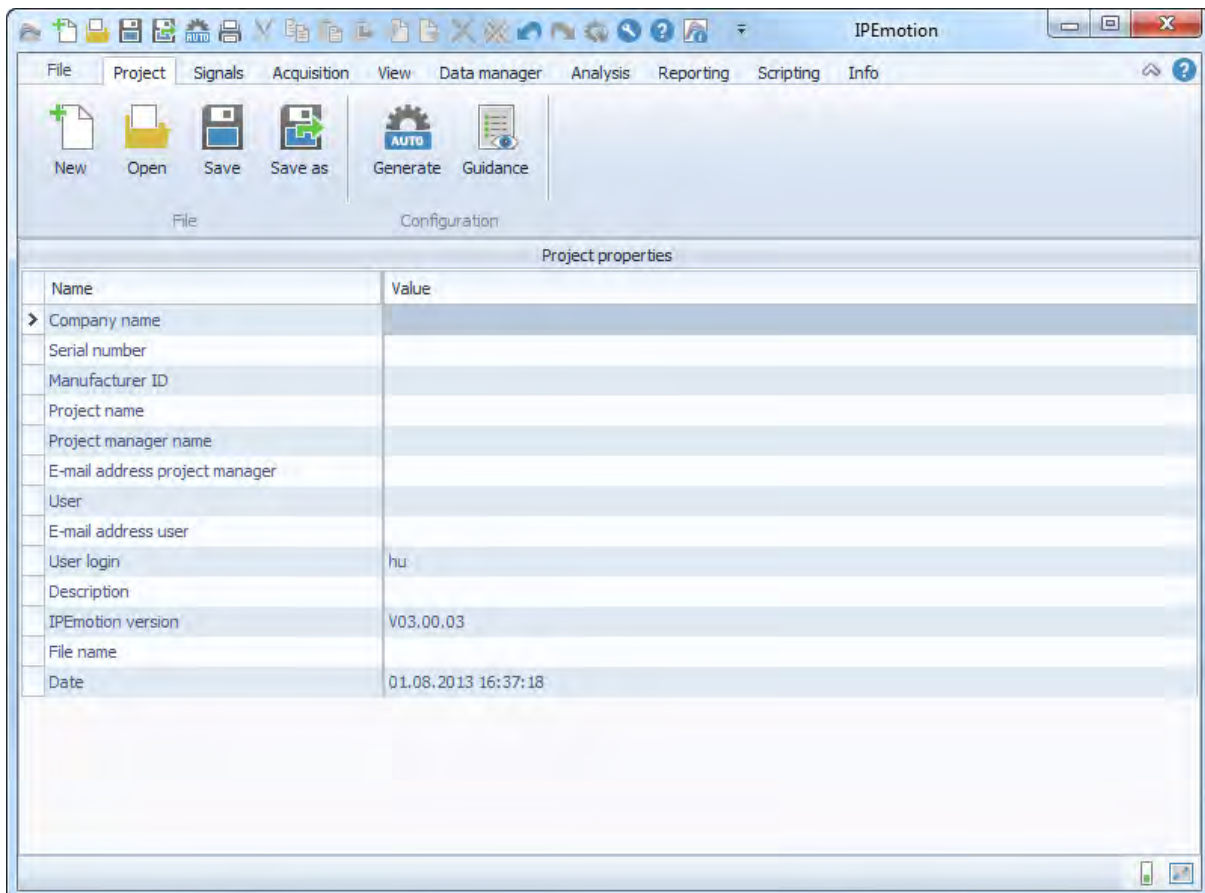

Signals

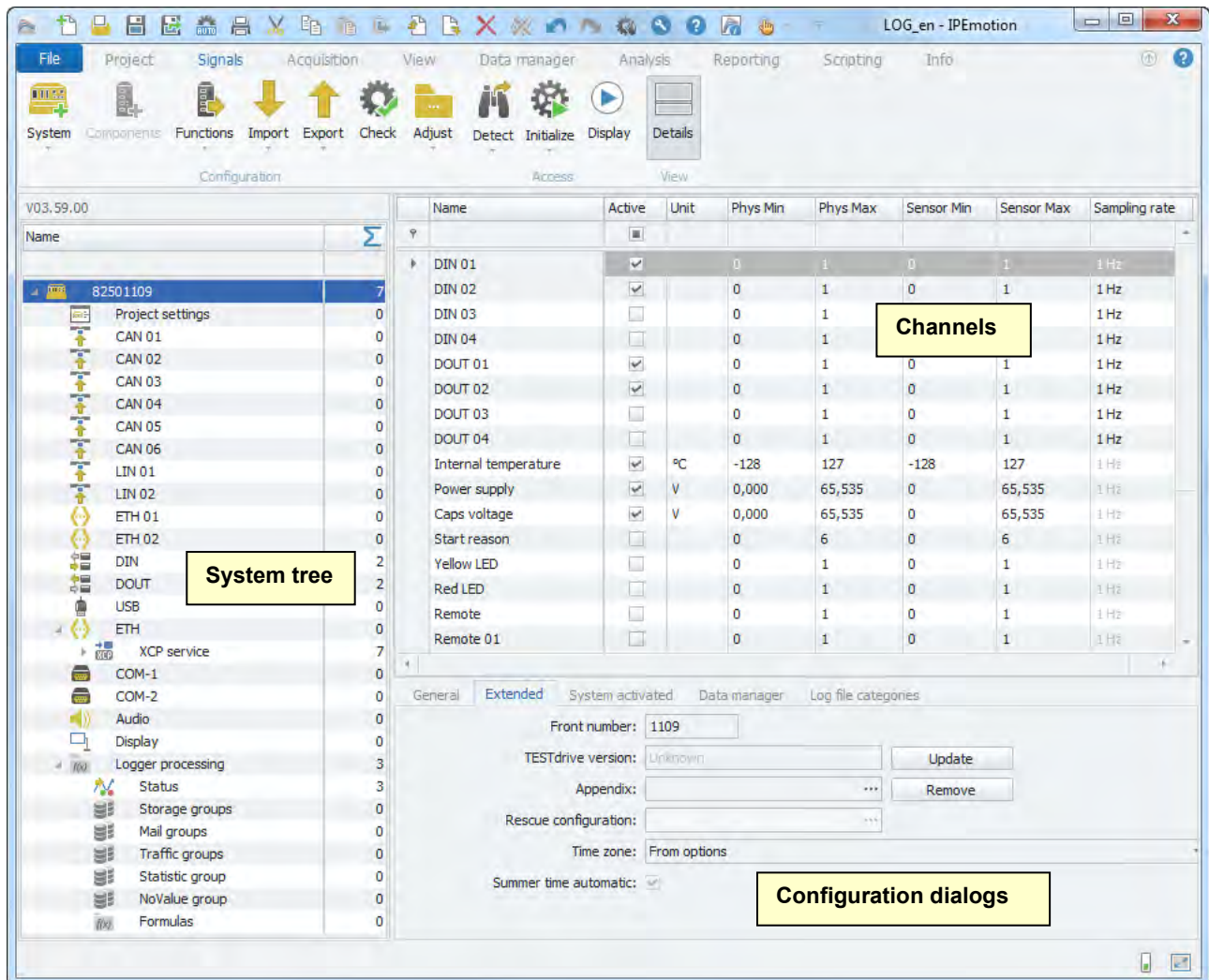

5.1.7 Info

The chapter offers a basic overview of the IPEmotion software. In addition, it shows useful advices and tips and tricks on how to use IPEmotion.

The view Info is divided into the following menu points:

- ▶ Welcome
- ▶ Release Notes (only in English)
- ▶ Red thread
- ▶ Tips and tricks
- ▶ Keyboard handling
- ▶ Documentations
- ▶ Contact and support

5.2 Logger settings

General

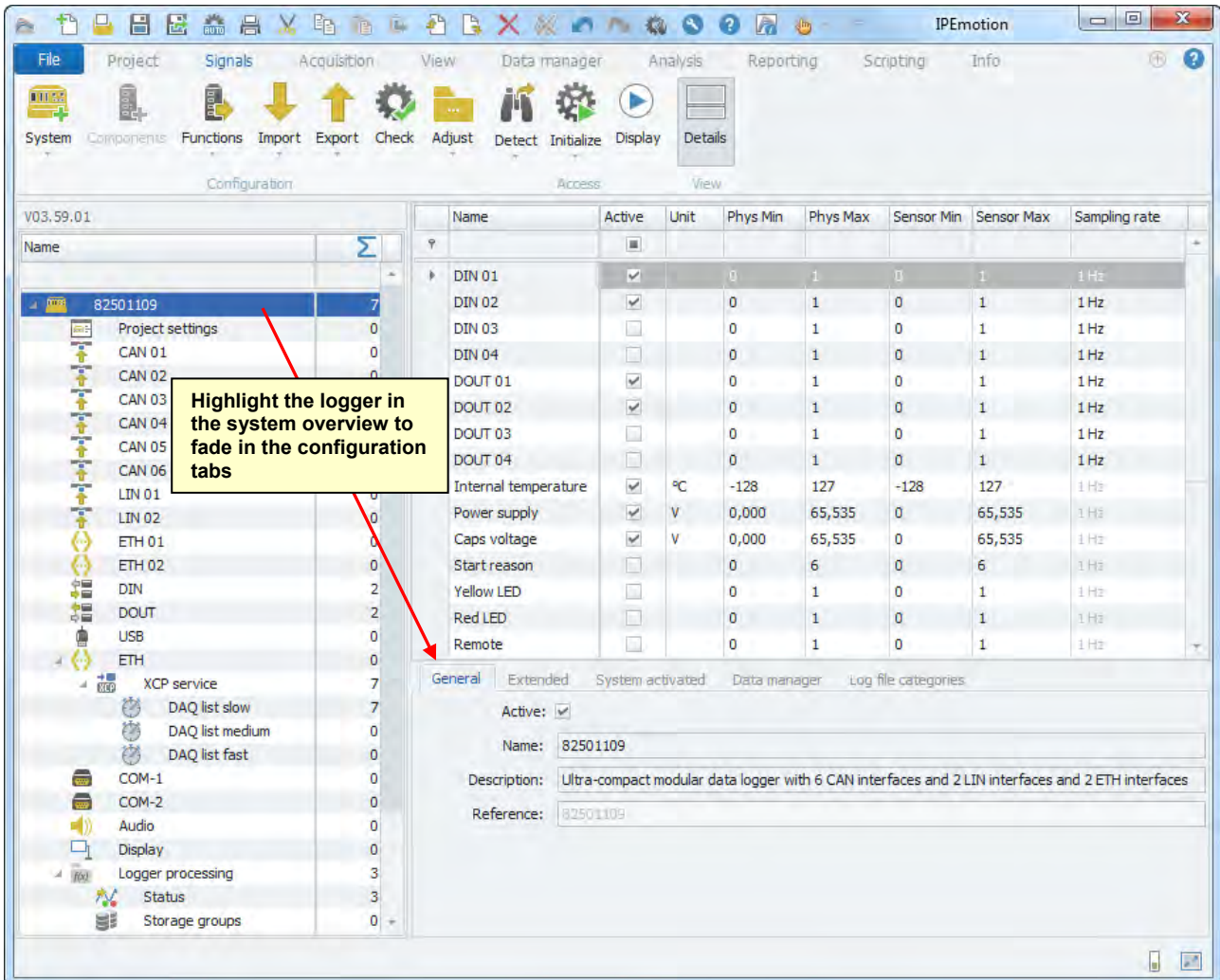

Extended

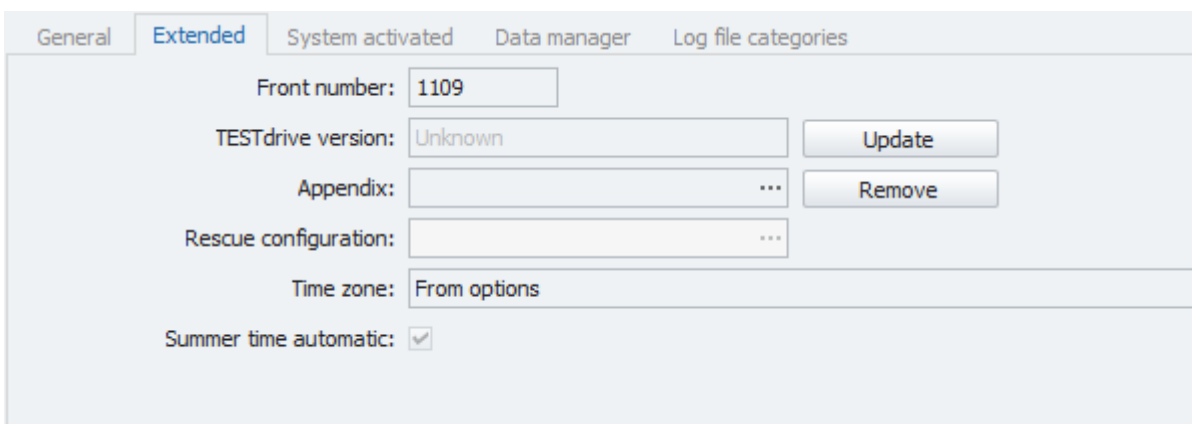

- Front number:** The last four digits of the logger serial number.
- TESTdrive version:** Version of the TESTdrive application running on the logger. With a hardware detection through a LAN/WLAN connection, the current version is indicated. A mouse click to **Update** will upload the latest version.
- Appendix:** Transfer a user specific file to the logger.
- Rescue configuration:** Store rescue configuration on the logger (fall back)
- Time zone:** Applying the PlugIn settings defined under **Options > PlugIns > PlugIn-specific settings > Time zone**
- Summer time automatic:** Automatic switch-over winter time <> summer time

System activated

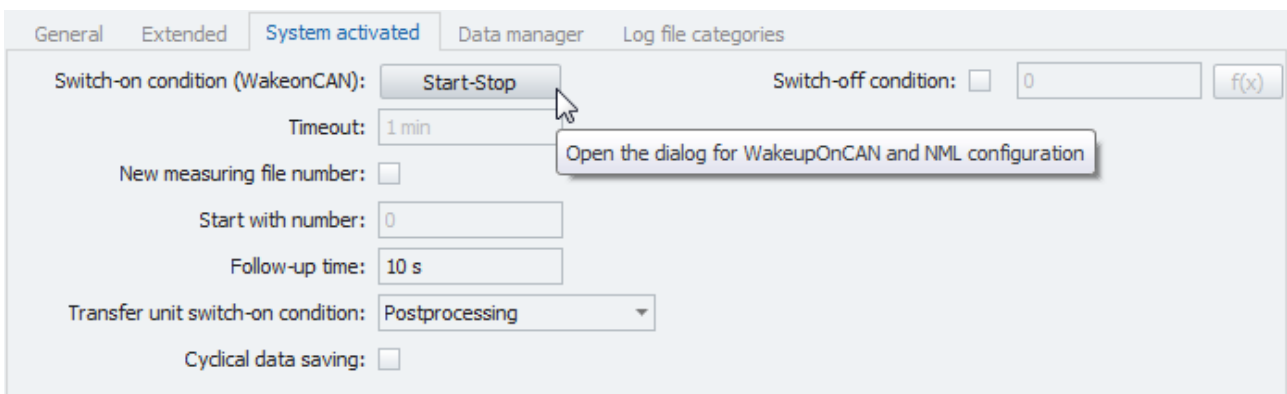

- Switch-on condition (WakeonCAN):** Selecting the CAN bus(es) to be used for boot up the logger by the WakeonCAN feature.
- Timeout:** The logger waits this period for the remote signal resp. bus activity.
- Switch-off condition:** User defined condition (trigger, formula) to be used to switch-off the logger. In case a remote signal (REM = ignition line 15) is still high, the logger will shut down and power up again.
- New measuring file number:** Consecutively numbering of measurement data files beginning with the predefined start number.
- Start with number:** Start number for the consecutive measurement file numbering
- Follow-up time:** When the switch-off signal has been identified, the logger waits this period (and keeps on operating) before shut down.
- Transfer unit switch-on condition:** Switch on the WiFi client respective the modem for wireless data transfer by the logger.
- Cyclical data saving:** Acquired data is continuously stored to the measurement data file (not only by stopping the measurement).

Data manager

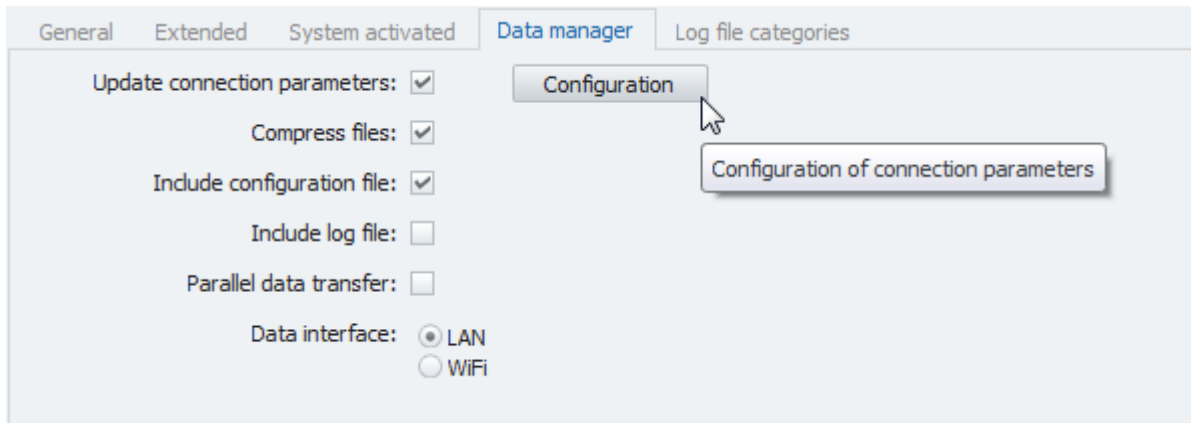

Update connection parameters:

Enables the access to connection parameters settings by use of the **Configuration** button.

Compress files:

Activated the compressing of measurement data files

Include configuration file:

Includes the DAQ configuration (**CFG_XXX.isf**) in the measurement data zip file **XXX_MEA_XXX.zip**.

Include log file:

Includes the DAQ log file (**MEA_XXX.log**) in the measurement data zip file **XXX_MEA_XXX.zip**.

Parallel data transfer:

Enables data transfer simultaneous to a running data acquisition

Data interface:

Selection of the communication interface (LAN, WLAN)

Log file categories

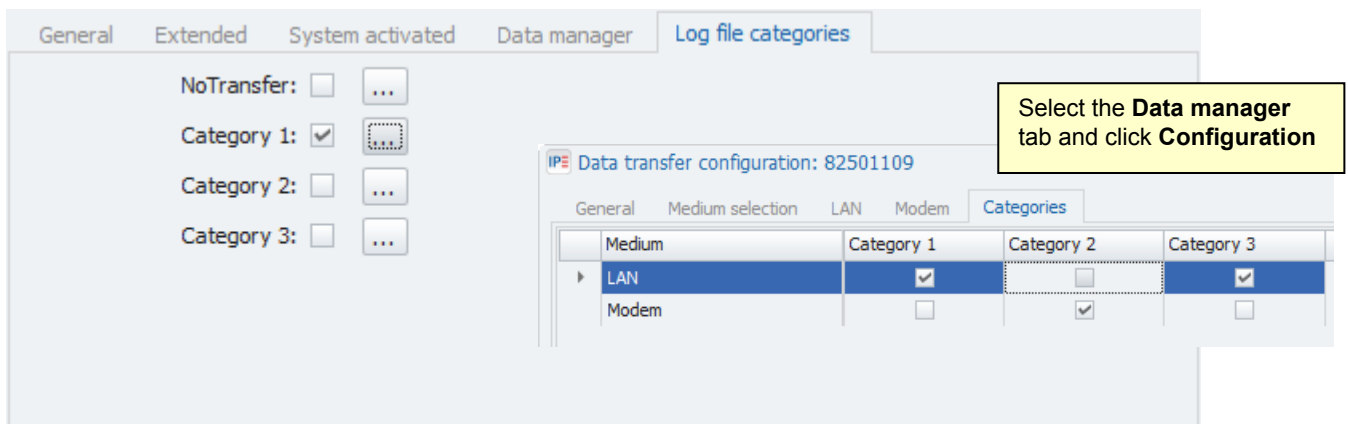

NoTransfer:

Exclude selected data from transfer.

Category 1:

Assign storage groups, log file, ... to the data transfer category #1

Category 2

Assign storage groups, log file, ... to the data transfer category #2.

Category 3:

Assign storage groups, log file, ... to the data transfer category #3



Data groups can be linked with a single or multiple data transfer categories.

Although a single or multiple data transfer categories can be assigned to a data transfer medium (LAN, modem), a specific category can be assigned to a single medium only.

6 Basic functions

6.1 Switching-on / switching-off

Description of the supported switching-on / switching-off modes

6.1.1 Ignition line 15

Remote 1 (Ignition line 15)

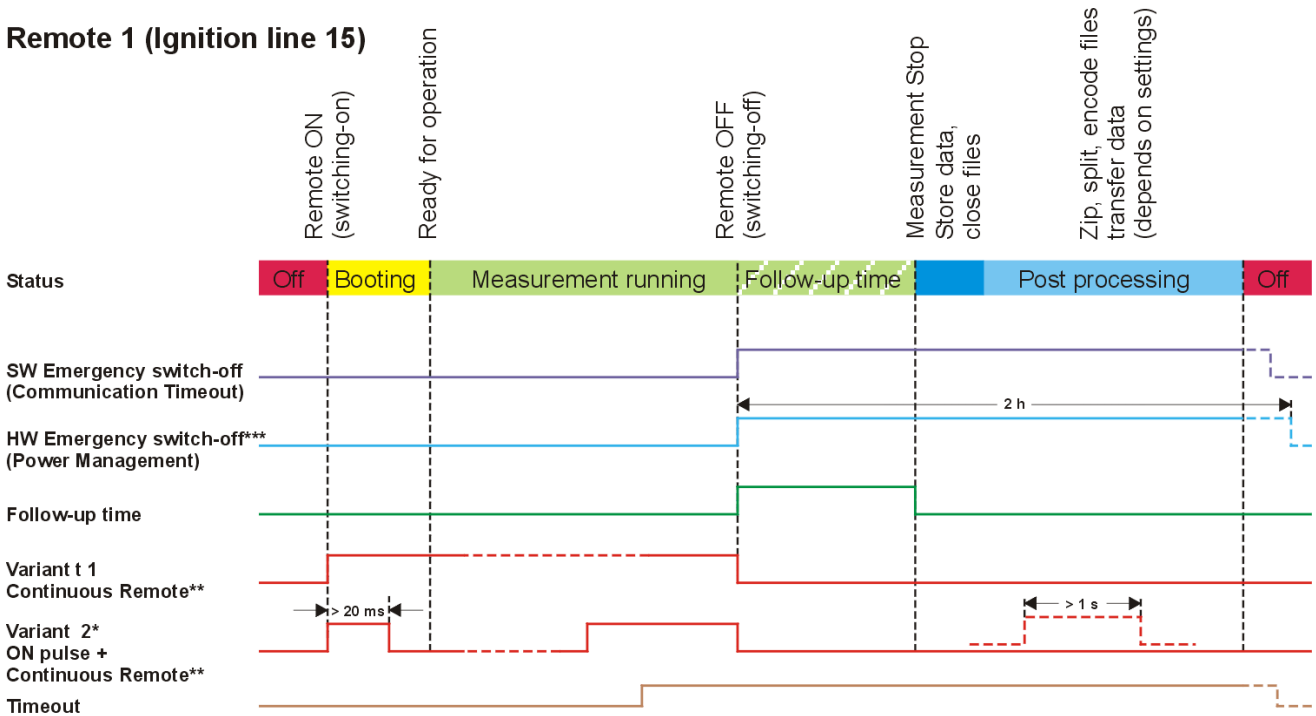

*Variant 2: Switch-on condition (WakeOnCAN) enabled, continuous remote signal required before timeout expires

**Conitnuous Remote: If a remote signal (duration > 1 s) is identified during post-processing, the logger will stop this task and start a new acquisition.

***HW Emergency switch-off: The logger will be absolutely switched-off by the power management 2 h after the previous falling edge of the remote signal.

6.1.2 WakeOnCAN

WakeOnCAN, Ignition line 15

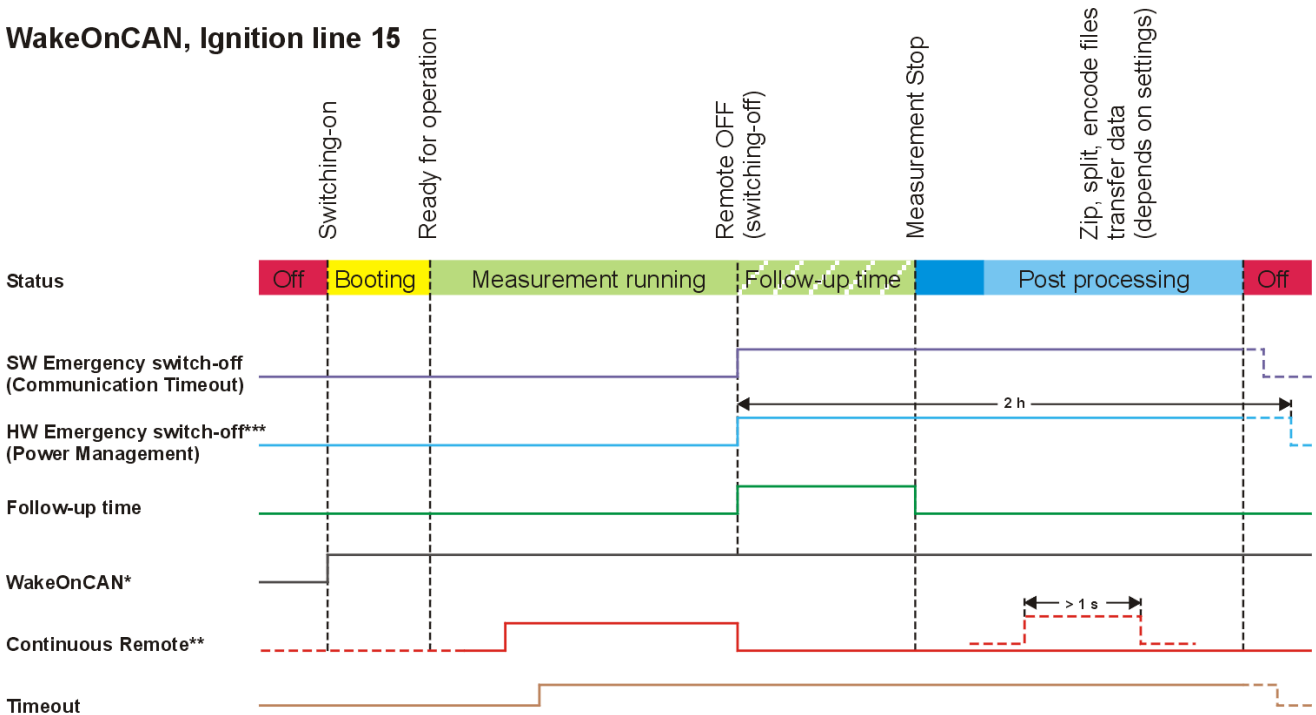

*WakeOnCAN Ign. 15: Switch-on condition (WakeOnCAN) enabled, continuous remote signal required before timeout expires jumper Pin 3-6 and Pin 8-9 at respective CAN input to indicate bus traffic (WakeOnCAN)!

**Continuous Remote: If a remote signal (duration > 1 s) is identified during post-processing, the logger will stop this task and start a new acquisition.

***HW Emergency switch-off: The logger will be absolutely switched-off by the power management 2 h after the previous falling edge

WakeOnCAN without Ignition line 15

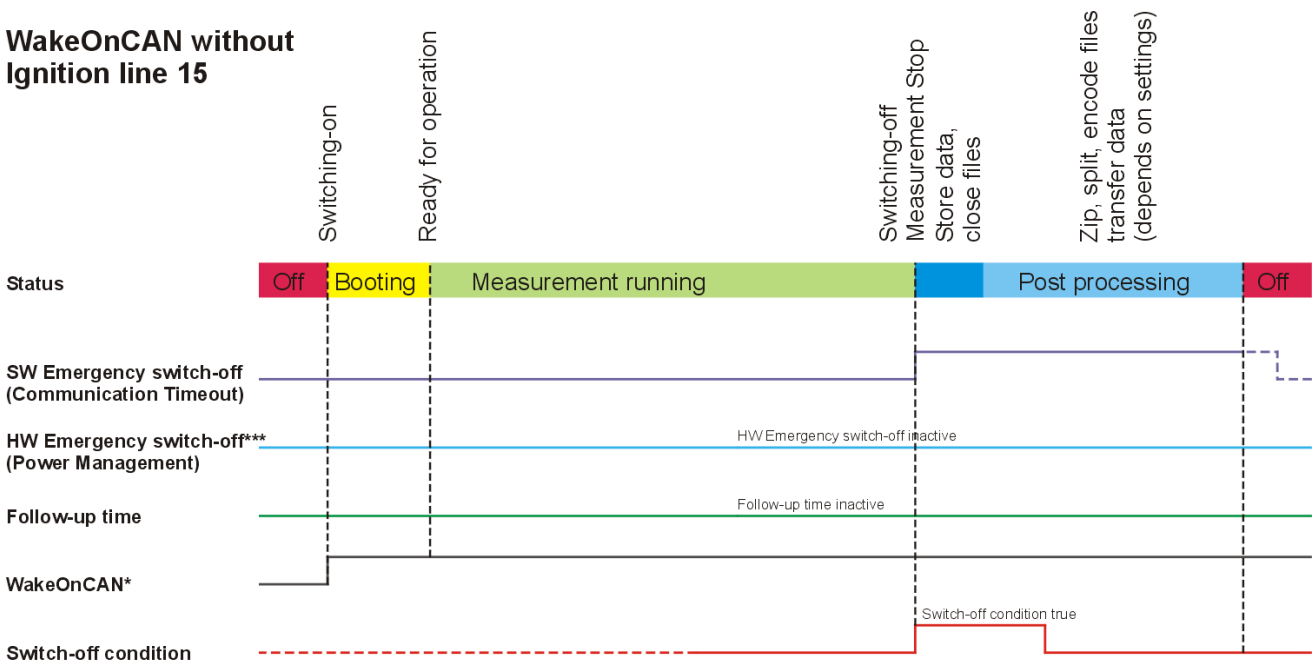

*WakeOnCAN without Ign. 15: Switch-on condition (WakeOnCAN) enabled, Switch-off condition configured, HW Emergency switch-off and Follow-up time out of operation, Timeout inactive Jumper Pin 3-6 and Pin 8-9 at respective CAN input to indicate bus traffic (WakeOnCAN)!

6.1.3 WakeOnRTC (IPElog/IPElog2 only)

With TESTdrive 3.52 and higher versions, IPElog supports switching on by its internal real time clock (RTC).

Supported events:

- ▶ Once start only one single time.
- ▶ Cyclic absolute cyclic start e.g. every hour (duration --> 1h), date/time stamp defines initial start up.
- ▶ Duration start e.g. every hour without predefined start-up.



If WakeOnCAN, WakeOnRTC or WakeOnSMS is configured with IPElog, the Ethernet status LEDs (LINK, ETH1, ETH2) will light green, even if the logger is in standby mode.

The screenshot shows the IPEmotion software interface. On the left, a tree view shows the system structure with '80900739' selected. The main area displays a table of system components:

Name	Active	Unit	Phys Min	Phys Max	Sensor Min	Sensor Max	Sampling rate
DIN 01	<input type="checkbox"/>		0	1	0	1	1 Hz
DIN 02	<input type="checkbox"/>		0	1	0	1	1 Hz
DIN 03	<input type="checkbox"/>		0	1	0	1	1 Hz
DIN 04	<input type="checkbox"/>		0	1	0	1	1 Hz
DOU T 01	<input type="checkbox"/>		0	1	0	1	1 Hz
DOU T 02	<input type="checkbox"/>		0	1	0	1	1 Hz
DOU T 03	<input type="checkbox"/>		0	1	0	1	1 Hz
DOU T 04	<input type="checkbox"/>		0	1	0	1	1 Hz

Below the table are tabs for 'General', 'Extended', 'System activated', and 'Data manager'. The 'System activated' tab is active, showing 'Switch-on condition (WakeonCAN):' set to 'Start'. Other settings include 'Timeout: 1 min', 'New measuring file number: [checkbox]', 'Start with number: 0', 'Follow-up time: 10 s', and 'Cyclical data saving: [checkbox]'. A 'Start/Stop configuration' dialog box is open, showing a table for configuring connectors:

Connector	WakeOnCAN	NML
CAN 01	<input type="checkbox"/>	<input type="checkbox"/>
CAN 02	<input type="checkbox"/>	<input type="checkbox"/>
CAN 03	<input type="checkbox"/>	<input type="checkbox"/>
CAN 04	<input type="checkbox"/>	<input type="checkbox"/>
CAN 05	<input type="checkbox"/>	<input type="checkbox"/>
CAN 06	<input type="checkbox"/>	<input type="checkbox"/>
CAN 07	<input type="checkbox"/>	<input type="checkbox"/>
CAN 08	<input type="checkbox"/>	<input type="checkbox"/>
CAN 09	<input type="checkbox"/>	<input type="checkbox"/>
CAN 10	<input type="checkbox"/>	<input type="checkbox"/>
CAN 11	<input type="checkbox"/>	<input type="checkbox"/>
CAN 12	<input type="checkbox"/>	<input type="checkbox"/>

Below this table is the 'WakeOnRTC' configuration section:

- Active:
- Mode: Duration (dropdown menu)
- Date/Time: 02.06.2014 (calendar) 20:42:48 (time)
- Duration: 1.00:00:00 (text input)
- Measure:

Buttons 'OK' and 'Cancel' are at the bottom right. A red arrow points from the 'Mode' dropdown in the dialog to the 'Duration' mode selected in the list below.

Once
Cyclic
Duration

1. Highlight the logger serial number at the left system structure.
2. Select **Start-Stop** from the tab **System activated**.
3. Activate **WakeOnRTC** from the Start/Stop configuration
4. Select a start function from the drop down field **Mode**
5. Define a **Start time** and/or **Duration** depending on the selected mode.
6. Enable the check box **Acquisition** to automatically start a data acquisition with the start-up procedure.

6.1.4 StopStart event (Logger processing)

The StopStart function closes the measurement file and after that immediately starts a new measurement. This function is triggered by a user-defined event and starts without switching off the logger.

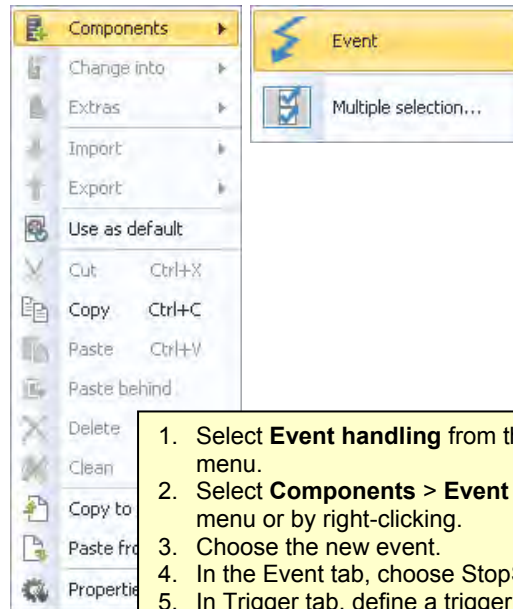
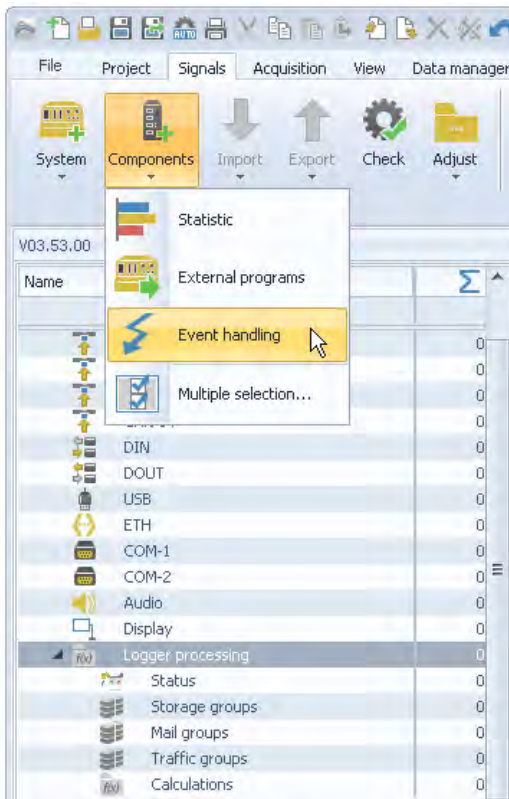

1. Select **Event handling** from the left-hand menu.
2. Select **Components > Event** from the tab menu or by right-clicking.
3. Choose the new event.
4. In the Event tab, choose **StopStart**.
5. In Trigger tab, define a triggering condition (e.g. the formula: "DIN 01" AND "DIN 02").

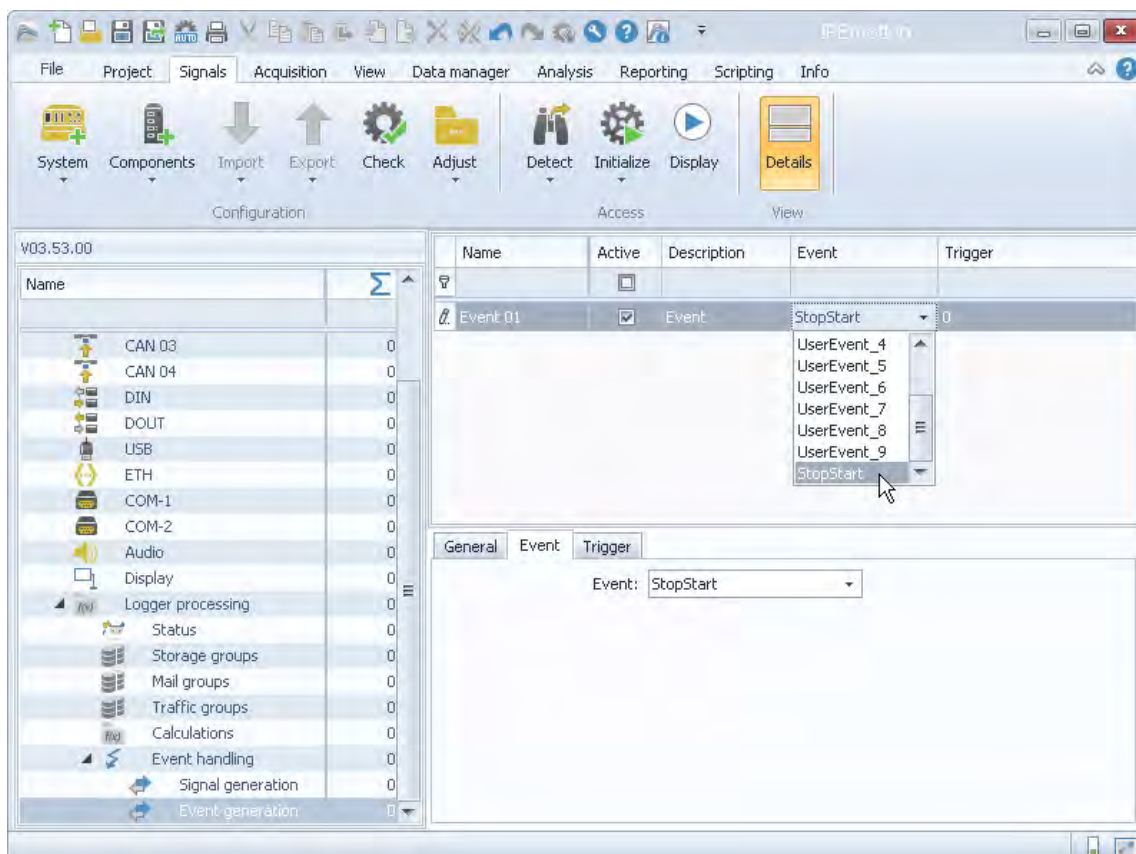

6.1.5 Use Cases

WakeOnCAN with ignition on/off

Application

Test run with continuous measurement via signal "Ignition on / ignition off" (remote); The logger is being started using bus traffic (WakeOnCAN) in order to acquire the entire starting process. After test run, CAN activity is to be acquired using the condition „Ignition off“.

Requirements

- ▶ Data logger supporting WakeOnCAN feature
- ▶ Recognition communication stop on vehicle buses:
 - > IPElog or MLOG with 4CANQS cards and FPGA as of 1.08.01, TESTdrive as of 3.52.00

Sequence

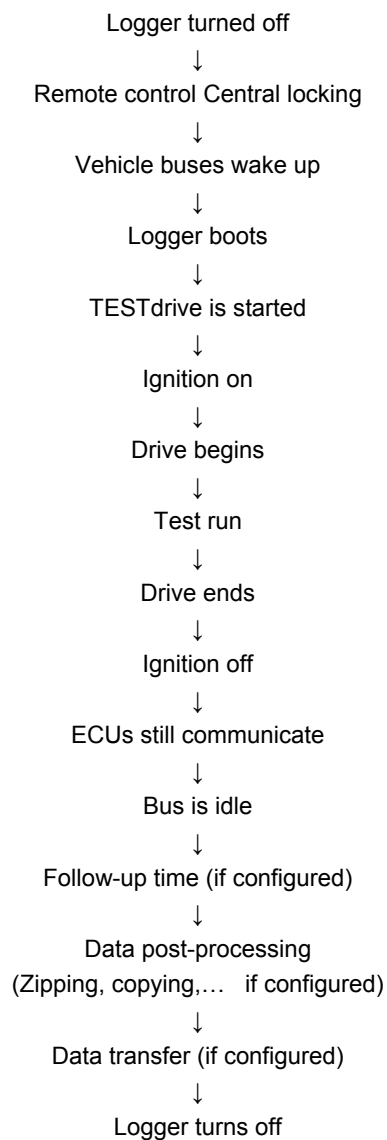

WakeOnCAN (bus activity)

Application

Monitoring of vehicle component on CAN, i.e. measurement as soon as/as long as the component is active, independent from ignition state.

Requirements

- ▶ Data logger supporting WakeOnCAN feature
- ▶ Recognition communication stop on vehicle buses:
 - > IPElog or MLOG with 4CANQS cards and FPGA as of 1.08.01, TESTdrive as of 3.52.00
- ▶ Alternatively for other logger types / firmware versions:
 - > Use of switch-off condition or WakeOnCAN timeout

Sequence

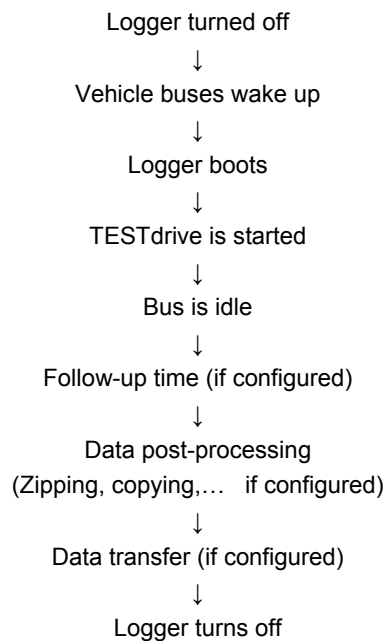

WakeOnRTC

Application

Independent from ignition state and bus traffic, the logger should start at 04:00 am every night, acquire data via connected analog modules for 2 minutes and switch back to idle state.

Requirements

- ▶ IPElog with TESTdrive as of 3.52.00

Sequence

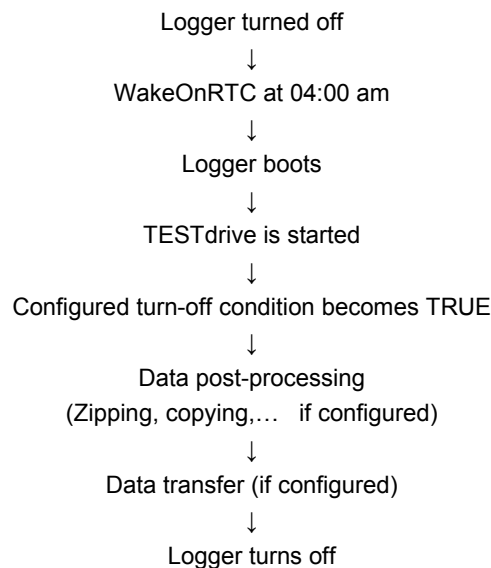

6.2 Triggering

The logger acquisition program offers 4 trigger conditions for every storage group to control the data acquisition. The trigger conditions can be deduced from acquired signals, as well as, from calculated channels. All data is written into the memory (RAM). If a storage condition is met, the data is asynchronously written from the cache into the open measuring file on the flash card.

6.2.1 Start-trigger

Start of data storage if trigger condition (impulse) is met. Stop of storage with (correct) logger shut-down (Power down). A defined follow-up time extends the data acquisition for x seconds.

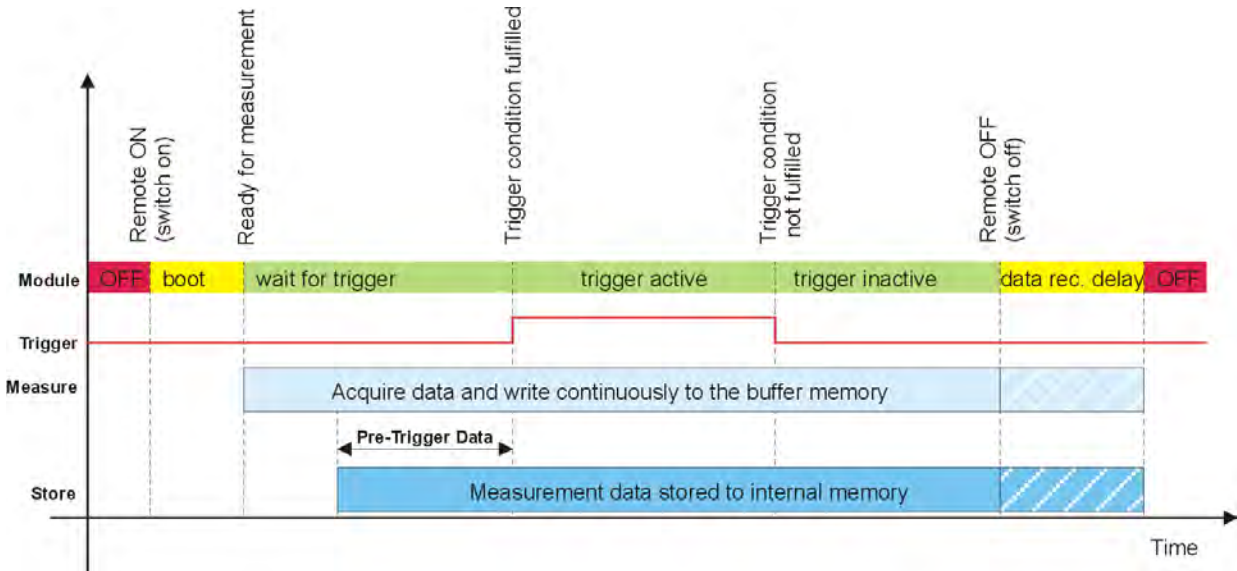

6.2.2 Stop-trigger

Begin of data storage with logger switch-on (Power up). Stop of data storage if trigger condition (impulse) is met. A defined follow-up time extends the data acquisition for x seconds. If no trigger event is set, data is recorded until "Remote OFF" or end of the follow-up time.

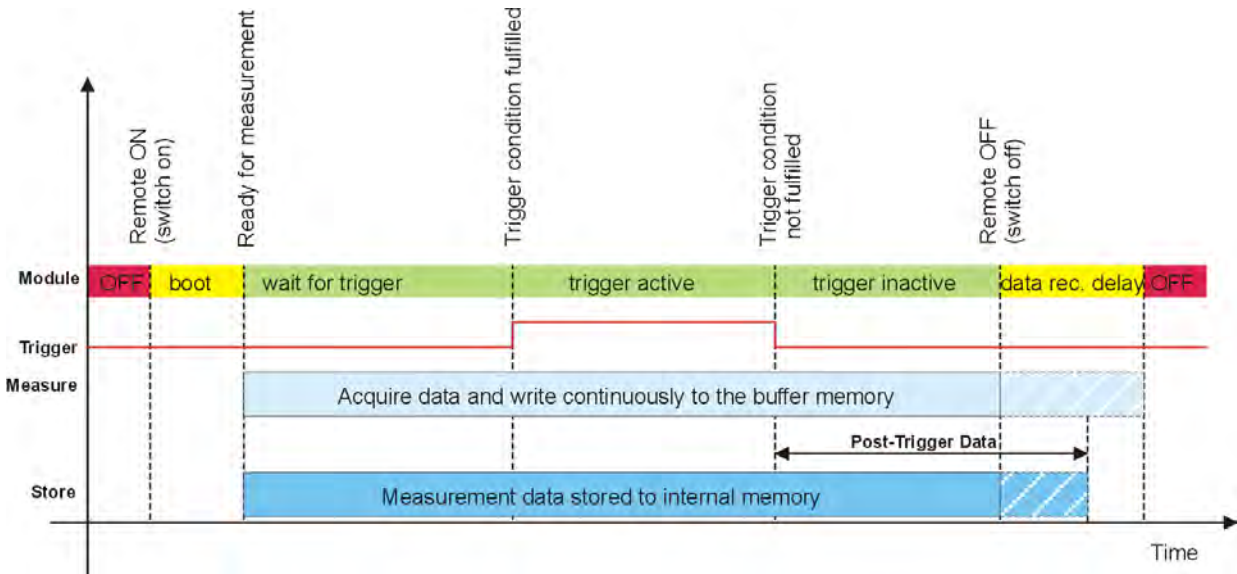

We recommend to use the function `VALID(x ; y)` in order to avoid irregular NoValues which may influence a correct triggering.

Example:

Start-trigger: `VALID(„Channel01“ > 15; 0)`

Stop-trigger: `VALID(„Channel01“ > 15; 1)`

Storage as soon as `Channel01 > 15`

Storage as long as `Channel01 > 15`

6.2.3 Start- and Stop-trigger

Begin of data storage if start-trigger condition (impulse) is met. Stop of data storage if stop-trigger condition (impulse) is met.

A defined follow-up time extends the data acquisition for x seconds. If no stop-trigger event is set, data is recorded until "Remote OFF" or end of the follow-up time.

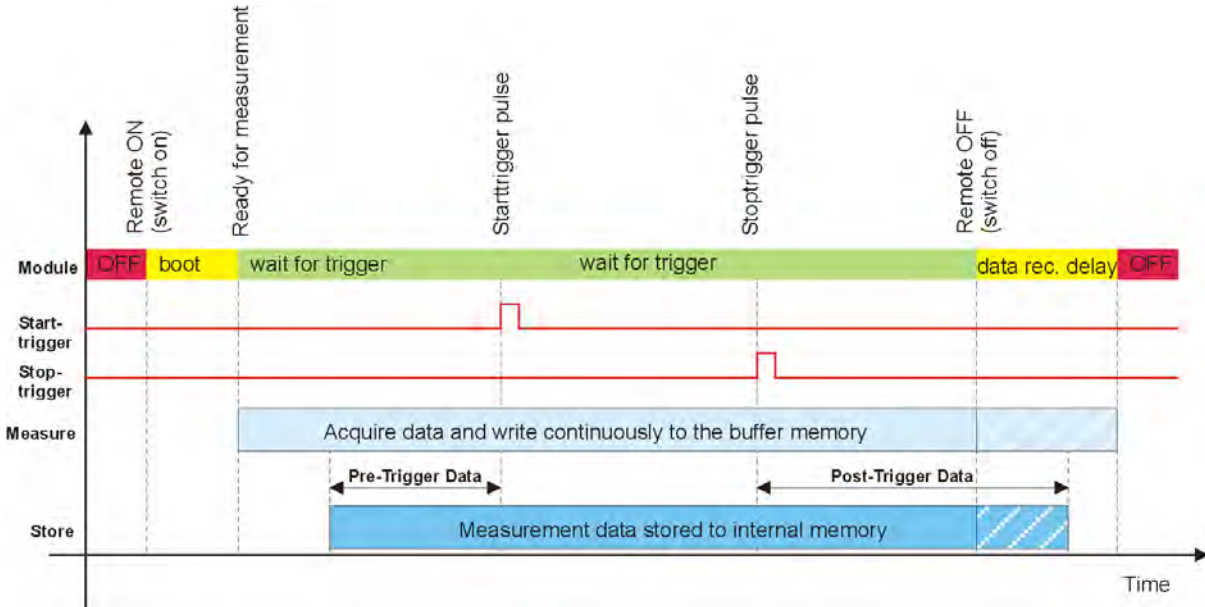

6.2.4 Stop is inverted start

Data storage for the time of meeting trigger condition (status).

A defined follow-up time extends the data acquisition for x seconds. If trigger status does not change after successful trigger condition, data is recorded until "Remote OFF" or end of the follow-up time.

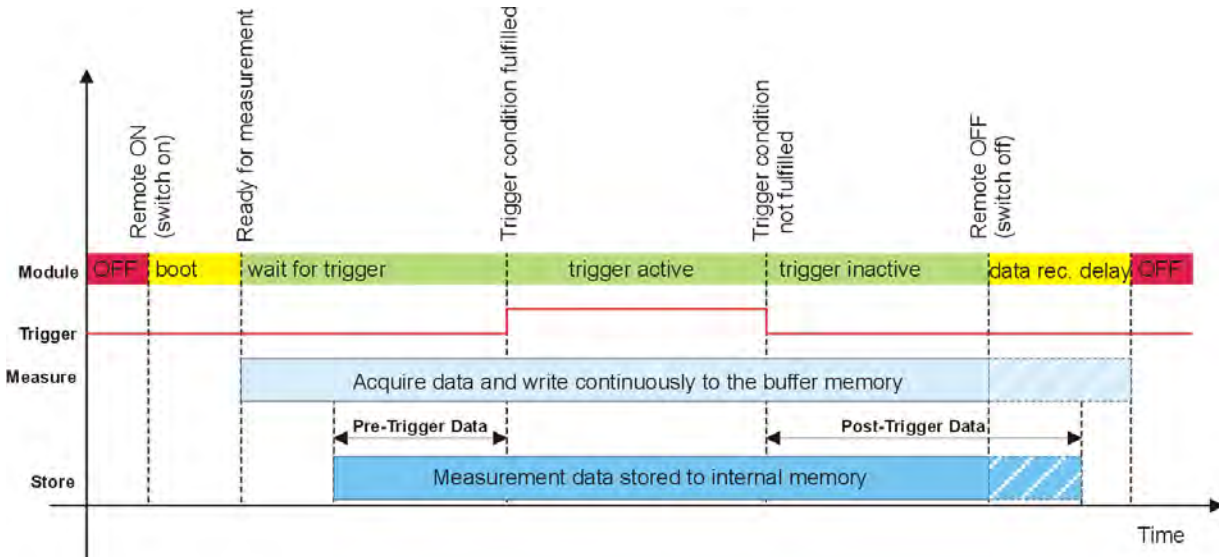

*The **Follow-up time** may not be mistaken for the **Post-processing time**. Both settings must be coordinated. The maximum post-processing time is set with **Logger > Settings > Data transfer timeout**. This setting limits the switch-on duration after successful "Remote OFF" signal. The logger is regularly shut down after this time even if the data post-processing (zipping, splitting, sending) is not yet completed. The post-processing value must be at least 5 min greater than the currently set follow-up time!*

6.2.5 Save trigger channel

If **Save trigger channel** is activated, trigger status and some additional information are stored in an implicit channel (Word data format) in every storage group.

Bit coded information in trigger status channel		
Bit No.	Description	Description (if bit value = 1)
0	Pre-Trigger	Pre-trigger time running
1	Between start and stop	Trigger signal status This bit is set during the whole acquisition in Continuous acquisition mode.
2	Post-trigger	Post-trigger time running
3	Trigger Event	This bit is set for the time of one signal at every Low > High of the trigger signal. It is set once at acquisition start in Continuous acquisition mode.
4	Maneuver	Maneuver recording running (No NoValues available anymore)
5	Res	Currently not used!
6	Res	Currently not used!
7	Res	Currently not used!
8	Res	Currently not used!
9	Res	Currently not used!
10	Res	Currently not used!
11	Res	Currently not used!
12	WakeOnCAN	WakeOnCAN ist active
13	Power Bad	The logger is disconnected from the power supply.
14	Power Good	Buffer capacitors loaded
15	KL. 15	Debounced remote signall (terminal 15)

6.3 Data groups (storage, e-mail, traffic, statistic, novalue)

TESTdrive 3,55 supports 5 different types of data groups:

- ▶ Storage groups time related data storage on the logger
- ▶ Mail groups send data snap shot at trigger event per e-mail
- ▶ Traffic groups event related (time stamp) data storage on the logger (trace data), license required
- ▶ Statistic group STG file (Statistic Group) containing min, max, mean values of the respective signals created at the end of each measurement
- ▶ NoValue group NoValue monitoring of defined signals

TESTdrive supports various data groups to merge signals (direct signals, as well as, calculated channels) for further data processing. Storage groups can have an own storage rates – independent from the signal rate. This storage rate can be valid for all signals in the group, i.e. the signal is detected with the set sampling rate and recorded with the storage rate or the individual signal sample rate is used for storage.

The maximum storage rate of a group is defined by the signal with the highest sampling rate. The frequency for online calculations corresponds to the highest sampling rate in the calculation.

Each data group has its own trigger condition (see [6.2 Triggering](#)) which can be individually defined by the user. This offers the possibility to process (storage, sending) selected signals dependent on specific events occurring, which may reduces the amount stored data and provides an easier offline data analysis.

Overview				
Data group	Settings	Trigger	Category	Remark
Storage groups	storage rates, time stamp and trigger channel, NoValues, enable external storage medium , storage group name = mea prefix	different trigger modes available, formula to define trigger condition	Yes	time related cyclic data acquisition
Traffic groups	enable external storage medium , storage group name = mea prefix	different trigger modes available, formula to define trigger condition	Yes	time stamp related bus trace acquisition
Mail groups	recipients, subject line	formula to define trigger condition	No	signal snap shot at trigger event as status information
Statistic group	none	none	Yes	min/max /average values at measurement stop
Novalue group	none	formula to define trigger condition	No	log file reporting

Categories (Data transfer category)

Data groups that create measurement data files can be assigned to data transfer categories 1, 2, 3 or they can be excluded from data transfer. Each category can be linked with a single data transfer medium, whereas all three categories can be assigned to the same data transfer medium.

Refer to **11.2.3 Data transfer & communication**

6.3.1 Storage groups

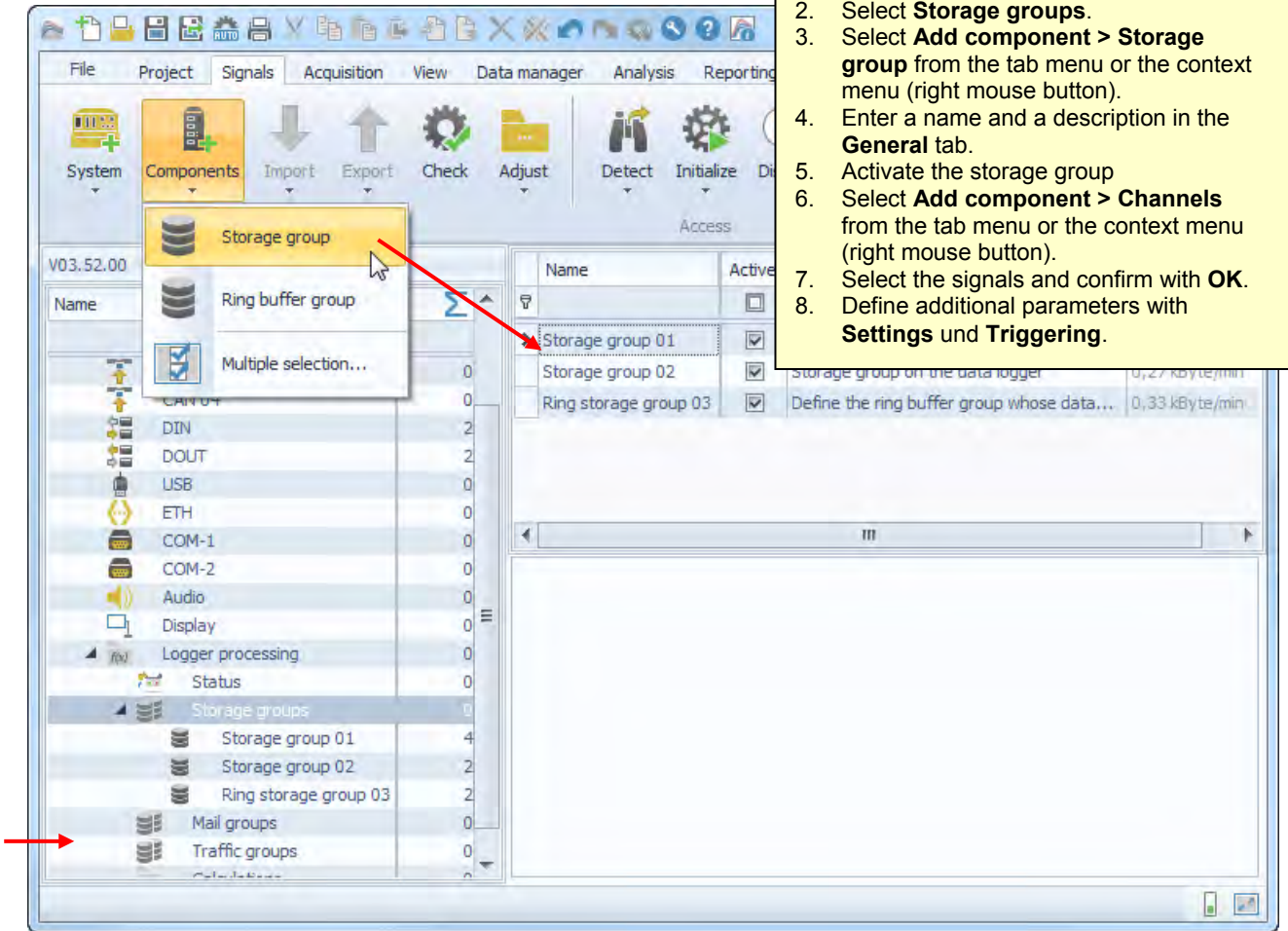

Storage group

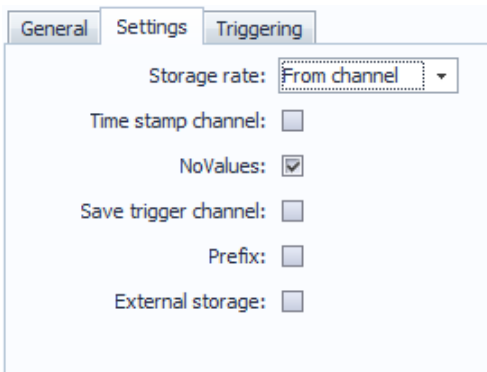

Ring buffer group

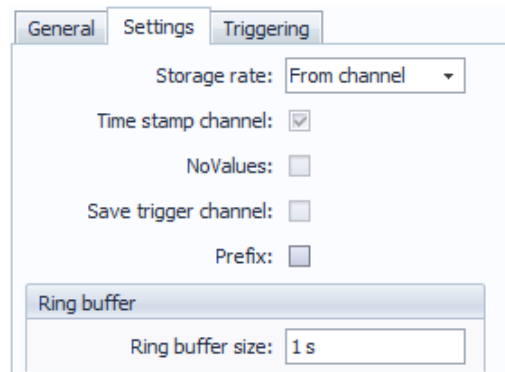

Storage rate Selection of a fixed storage rate or a channel related storage rate (From channel). Using the setting **From channel** means, the channel with the highest sample rate within the storage group will determine the storage rate.

Time stamp channel The measuring data contain the absolute time channel (logger time).

NoValue The NoValue between the trigger events, which is defined in the respective channel, is added with **Format**.

- Save trigger channel** The trigger status channel is added to the storage group and recorded. This channel contains additional information, which is saved with the single bits in the data set.
- Prefix** The storage group name is used for the measurement data file name.
- External storage** Data storage on external USB storage medium. Refer to [6.5 USB medium for external storage](#) for detailed information.
- Ring buffer size** Defines the size of the ring buffer for measuring. If the max ring buffer size is reached, the memory is overwritten beginning with the oldest data.



Use the ring buffer group to record data that are only needed in case an unknown event happens, e.g. in the event of a fault. The ring buffer group contains all selected signals of a defined period before end of measurement.

Choosing ring buffer size, consider the number of channels and defined data rates

6.3.2 Mail groups

1. Select **Signals** navigation tab.
2. Select **Mail groups**.
3. Select **Add component > Mail group** from the tab menu or the context menu (right mouse button).
4. Enter a name and a description in the **General** tab.
5. Activate the mail group
6. Select **Add component > Channels** from the tab menu or the context menu (right mouse button).
7. Select the signals and confirm with **OK**.
8. Define one or more recipients using **Settings** and define the start condition under **Trigger**.

Channel	Index	Active	Unit	Sampling rate
57801407_3	1	<input checked="" type="checkbox"/>	°C	2 Hz
57801407_4	2	<input checked="" type="checkbox"/>	°C	2 Hz
CPU load	3	<input checked="" type="checkbox"/>	%	1 Hz
57801407_1	4	<input checked="" type="checkbox"/>	°C	2 Hz
58601209_1	5	<input checked="" type="checkbox"/>	Hz	500 Hz
58601209_2	6	<input checked="" type="checkbox"/>	Hz	500 Hz

General Settings Trigger

Active:

Name: Mail group 02

Description: Mail group on the data logger

Reference: Mail group 02/80002367

General Settings Trigger

Subject: Exceeding temperature limit!

General Settings Trigger

Formula: "57801407_3" > 90

f(x)



Enter the logger settings **Data manager > Configuration > E-mail** to set the e-mail recipient and the mail server.



Creating mail groups is independent from a status e-mail. The e-mail from the mail group configuration is send, as soon as the trigger event occurs. In case of activated e-mail delivery using the data transfer configuration, a status e-mail is send at the end of each measurement.

6.3.3 Statistic group

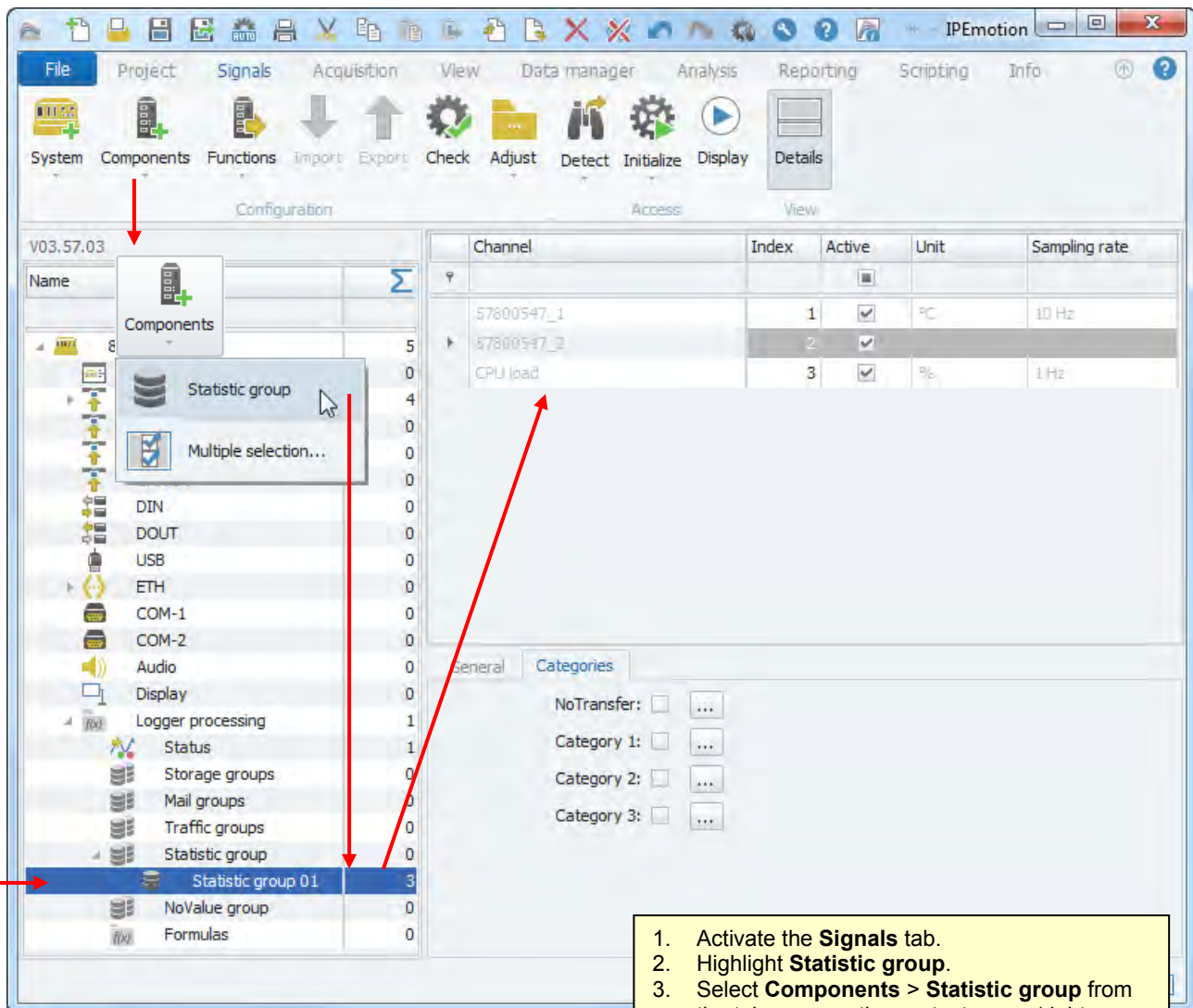

Statistic groups contain min, max and mean values of the respective signals stored in the STG file, which is created at the end of each measurement.

Please also refer to

12.5.1 Data types > Min-Max list (STG file)

1. Activate the **Signals** tab.
2. Highlight **Statistic group**.
3. Select **Components > Statistic group** from the tab menu or the context menu (right mouse button).
4. Enter a name and a description in the **General** tab.
5. Activate the **Statistic group**.
6. Select **Add component > Channels** from the tab menu or the context menu (right mouse button).
7. Select the signals and confirm with **OK**.
8. Define a data transfer categorie to be used under **Categories**.

You can now add your statistic information easily into a new created statistic group. You can create several statistic groups which can be transferred through different means.

Using the “Components” button, you can open the channel selection window to select the channel you would like to include in the Min-Max statistic calculation.

6.3.4 NoValue group

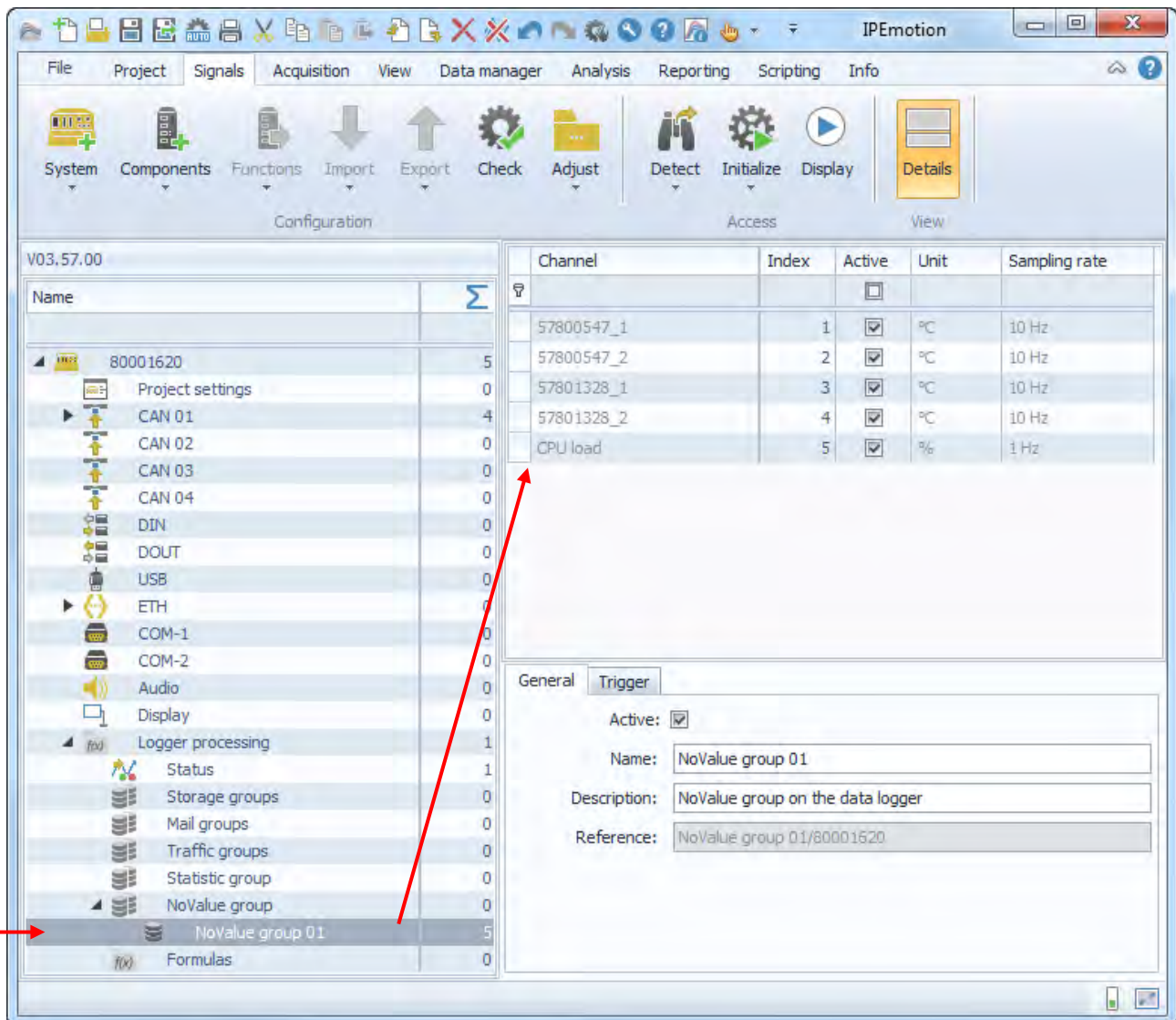

A NoValue group serves for monitoring invalid values occurring during data acquisition. Each NoValue event (means that a sequence of valid signal values is interrupted by one or more invalid values) creates a log file entry. You can use specific triggers to activate the NoValue group (for example: "CPU load" > 30 %).

Refer to **7.1.3 NoValue and timeout settings**

6.3.5 Traffic groups

Time stamp related storage of CAN bus and/or LIN bus messages.

Refer to **8.2.3 Traffic acquisition**

For explanations on cyclic and event-controlled data acquisition refer to **7.8 Event controlled measurement**

6.3.6 Trigger settings

General Settings **Triggering**

Mode: Start- and Stop-trigger

Pre-trigger duration: 10 s

Post-trigger duration: 10 s

Start-trigger: "DIN 01" f(x)

Stop-trigger: "DIN 02" f(x)

- Mode** Select the trigger mode from Continuous acquisition (no trigger), Start-trigger, Stop-trigger, Start- and Stop-trigger, Stop as inverted start (see [Triggering](#))
- Pre-trigger duration** Data recorded before the trigger event
- Post-trigger duration** Data recorded after the trigger event
- Start-trigger** Value, which starts the data storage of the respective group.
- Stop-trigger** Value, which stops the data storage of the respective group.
- Scaling** Triggering the physical value or the raw value of the numerical value calculated with the formula.



Define the triggering conditions as formula from the system signals and calculated signals. You can optimize your data recording with a clever configuration of storage groups and triggering conditions to record signals at a high storage rate only if required. This method reduces the data volume, saves memory, and facilitates the final analysis!

6.4 Status channels

6.4.1 Logger, Logger processing

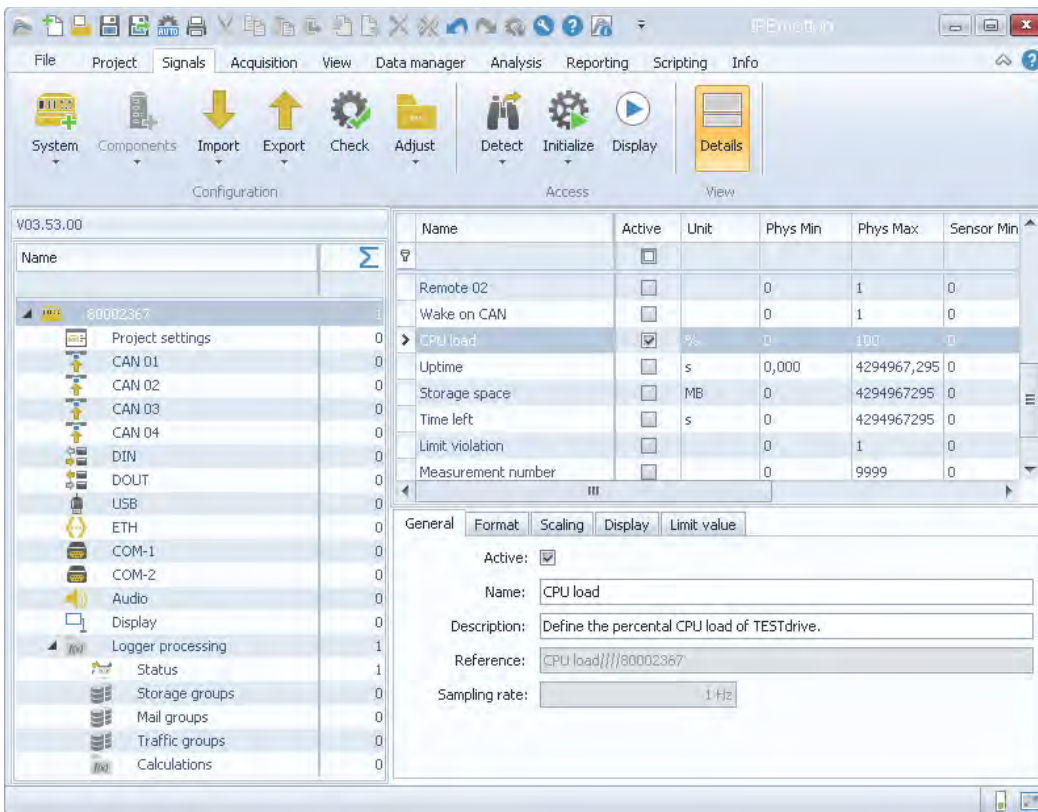

6.4.2 Video recording

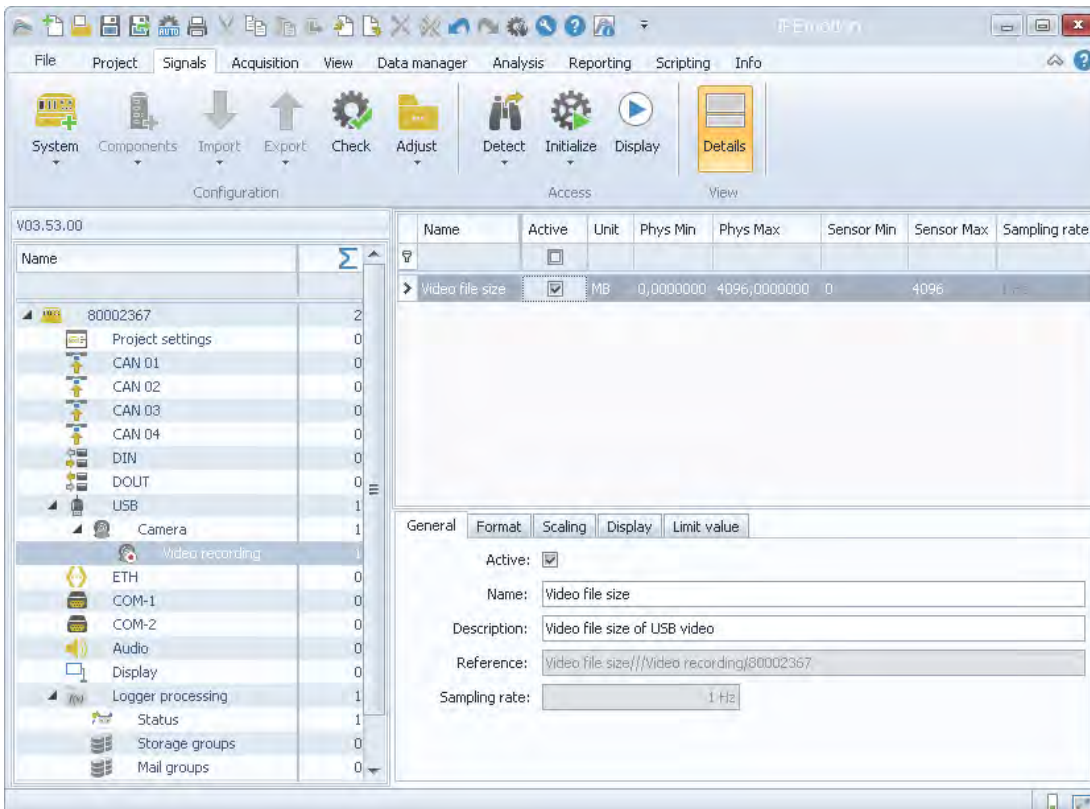

6.5 USB medium for external storage

TESTdrive supports USB sticks and USB hard disks for storage on external drives in two different modes:

- ▶ External USB medium as alternative storage (solely saving on internal drive OR external drive).
- ▶ External USB medium as supplemental storage (depending on data type settings saving on internal drive OR external drive).

6.5.1 External medium is the data drive of the logger

The USB medium is the data drive of the logger. Data is stored on this storage type exclusively. TESTdrive creates the standard folder structure on the USB drive. Depending on the current settings, data post processing and shutdown will be executed in different ways.



Because of data loss, do not disconnect the USB medium during measurement!

Behaviour with FullPostprocessing

Since TESTdrive V03.23.00 this is the default setting when using an USB data drive.

Requirement

The non-bootable USB device has to be insert before starting the logger (refer to **6.5.2 External USB medium as supplemental data drive** for preparing the device). There should be no TESTdriveCmd.xml available on the USB medium.

Utilization

During boot-up, the logger identifies the USB medium and reports "USB drive is data drive". Measurement data is stored to the subdirectory named with the logger's serial number on this storage medium. The FullPostprocessing procedure starts with the RemoteOff condition.

Behaviour without FullPostprocessing

This is the former procedure used for USB data storage until TESTdrive V03.22.01.

Requirement

The non-bootable USB device has to be insert before starting the logger (refer to **6.5.2 External USB medium as supplemental data drive** for preparing the device). There should be no TESTdriveCmd.xml available on the USB medium. With TESTdrive version V03.23.00 and subsequent releases the following command line has to be added to the dev_ctrl.xml in order to activate the usage:

```
<fastUsbDatatDriveChange>1</fastUsbDatatDriveChange>
```

Utilization

During boot-up, the logger identifies the USB medium and reports "USB drive is data drive". Measurement data is stored to the subdirectory named with the logger's serial number on this storage medium. The RemoteOff condition starts the following jobs:

- ▶ Checkdisk
- ▶ Preparing the directory structure on the USB medium
- ▶ Deleting temporary files and directories
- ▶ Power down



Independent from any data transfer settings, measurement and configuration data will not be transferred for data drives without postprocessing.

6.5.2 External USB medium as supplemental data drive

The USB storage medium is used in addition to the internal data drive of the logger. Depending on the current settings, data is stored either to the internal drive or to the external medium. TESTdrive will create the directory structure in any case.

The following data types are supported on the external USB medium:

- ▶ as of **TESTdrive V03.52** storage and traffic groups
- ▶ as of **TESTdrive V03.58** storage, traffic groups and USB video records

Requirement



The non-bootable USB storage medium has to be formatted correctly!

The Windows console software **diskpart** can be used to prepare a non-bootable USB drive for external storage.



Please take care that you select the correct drive of your PC when using diskpart!

Formatting an incorrect (internal) PC drive may cause serious problems or damage the computer!

DiskPart commands and meaning

- DISKPART> list disk** → Listing available drives
- DISKPART> select disk 8** → Selecting the respectiv drive (here disk 8)
- DISKPART> clean** → Cleaning the selected drive
- DISKPART> create partition primary** → Creating primary partition using the full drive size
- DISKPART> format fs=exfat** → Fast formatting with the exFAT format and USB stick name
 label=ExtStorage quick ExtStorage (label is an optional parameter)
- DISKPART> exit** → Closing DiskPart

Sample screenshot showing list commands

```
Microsoft Windows [Version 6.1.7601]
Copyright (c) 2009 Microsoft Corporation. Alle Rechte vorbehalten.

F:\>diskpart

Microsoft DiskPart-Version 6.1.7601
Copyright (C) 1999-2008 Microsoft Corporation.
Auf Computer: IT02-0277

DISKPART> list disk

  Datenträger ###  Status              Größe           Frei            Dyn            GPT
-----
  Datenträger 0    Online              465 GB          0 B             *
  Datenträger 1    Online              698 GB          0 B
  Datenträger 2    Online              167 GB          0 B
  Datenträger 3    Online              465 GB          0 B
  Datenträger 4    Kein Medium         0 B             0 B
  Datenträger 5    Kein Medium         0 B             0 B
  Datenträger 6    Kein Medium         0 B             0 B
  Datenträger 7    Kein Medium         0 B             0 B
  Datenträger 8    Online              7640 MB         0 B
```



```

DISKPART> select disk 8
Datenträger 8 ist jetzt der gewählte Datenträger.
DISKPART> list partition

```

Partition ###	Typ	Größe	Offset
Partition 1	Primär	7636 MB	4032 KB

```

DISKPART> clean
Der Datenträger wurde bereinigt.
DISKPART> list partition
Auf diesem Datenträger sind keine Partitionen, die angezeigt werden können,
anden.
DISKPART> create partition primary
Die angegebene Partition wurde erfolgreich erstellt.
DISKPART> list partition

```

Partition ###	Typ	Größe	Offset
* Partition 1	Primär	7639 MB	1024 KB

```

DISKPART> format fs=exfat label=ExtStorage quick
100 Prozent bearbeitet
DiskPart hat das Volume erfolgreich formatiert.
DISKPART> exit
Datenträgerpartitionierung wird beendet...
F:\>_

```



Upon completion of this preparation, the USB medium is ready for use with IPElog and M-LOG V3, but not with M-LOG, as the BIOS of the logger types are different!

For usage with M-LOG, the MBR (Master Boot Record) of the USB medium has to be deleted.



Once the MBR of the medium has been deleted, it can be no longer used with IPElog or M-LOG V3!

We recommend to prepare separate USB storage devices for the respective logger types.

Deleting the bootloader requires a determination of logical and physical drive!

The tool **Hex Workshop** can be used for deleting the bootloader, as it supports access to the physical part of the drive.

The tool is available for download from:

<http://www.hexworkshop.com/>

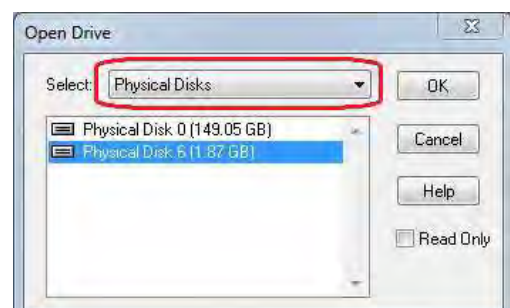

The MBR (Master Boot Record) is the physical drive area. The bytes assigned to address range 0x000 to 0x01B7 (Bootloader) have to be deleted, this means set to 0.

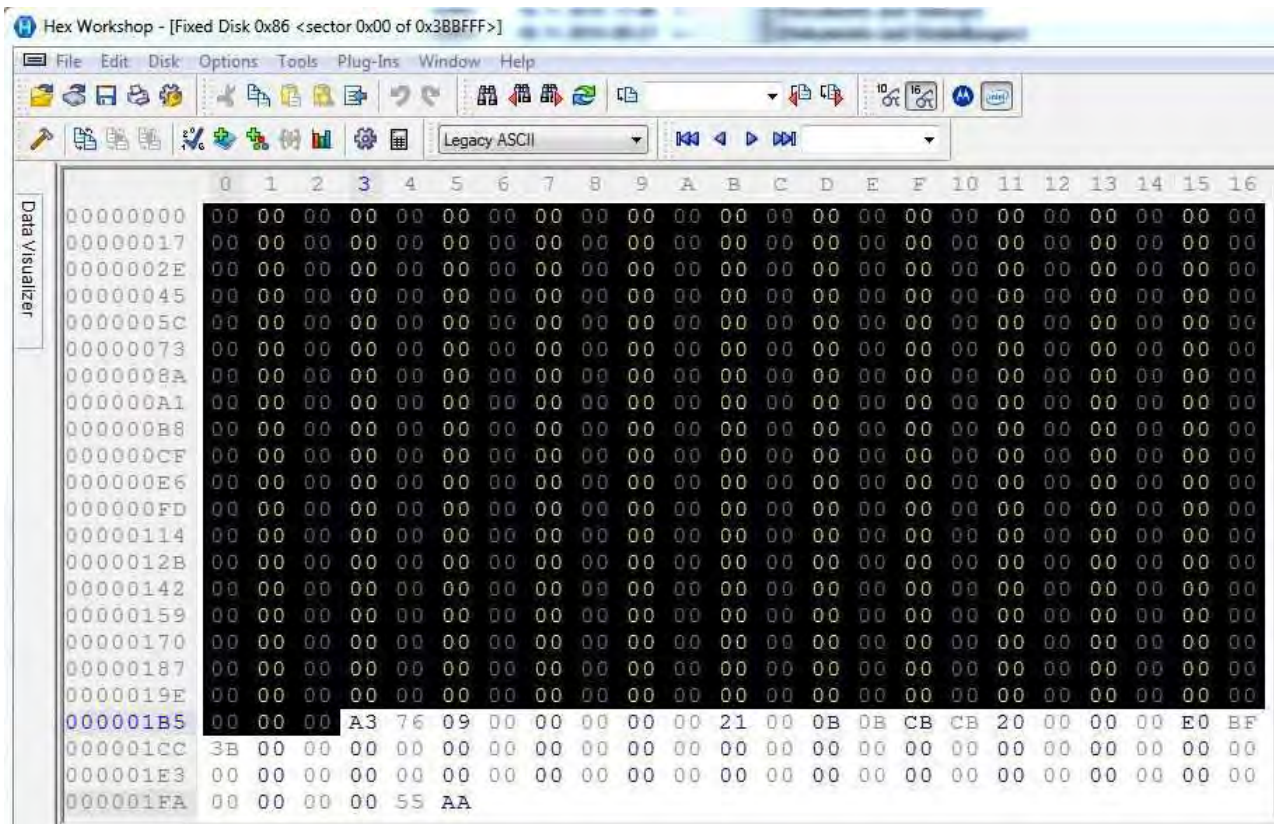

The TESTdriveCmd.xml with the contents listed below has to be copied to the USB medium:

```
<TESTdriveCmd>
  <Authentication>
    <user>guest</user>
    <password>ipe_guest</password>
  </Authentication>
  <OnConnect>
    <JobList>
      <Job>
        <Name>startExternalStorage</Name>
      </Job>
    </JobList>
  </OnConnect>
  <OnDisconnect>
    <JobList>
      </JobList>
    </OnDisconnect>
  </TESTdriveCmd>
```



Using a TESTdriveCmd.xml with other commands will execute these jobs and waiting for disconnecting the USB medium.
The storage to the external drive will not be started in this case.

In addition to an appropriate TESTdriveCmd.xml, the correct settings for storage and/or traffic groups or USB video recording are required → Activate **External storage**.

General Settings Triggering Categories

Storage rate: From channel

Time stamp channel:

NoValues:

Save trigger channel:

Prefix:

Prefix preview: DO

External storage:

With USB video recordings, the total memory space available on the USB device can be limited by PlugIn specific settings.

(Options → PlugIns → IPETRONIK LOG PlugIn-specific settings → Extended → Open system setup).

IP Extended options

Video input

Maximum memory space: 1000 MB

Maximum memory space (external): 1000 MB

Maximum file length: 1000 MB

Application

Storage on external USB device is supported for triggered measurements as well as continuous measurements (TESTdrive V03.54.00 or a newer release required).

The USB medium can be connected to the logger before boot up or when the measurement has been already started (TESTdrive ≥ V03.54.00). TESTdrive writes data directly to the external USB drive.

If the start trigger for data storage is active but no USB device available, the logger will report the respective warning:

"No USB-Stick with TESTdriveCmd. Storage group [Name] cannot be stored externally."

"No USB-Stick with TESTdriveCmd. Traffic group [Name] cannot be stored externally."

"Video([Nummer]): No USB-Stick with TESTdriveCmd. Video files cannot be stored externally."

The external storage has to be stopped before unplugging the USB medium. We recommend to end the complete measurement (not only USB storage) as the operating system could respond unforeseeable on unplugging the USB medium. If this procedure is not possible, a stop trigger has to be configured to end the data storage regularly.



Unplugging the USB medium while external storage groups are active causes data loss!

Configure stop trigger conditions or end the measurement (power down) to unplug the USB medium from the logger without data loss.

7 Standard functions

7.1 Calculations

TESTdrive supports the online calculation of the signals acquired in the system. The desired calculation is defined with the corresponding software dialog – manually or with the formula editor.

IPEmotion Version 1.03 and PlugIn IPETRONIK-LOG \geq V03.20 offer a shared formula editor, i.e. the following calculation functions are available in IPEmotion, as well as, in TESTdrive.



Calculations, which are based on each other, must be run in the same cycle rate to get a correct result! If, e.g., the result of a calculation with low cycle rate is used in a calculation with higher cycle rate, a time offset results, which can influence the result according to a signal change (amplitude). In that case, the signal sampling rate of the first calculation must be raised.

The formula editor requires the use of the semicolon “;” instead of the comma “,” as variable separator.

If a value within a calculation is “NoValue“, the calculation result is “Novalue“, too.

7.1.1 Mathematic functions and operations

1 Basic operation				
Operator	Name	Syntax	Example	Result
+	Addition	“Temp01“ + “Temp02“	15 + 10	25
-	Subtraction	“Temp01“ - “Temp02“	15 - 10	5
*	Multiplication	“Temp01“ * “Temp02“	15 * 10	150
/	Division	“Temp01“ / “Temp02“	15 / 10	1.5
MOD	Modulo, Division rest	“Temp01“ MOD “Temp02“	15 MOD 10	5
ABS()	Absolute value of a number	ABS(“Temp01“)	ABS(-15)	15
SIGN()	Sign of a number	SIGN(“Temp01“)	SIGN(15) SIGN(0) SIGN(-15)	1 0 -1
NEG()	Negation of a number	NEG(“Temp01“)	NEG(15) NEG(-15)	-15 15
(Begin bracket term	(“Temp01“ + “Temp02“) * 2	(15 + 10) * 2	50
)	End bracket term	(“Temp01“ - “Temp02“) * 2	(15 - 10) * 2	10

2 Power, Square root, Exponential and Logarithm functions				
Function	Name	Syntax	Example	Result
^	Power	“Temp01“ ^ 2	15 ^ 2	225
SQRT()	Square root	SQRT(“Temp01“)	SQRT(25)	5
EXP()	Exponential function of basis e	EXP(“Temp01“)	EXP(5)	148.41
LOG()	Logarithm of basis 10	LOG(“Temp01“)	LOG(5)	0,4771
LN()	Logarithm of basis e	LN(“Temp01“)	LN(5)	1.0986

3 Trigonometric functions, Hyperbola functions		
Function	Name	Range of values in radian
SIN()	Sine	+/-3.99 rad
COS()	Cosine	+/-3.99 rad
TAN()	Tangent	+/-3.99 rad
ASIN()	Arc sine	+/-1.0 rad
ACOS()	Arc cosine	+/-1.0 rad
ATAN()	Arc tangent	+/-1.0 rad
SINH()	Sine Hyperbolicus	+/-1.99 rad
COSH()	Cosine Hyperbolicus	+/-1.99 rad
TANH()	Tangent Hyperbolicus	+/-1.99 rad

4 Comparative operations (comparison of variable values)				
Function	Name	Syntax	Example	Result
=	Equal	"Temp01" = "Temp02"	15 = 10 15 = 15	0 1
<>	Unequal	"Temp01" <> "Temp02"	15 <> 10 15 <> 15	1 0
<	Less than	"Temp01" < "Temp02"	10 < 15 15 < 15	1 0
>	Greater than	"Temp01" > "Temp02"	15 > 10 15 > 16	1 0
<=	Less than or equal	"Temp01" <= "Temp02"	10 <= 15 15 <= 15 20 <= 15	1 1 0
>=	Greater than or equal	"Temp01" >= "Temp02"	15 >= 10 15 >= 15 15 >= 20	1 1 0
IF(; ;)	If function	IF("Temp01" >= "Temp02"; x; y) Query to a specific status. If Occurrence > action 1, otherwise action 2 Example: IF("Thermo_channel3" > 30; 1; 0) If Temperature > 30, Result: 1 otherwise 0 Action 1 and 2 can also be calculations.	x = 1; y = 0 "Temp01" = 15 "Temp02" = 10 "Temp01" = 10 "Temp02" = 15	1 0

5 Logic operations (comparison of signal states)				
Function	Name	Syntax	Example	Result
AND	And	"Temp01" > "Temp02" AND "Temp01" > 10	15 > 5 15 > 10 10 > 5	1 1 0
OR	Or	"Temp01" > "Temp02" OR "Temp01" > 10	15 > 5 10 > 5 10 > 10	1 1 0
XOR	Exclusiv or	"Temp01" > "Temp02" XOR "Temp01" > 10	15 > 5 10 > 5 15 > 15 10 > 10	0 1 1 0
NOT()	Not	NOT("Temp01" > "Temp02") (inverse state)	15 > 5 15 > 15 5 > 15	0 1 1

6 Boolean operations (bitwise comparison of signal states)				
Function	Name	Description	Example	Result
ANDB	And bitwise	Bits which are set in operand1 and in operand2 will be set in the result (bit = 1), all others will be not set (bit = 0)	27 ANB 12 11011 ANDB 01100	8 01000
ORB	Or bitwise	Bits which are set in operand1 or in operand2 will be set in the result (bit = 1), all others will be not set (bit = 0)	26 ORB 8 11010 ORB 01000 27 ORB 13 11011 ORB 01101	26 11010 31 11111
XORB	Exclusive or bitwise	Bits which are set only in operand1 or only in operand2 will be set in the result (bit = 1), all others will be not set (bit = 0)	26 XORB 8 11010 XORB 01000 27 XORB 13 11011 XORB 01101	18 10010 22 10110
NOTB	Not bitwise	Bits which are set in operand1 will be not set in the result (bit = 0), all others will be set (bit = 1)	NOTB 27 NOTB 11011	4 00100

7 Statistic functions				
Function	Name	Syntax , Description	Example	Result
MIN()	Minimum	MIN("Temp01")	4 12 3 25 17	3
MAX()	Maximum	MAX("Temp01")	4 12 3 25 17	25
MEAN()	Average	Average from all valid values		
MEAN(;)	Average from n values	Average from n valid values		
MINOR(;)	Less value	MINOR("Temp01"; "Temp02)	4 12	4
MAJOR(;)	Greater value	MAJOR("Temp01"; "Temp02)	4 12	12
FLOOR()	Round integer off	FLOOR("Temp01")	13,72	13
CEIL()	Round integer up	CEIL("Temp01")	13,41	14
ROUND()	Round integer	ROUND("Temp01")	13,41 13,72	13 14
LIN(; ;)	Linearization	LIN("Temp01"; x node-1;y node-1; x node-n; y node-n) Runs a linearization with the defined nodes. Between n = 2 and n = 16 nodes can be defined.		

8 Other functions	
Function	Description
EDGE_POS()	Detect positive edge 1 if current value is > 0 and the previous one <= 0
EDGE_NEG()	Detect negative edge 1 if current value is <= 0 and the previous one > 0

Function	Description	Example	Result
DIFF()	Runs a differentiation of an operand acc.to: (Opr1(t) – Op1(t-1)) * DeltaT		
INT()	Calculates the integral of an operand acc. to: "((Op1(t) + Op1(t-1))/2) * DeltaT"		
INT_ADD()	Calculates the integral of an operand acc. to: "((Op1(t) + Op1(t-1))/2) * DeltaT" and adds the result to the previous value		
INT_UP()	Calculates the upper integral of an operand acc. to: "Op1(t) * DeltaT"		
PREV()	Outputs the previous value.	PREV("Temp01") 4 12 3 25	NV 12 3
(„Temp1“ + (PREV („Temp1“)) + (PREV (PREV („Temp1“)))) / 3	Floating average from the current value and both previous values		
SHL(;)	Shift value bitwise to the left.	1 SHL 2 001 SHL 2	4 100
SHR(;)	Shift value bitwise to the right.	12 SHR 1 1100 SHR 2	6 0110
TESTBIT(;)	Checks the value (0, 1) of the defined bit. If the bit described by operand 2 is set, result = 1, otherwise result = 0 (Counting order starting right hand with 0)	TESTBIT(1101; 3) TESTBIT(1101; 1)	1 0
TESTMASKS(;)	Makes a comparison with a user definable bitmask. If at least one bit is set in operand 1 and also in operand 2, result = 1, otherwise result = 0	TESTMASKS(27, 6) TESTMASKS(27, 4)	1 0
TIME()	TIME("Temp01") A counter that adds the time intervalls of the corresponding sample rate continuously and outputs the sum as long as the operator's value is >= 0.5 In case the operator's value is < 0.5, the counter is reseted and 0 is output.		
TIMER(;)	If no new value is received from the channel defined as Parameter1 within the timeout (Parameter2 in seconds), the output value is '1'.		
VALID()	Check for validity 1 if value is unequal to NoValue, 0 if value is NoValue		
VALID(x; y)	Avoid Novalues x if value is unequal to NoValue, y if value is NoValue		
ISNOVALUE(x; y)	Delay of a NoValue identification (x: signal value, y: optional time delay) If y is not set resp. its value is 0, the result is true, as soon as x = NoValue Is y ≠ 0 the result is true, as soon as x = NoValue for a minimum duration of y seconds. Is x ≠ NoValue, the result is always false.		
RADIUS(y; z)	Radius calculation polar coordinates ($r = \sqrt{y^2 + z^2}$) = SQRT("phi_y" * "phi_y" + "phi_z" * "phi_z")		
ANGLE(y; z)	Angle calculation in polar cordinates = IF("phi_z" >= 0; ACOS("phi_y" / "Radius") * 180/PI; -1 * ACOS("phi_y" / "Radius") * 180/PI + 360)		

7.1.2 Constants

9 Constants	
Constant	Description
PI	$\pi > \pi = 3.141592654 \dots$
SYSTEMRATE	TESTdrive internally works with a fix system rate. This rate depends on the configuration (Channel with highest sampling rate) and can be used for calculations. The system rate can be compared with the timer ticks of a PC clock and is set in Hz. The system rate relates to the working frequency of the PC/Notebook (= Frequency of the High-Performance-Counter).
SYSTEMTIME	Reciprocal value of the system rate ($=1/\text{SYSTEMRATE}$) and is set in seconds. Please note at using a system rate in the MHz range that the system time can only be correctly displayed if sufficient decimals have been defined and Automatic has been selected in Display > Formatting.
SAMPLERATE	Channel sample rate in Hz
SAMPLETIME	Channel acquisition intervall in 1/s

7.1.3 NoValue and timeout settings

In order to differ invalid and valid measurement values, the user can select -FullScale, Null or +Fullscale (for analog inputs) to be identified as invalid value (NoValue). A signal value at the upper or lower limit range could be invalid, as it can not occur really. Another used case are missing messages at the CAN bus. An expired fimeout can be used to indicate invalid values.

Settings possibilities

Measurement input

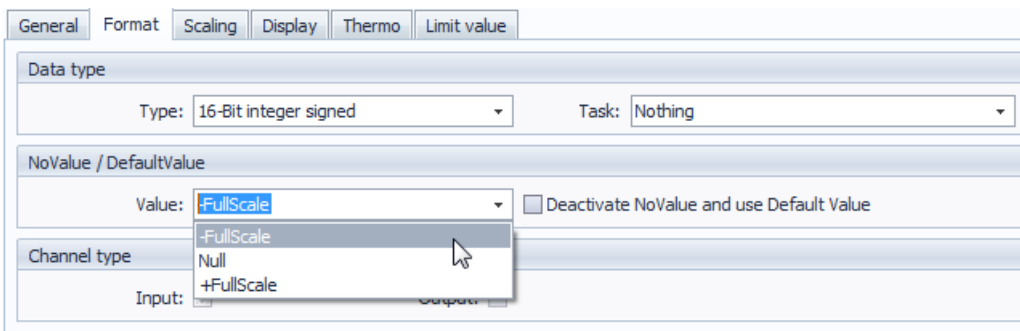

The setting for the signal input (e.g. IPETRONIK CAN measurement module) or the CAN signal input defines the invalid value (NoValue) within the measurement range (selection -FullScale, Null, +FullScale).

If this function is deactive, the measurement value is used (e.g. -60 °C with M-THERMO), NoValues are suppressed in this case.

A NoValue alarm can be activated for every signal within the **Format** tab.

IPEmotion Options

The **IPEmotion Options Expert settings** (select **Basic settings > Expert mode**) provide a **No value timeout** for the online data acquisition. If values are missing with a cyclic data acquisition, subsequent samples will be output as NoValue if the timeout range has expired. The setting range for the No value timeout is 0 ... 5 s.

This setting has no effect on the data acquisition by the logger. Please use the PlugIn Options for this.

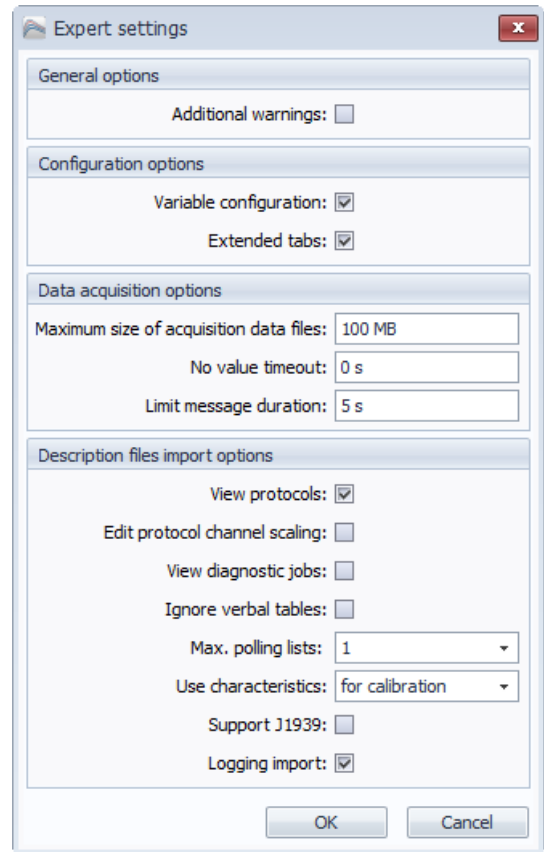

PlugIn Options

Entering the **IPEmotion Options**, the options tab of the PlugIn IPETRONIK LOG (select **current PlugIn > Options > NoValue-Alarm Timeout (s)**) provides the logger acquisition timeout. . If values are missing with a cyclic data acquisition, subsequent samples will be output as NoValue if the timeout range has expired. The setting range for the No value timeout is 0 ... 120 s.

Conditioned by different delays during initialization (modules, logger) when measurement has been started, NoValues can occur during this phase.

Use the setting **NoValue start delay (s)** in order to avoid NoValues at measurement start.

The setting range for the No value start delay is 0 ... 600 s.

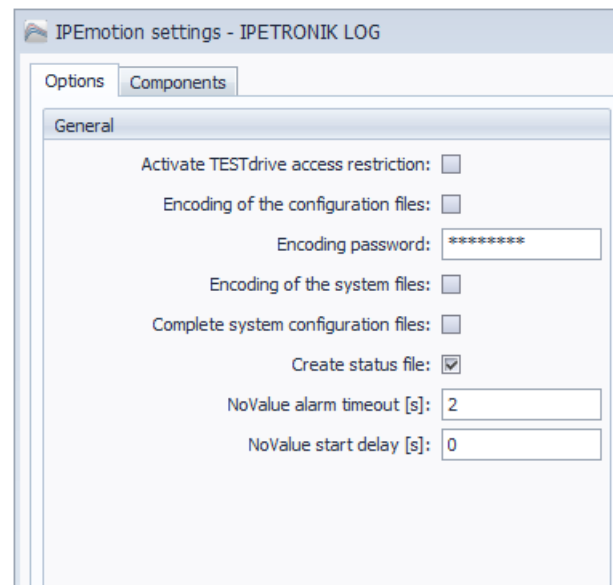

CAN input

Each CAN input of the logger provides timeout settings with an adjustable delay time (select for example **CAN 02** > tab **Extended** > **Timeout value 2 s**). If the CAN input do not receive messages anymore and the timeout period has expired, the logger starts writing NoValues to the data record.

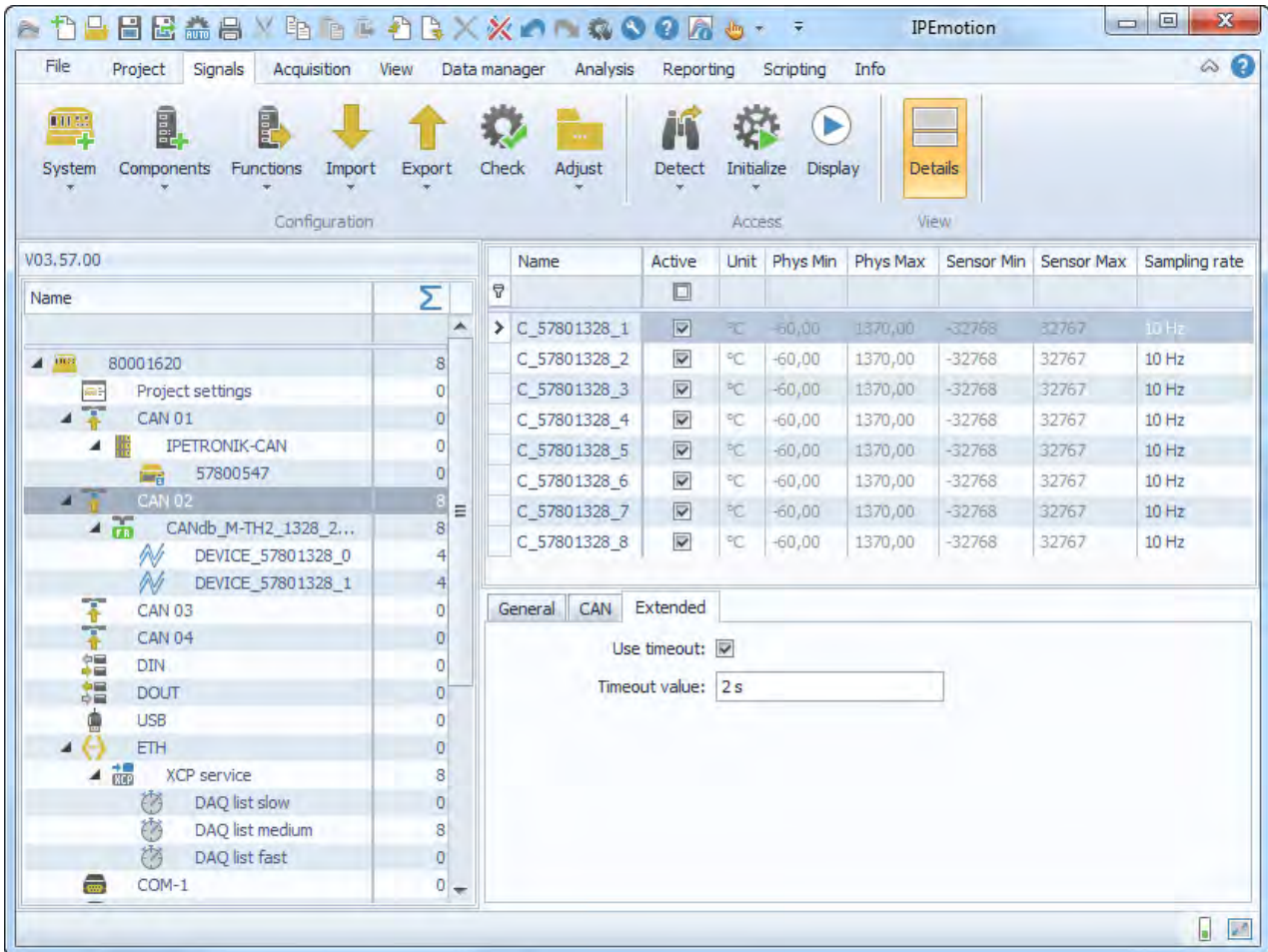

Log file entries

If the NoValue monitoring is activated and NoValues are occurring, the system will record the series of NoValues itself (instead of the signal value) and the corresponding log file entry.

Example

NoValue monitoring at CAN 01 Timeout value 20 s

Log file entry: *D CAN signal measurement timeout (no valid ID) on CAN 01 (t > 20000 ms)*

7.1.4 Calculation examples

Greater comparison „>“

Syntax >

Description Compares the current value (of a channel or a calculation) with a user defined constant or variable. The result is 1, as long as the comparison is true, otherwise the result is 0 (for a false comparison).

Example „Channel01“ > 2 *Comparison with a constant*
 „Channel01“ > „Channel02“ *Comparison with a variable*

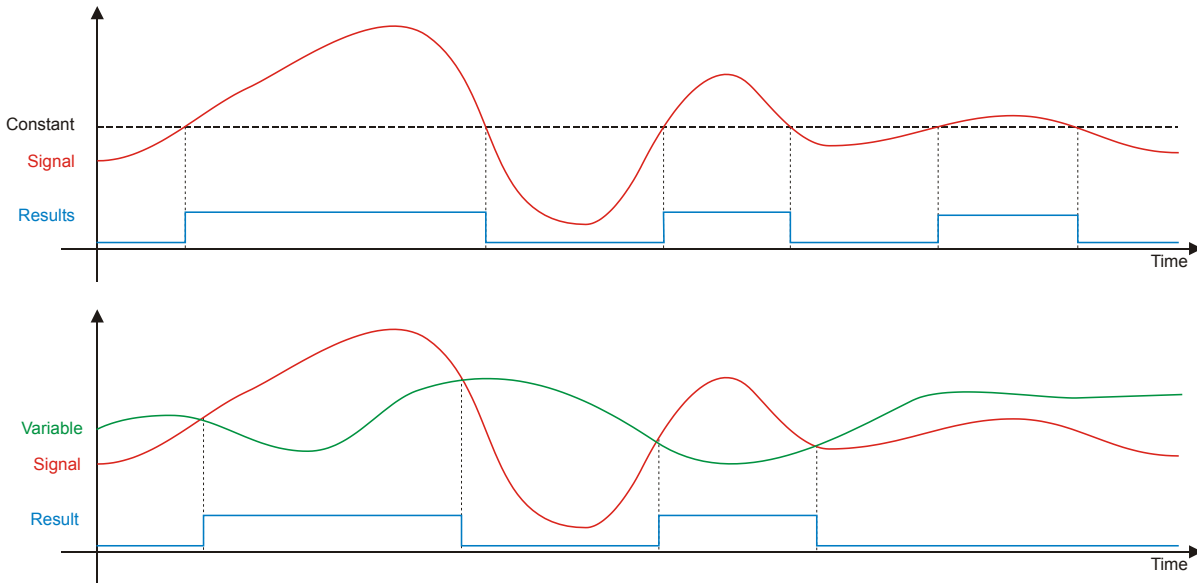

Less comparison „<“

Syntax <

Description Compares the current value (of a channel or a calculation) with a user defined constant or variable. The result is 1, as long as the comparison is true, otherwise the result is 0 (for a false comparison).

Example „Channel01“ < 2 *Comparison with a constant*
 „Channel01“ < „Channel02“ *Comparison with a variable*

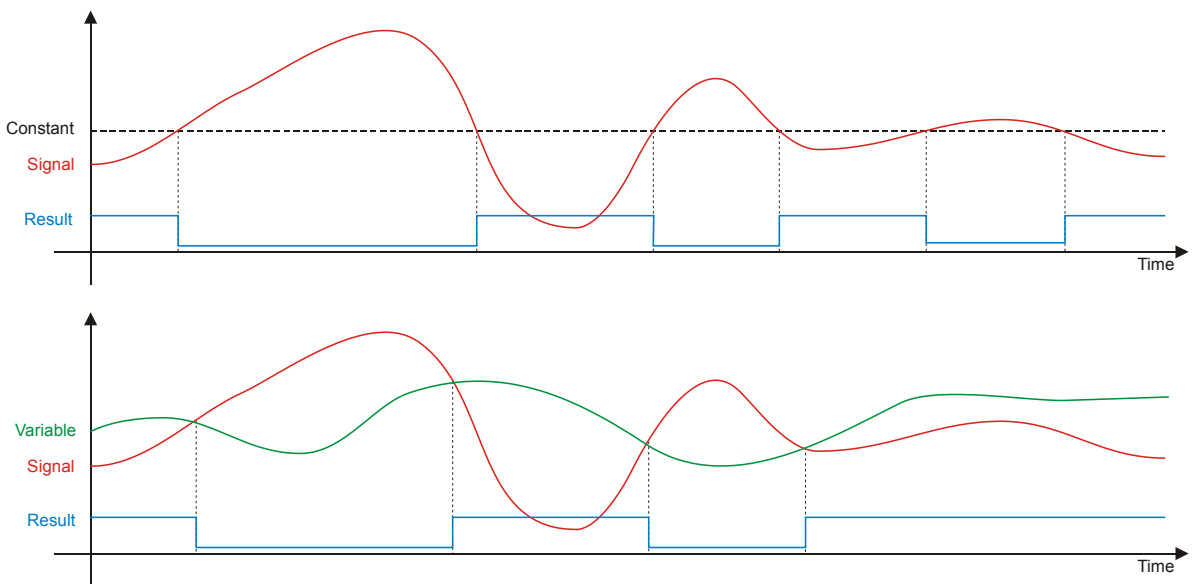

Counter (without reset)

Syntax „Counter01“ + x
VALID(“Counter01”; 0) + x

Description Counts continuously with the current sample rate, i.e. the counter value is increased by x with each sample. The rise of the counter slope depends on the currently configured sampling rate and the counter step. A measurement stop resets the counter to 0.

Example „Counter01“ = „Counter01“ + 1 *Accumulates 1 with each sample*
„Counter01“ = „Counter01“ + 10 *Accumulates 10 with each sample*

Tip Used with TESTdrive (logger application) this recursive formula will result in valid values as the initial value for variables is set automatically. Used with IPEmotion (Acquisition > Calculations > Formulas) the respective formula has to be completed with the Valid function: „Counter01“ = VALID(„Counter01“; 0) + 1
The Valid function sets the initial counter value to a defined value (here 0) in case the current value is invalid.

Counter with counting condition

Syntax IF(“Channel01” > x; „Counter01“ + y; „Counter01“)
IF(“Channel01” > x; VALID(“Counter01”; 0) + y; VALID(“Counter01”; 0))

Description Counts continuously with the current sample rate, as long as, the current value of "Channel01" is greater than x. The counter value is increased by y with each sample, as long as "Channel01" fulfills the condition. Otherwise the counter remains unchanged. As soon as the condition is fulfilled again, the counter continues with the previous value. The rise of the counter slope depends on the currently configured sampling rate and the counter step. A measurement stop resets the counter to 0.

Example „Counter01“ = IF(“Channel01” > 5; "Counter01" + 1; „Counter01“)
Accumulates 1 with each sample as long as "Channel01" is greater than 5.
Stop counting and holding the latest value, as soon as „Channel01“ is less than 5.

Tip Used with TESTdrive (logger application) this recursive formula will result in valid values as the initial value for variables is set automatically. Used with IPEmotion (Acquisition > Calculations > Formulas) the respective formula has to be completed with the Valid function.

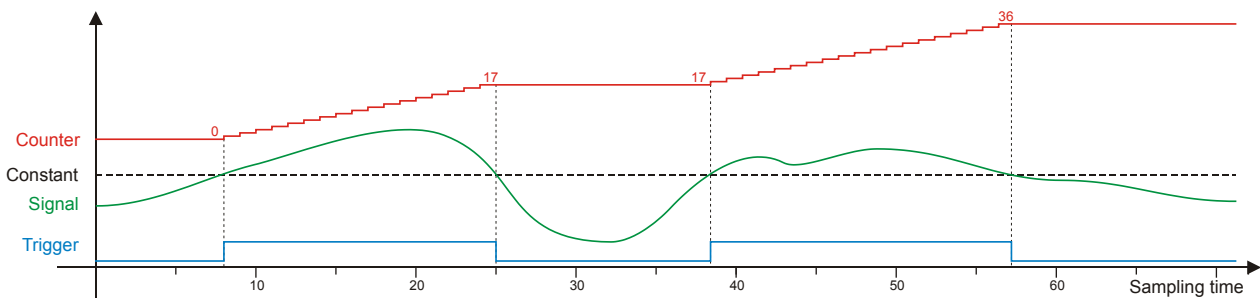

Counter with counting condition and reset

Syntax **IF("Channel01" > x; „Counter01“ + y; 0)**
IF("Channel01" > x; VALID("Counter01"; 0) + y; 0)

Description Counts continuously with the current sample rate, as long as, the current value of "Channel01" is greater than x. The counter value is increased by y with each sample, as long as "Channel01" fulfills the condition. Otherwise the counter will be reset to 0. As soon as the condition is fulfilled again, the counter restarts with 0. The rise of the counter slope depends on the currently configured sampling rate and the counter step.
 A measurement stop resets the counter to 0.

Example „Counter01“ = IF("Channel01" > 5; „Counter01“ + 1; 0)
*Accumulates 1 with each sample as long as "Channel01" is greater than 5.
 Stop counting and reset to 0, as soon as „Channel01" is less than 5.*

Tip Used with TESTdrive (logger application) this recursive formula will result in valid values as the initial value for variables is set automatically. Used with IPEmotion (Acquisition > Calculations > Formulas) the respective formula has to be completed with the Valid function.

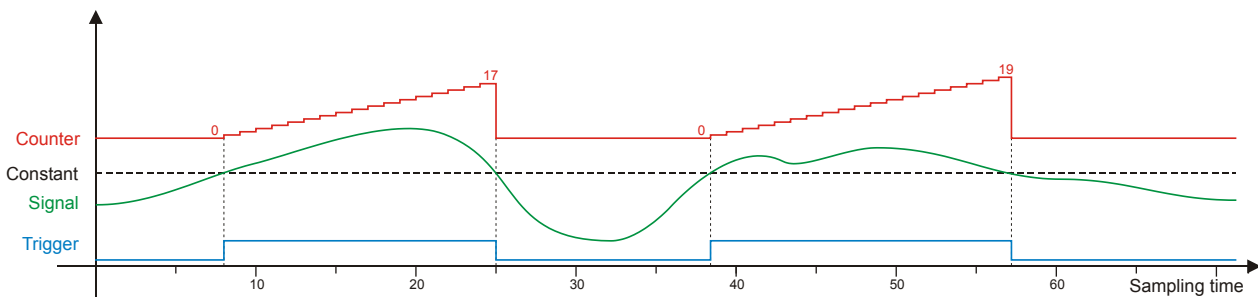

Validation check „VALID“

Syntax **VALID(x)**
VALID(x;y)

Description VALID checks the current value (of a channel or a calculation) for validity, i.e. if the variable's status is „invalid“ (NoValue).
 With the VALID(x) function the result is 1, as long as x is valid and changes to 0, as soon as the x has the status NoValue.
 With the VALID(x;y) function the result is x as long as x is a valid value. As soon as x will be an invalid value (NoValue) the result changes to y. In case y is a variable (instead of a constant) the result of VALID(x,y) will be NoValue, as soon as x, as well as, y are an invalid value.

Example VALID(„Channel01“) 1 if „Channel01“ ≠ NoValue, 0 if „Channel01“ = NoValue
 VALID(„Channel01“;4) „Channel01“ if „Channel01“ ≠ NoValue, 4 if „Channel01“ = NoValue

Tip When using a measurement value within a recursive formula ($x = x + y$) we recommend to use the VALID(x; y) function in order to avoid invalid values (NoValue). Even if the measurement signal becomes valid values, the recursive formula will not be calculated correctly, once a NoValue occurred.
 We recommend to use the VALID(x; y) function for any signal which serves as a trigger for a storage group. An invalid trigger signal could prevent the start of the data storage even if the trigger signal will become temporarily valid.

Mean value (averaging) „MEAN“

Syntax **MEAN(x)**
MEAN(x; n)

Description MEAN(x) continuously calculates the moving average from all valid measurement values.
 MEAN(x; n) berechnet continuously calculates the moving average from n previous measurement values.

Example MEAN(„Channel01“) moving average from all values of a measurement
 MEAN(„Channel01“; 10) moving average from 10 values at a time

Tip The diagram shows the differences of the MEAN functions with a rectangle signal (clock 5 Hz)

Square	red	origin signal
Mean Square	blue	moving average
Mean_5 Square	green	moving average from 10 values at a time

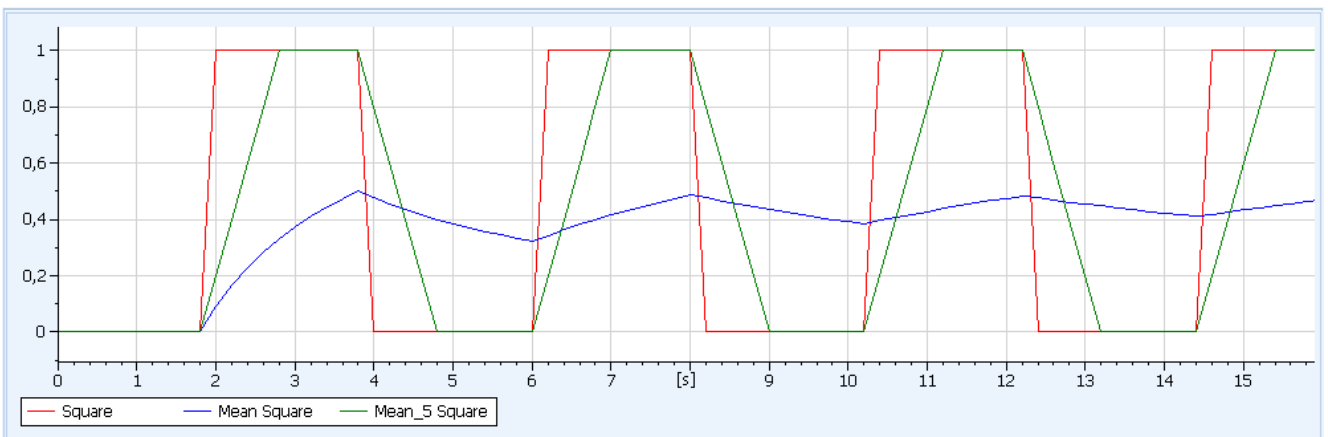

Linearization „LIN“

Syntax **LIN(Operand; x-Node01; y-Node01; x-Node02; y-Node02)**

Description Runs a linearization with user defined nodes. Between n = 2 and n = 16 nodes can be defined. The scaled values (Y-axis) are calculated from the original measurement values (X-axis) using factor and offset of the partial linear slope between two nodes.

Example LIN(„Channel01“; 0;-0,5; 2;1; 4;2; 8;2,5)

Tip The linearization enables a non-linear scaling (multipart scaling) used for physical graphs without having a mathematical equation.
 Using this multipart scaling an approximation of a mathematical equation is more precise as more nodes are used.

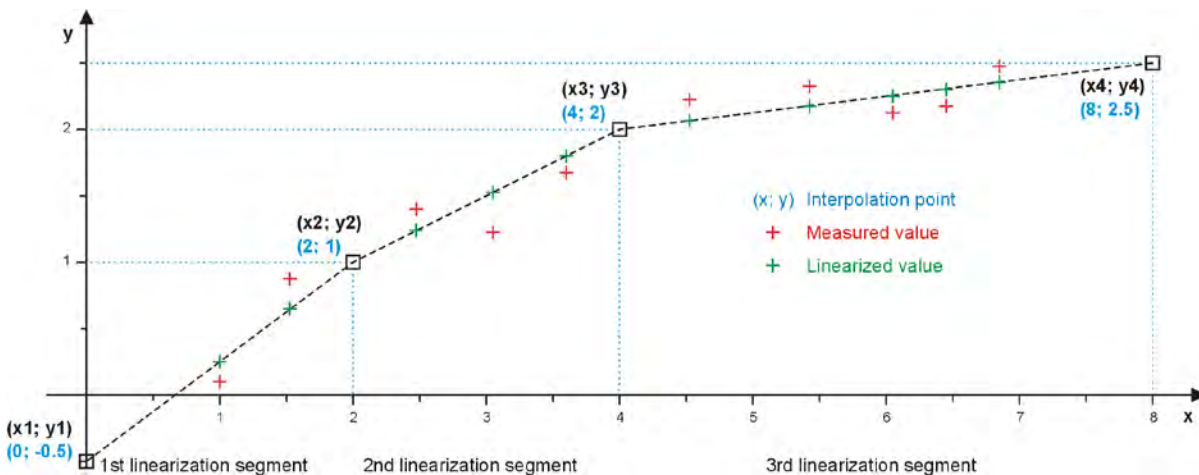

7.1.5 Calculation

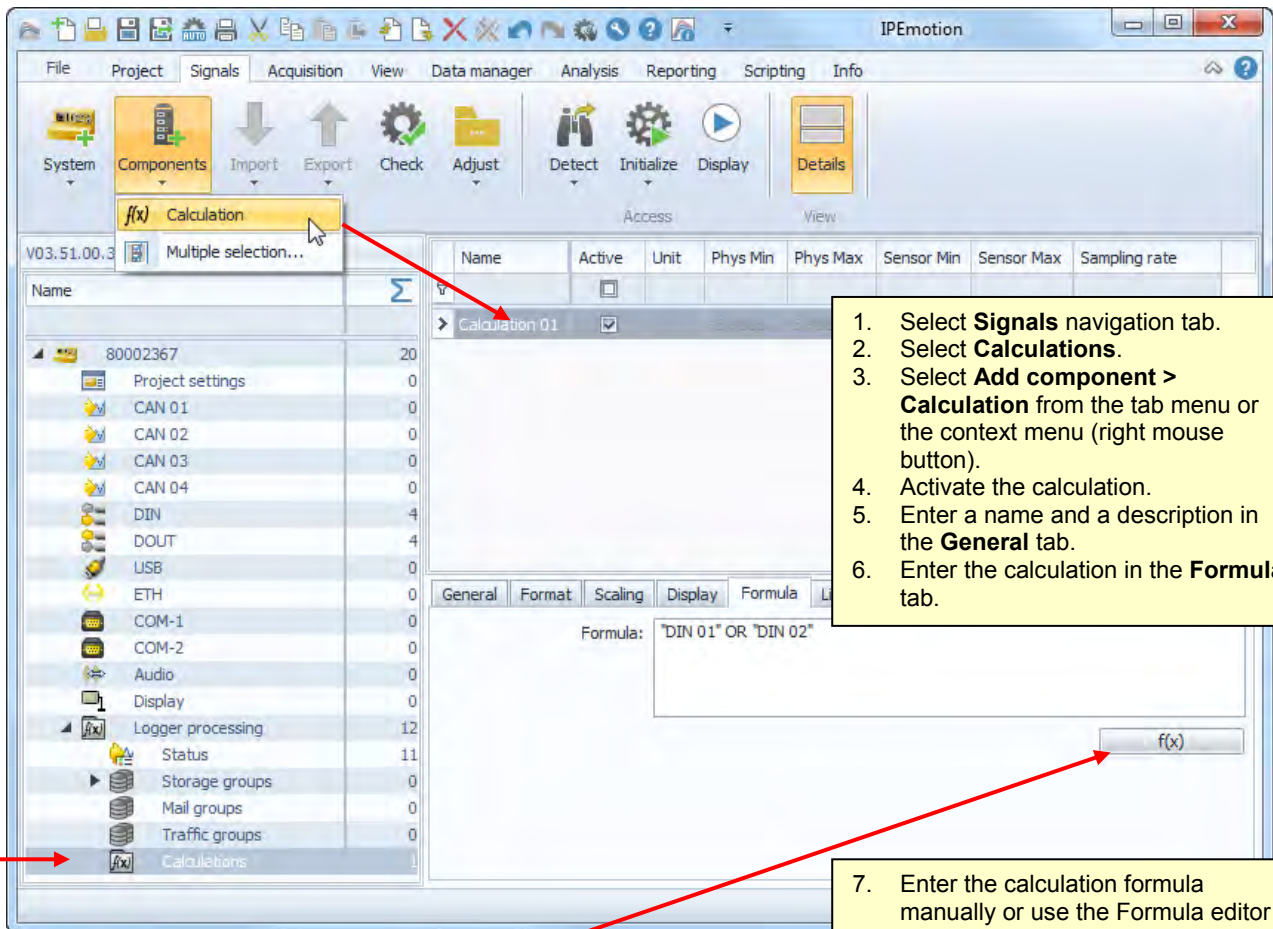

1. Select **Signals** navigation tab.
2. Select **Calculations**.
3. Select **Add component > Calculation** from the tab menu or the context menu (right mouse button).
4. Activate the calculation.
5. Enter a name and a description in the **General** tab.
6. Enter the calculation in the **Formula** tab.

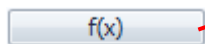

7. Enter the calculation formula manually or use the Formula editor f(x).
8. Move signals and operators in the entry field by using Drag&Drop.
9. Confirm with OK.
10. Enter the value range and the decimals in the Display tab.
11. Define additional limit values and/or a NoValue.

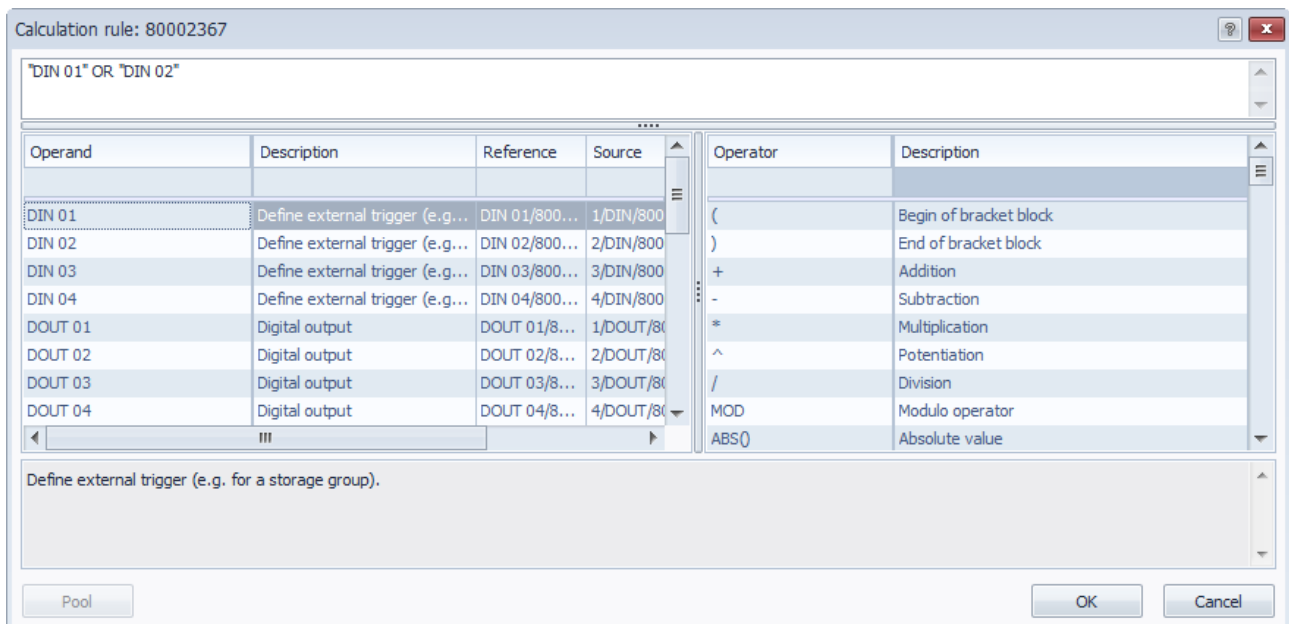

7.2 Digital inputs and outputs

7.2.1 Digital inputs

Name	Active	Unit	Phys Min	Phys Max
DIN 01	<input checked="" type="checkbox"/>		0	1
DIN 02	<input checked="" type="checkbox"/>		0	1
DIN 03	<input checked="" type="checkbox"/>		0	1
DIN 04	<input checked="" type="checkbox"/>		0	1

1. Activate the **Signals** tab.
2. Select **DIN** in the system overview.
3. Activate the desired digital inputs.
4. Enter a name and a description in the **General** tab.
5. Enter the value to be interpreted as NoValue in the **Format** tab. (Value out of the valid range)
6. Enter the value range and the decimals in the **Display** tab.
7. Define the lower and upper limit value with **Limit value**.
8. Enter the output/display of invalid value with **NoValue**.

7.2.2 Digital outputs

Name	Active	Unit	Phys Min	Phys Max
DOUT 01	<input checked="" type="checkbox"/>		0	1
DOUT 02	<input checked="" type="checkbox"/>		0	1
DOUT 03	<input checked="" type="checkbox"/>		0	1
DOUT 04	<input checked="" type="checkbox"/>		0	1

1. Activate the **Signals** tab.
2. Select **DOUT** in the system overview.
3. Activate the desired digital outputs.
4. Enter a name and a description in the **General** tab.
5. Enter the value to be interpreted as NoValue in the **Format** tab. (Value out of the valid range)
6. Enter the upper and lower acquisition range with **Scaling**.
7. Enter the value range and the decimals in the **Display** tab.
8. Define a formula to control the output with **Calculation**.
9. Define the lower and upper limit value with **Limit value**.

Sampling rate DOUT

The logger's digital outputs (DOUT) support a definable sampling rate (cycle rate) of up to 100 Hz.

Frequency output DOUT

If the frequency output is activated, a square wave voltage is sent. The signal frequency can be configured.

7.3 WakeOnCAN

The WakeOnCAN function switches the logger on as soon as the respective CAN bus is active, i.e. when messages are transferred.

7.3.1 ON via WakeOnCAN, OFF via Ignition 15

If there is no **Switch-off time** configured, the remote signal (e.g. terminal 15) must be active within the set timeout to permanently switch-on the logger. The logger is turned off if the remote signal is not received after the timeout. The logger stays in operation mode as long as the remote signal is high. As soon as remote is low, the **Follow-up time** will start and the logger is switched-off when data postprocessing is finished.

Bridge Pin 3 (CAN2/6-GND) → Pin 6 (PWR-GND)
 Bridge Pin 8 (WaOnCAN) → Pin 9 (UB-OUT+)

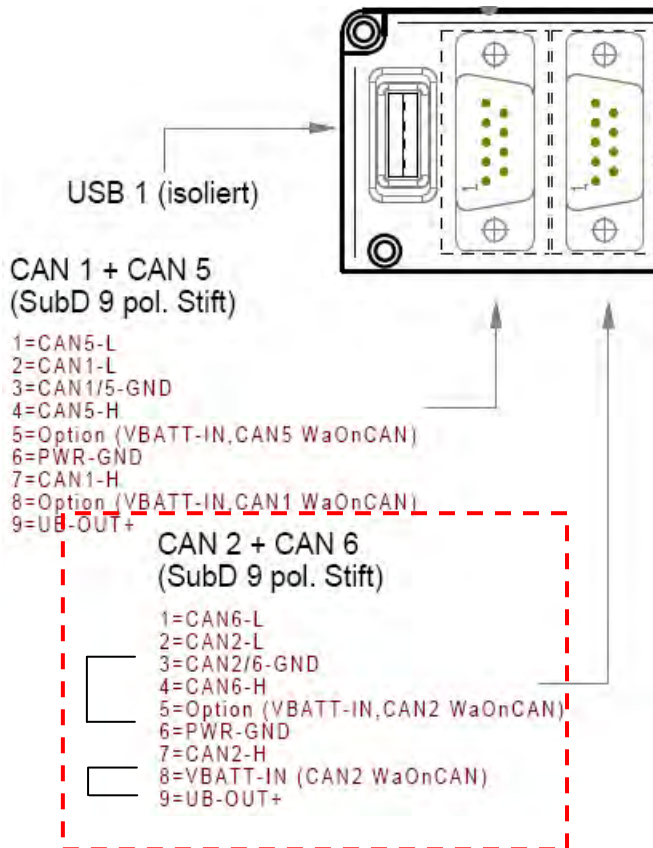
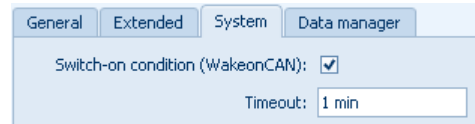

Depending on the CAN card/Port replicator, the WakeOnCAN function supports

- only at CAN 2,
- at CAN 2 and CAN 3
- at all CAN inputs (special version)!

7.3.2 ON via WakeOnCAN, OFF via Switch-off condition

With a configured Switch-off condition the Timeout setting has no influence. The logger stays in operation mode as long as the Switch-off condition is false.

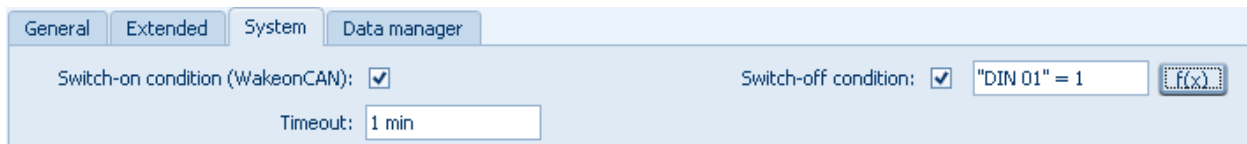

If a temporary remote signal (duration > 1 s) is identified in this mode, the Follow-up time starts with the falling signal edge and the logger is switched off (when postprocessing is finished), even with a false Switch-off condition.

7.4 CAN-Send: Output signals to CAN bus

The CAN-Send feature outputs measured signals, calculated channels and status signals using a common data rate up to 100 Hz. You can use the automatic CAN ID assignment or you may enter individual settings for each channel. Save the current signal settings to a CANdb file (*.dbc) for a quick and easy exchange with the external application using the CANdb export feature.

Requirements: **CAN board with FPGA version > 1.04.00**
 CAN-Send support for one CAN bus of the logger only

At least one CAN participant must be connected to the CAN interface to transfer data to the CAN. If this is not the case, TESTdrive reports the following:

E Error sending CAN message in CANSendWorkStation. Counter = 1



Just after successfully connecting a CAN device data output to the CAN bus is started, even when TESTdrive reports "Maximum number of error messages has been reached".

Creating CAN-Send, Adding channels

1. Highlight a CAN input (CAN 01)
2. Select **Components** and then **CAN-Send** from the tab menu or from the context menu (right mouse button).
3. Now, the system structure shows the new entry **CAN-Send** below the CAN input.
4. Select the channels you want to output to CAN bus.
5. If there are no active channels available, please activate some first and highlight **CAN-Send**. Select **Components > Channels** from the tab menu or from the context menu (right mouse button).

CAN settings

Sending frequency common output rate of all signals: 0.5/ 1/ 2/ 5/ 10/ 20/ 50/ 100 Hz

If the data output rate is greater than or equal to the acquisition rate of source channel, this error report is written to the log file:

```
D ERROR in CCANSendWorkStation::Put() Fifo full!
```

- First CAN ID** Define the first CAN ID used for automatic CAN ID placing
- Automatic CAN ID placing** Padding of CAN messages with selected signals and automatic CAN ID assignment to the respective message
- Send counter** Counts up the sending tasks
- Send counter start bit** Start bit used for the send counter value within the CAN message
- Send counter bit count** Data length of the send counter value
- Send counter data format** Data format of the send counter value (Intel, Motorola forward)



With automatic CAN ID placing, the first CAN message contains the value of the send counter (depending on data format byte 1 to 4).

Monitoring the send counter by the receiver is a simple way to verify a correct CAN communication.

Channel settings

- CAN message** Name of the CAN message
- CAN ID** Identifier of the CAN message (standard ID and extended ID supported)
- CAN LSB** Start bit within the CAN message of the signal to be output

Extended settings (Expert mode only)

- Start bit** Start bit within the CAN message of the signal to be output
- Bit count** Number of bits per signal within the CAN message
- Data format** Data format of the signal value (Intel, Motorola forward)

Exporting the settings to a CANdb

Export the current CAN send settings to a CANdb file after you finished the system configuration. This makes it easy to configure an external CAN device (notebook, or CAN data display) in order to acquire/display the signals streamed by the logger.

The screenshot shows the IPETRONIK software interface. On the left, the system structure is visible, with 'CAN-Send' highlighted. A context menu is open over 'CAN-Send', and the 'Export' option is selected, showing a sub-menu with 'CANdb export' highlighted. The 'Settings' dialog box is also visible, showing the 'Sending frequency' set to 10 Hz and 'First CAN ID' set to 100.

Channel	Index	Active	Unit	Sampling rate	CAN message	CAN ID [hex]	Start bit
57801482_1	1	<input checked="" type="checkbox"/>	°C	10 Hz	Message_100	100	32
57801482_2	2	<input checked="" type="checkbox"/>	°C	10 Hz	Message_100	100	48
58700695_1	3	<input checked="" type="checkbox"/>	V	100 Hz	Message_101	101	0
DIN 01	4	<input checked="" type="checkbox"/>		1 Hz	Message_101	101	16
DIN 02	5	<input checked="" type="checkbox"/>		1 Hz	Message_101	101	32
Delta T	6	<input checked="" type="checkbox"/>	°C	10 Hz	Message_101	101	48

1. Highlight **CAN-Send** from the system structure at the left side.
2. Select **Export > CANdb export** from the tab menu or from the context menu (right mouse button)..
3. Select destination and file name (*.dbc) to save your export.
4. Confirm by clicking the **Save** button.

7.5 Log file output via Hyperterminal

The logger status messages can be displayed online with a RS232 PC or notebook connection. The MLOG.ht file is copied into the following directory:

C:\Documents and Settings\[user]\Startmenu\Programs\Accessories\Communication\HyperTerminal\....

Prior to this, a hyperterminal connection must be created.

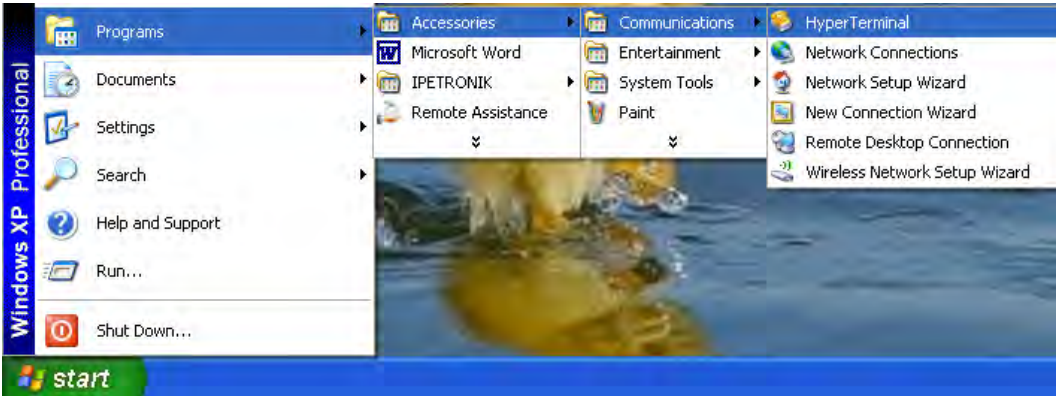

Or create a new hyperterminal connection:



The following components are required for the connection of M-LOG and PC:

for PCs with serial interface:

1 x USB to RS232 converter

1 x Null modem cable

1 x Gender Changer

for PCs without serial interface:

2 x USB to RS232 converter

1 x Null modem cable

1 x Gender Changer

The components for PCs without serial interface are available as an optional package (M-LOG-OPT-086).

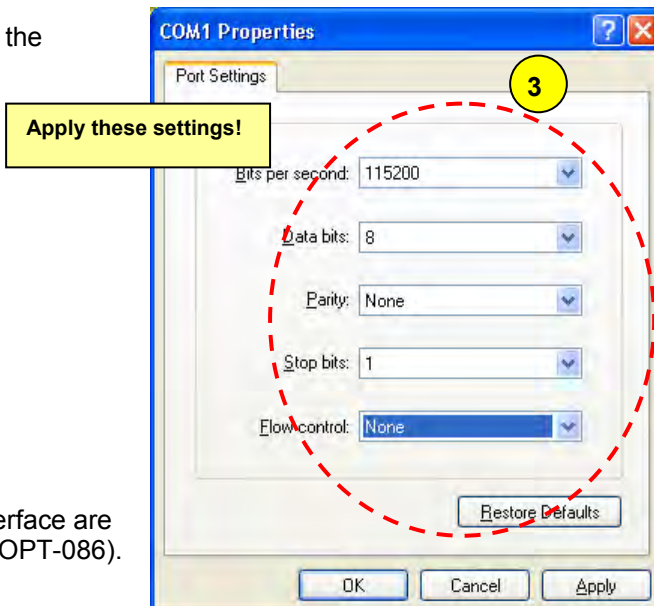

7.6 Send e-mail with status information

If this function is activated and the logger has an internet connection (LAN, WiFi, modem), it sends a status e-mail after acquisition stop with the following content:

- ▶ serial number and number of the current acquisition in subject line,
- ▶ attached log file
- ▶ attached measurement status file if activated
- ▶ attached STG file (Statistic Group, resp. Min-Max list) if activated

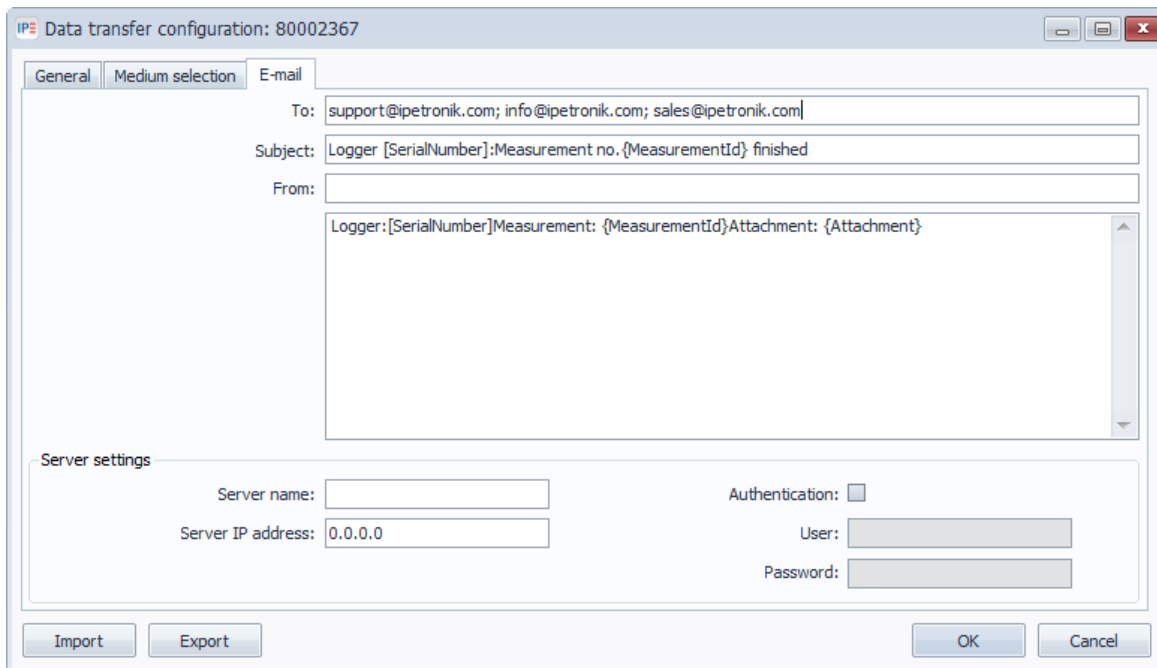
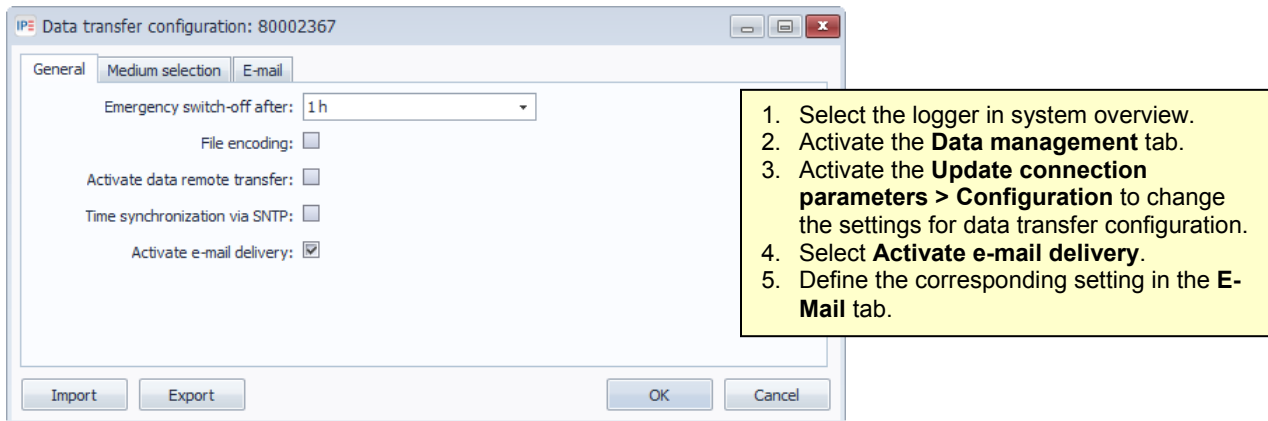

To	E-mail address of recipient
Subject	Subject line for serial number and measurement number file
From	E-mail address of sender (any text)
Description field	Description of serial number, measurement file number and attachment
Server IP address	IPE address of outgoing mail server (to e-mail account, e.g. smtp.mail.provider.com) for sending
Server name	Alternative input of server name of outgoing mail server
Authentication	Access authorization to user e-mail account
User	User name
Password	Password

7.7 Output messages to CAN / LIN

With the Logger PlugIn V03.21.00 / TESTdrive 3.21 and higher an output of user defined messages to CAN bus or LIN bus is supported.

The output timing can be selected from:

- one-time, at start measurement,
- one-time, at stop measurement,
- cyclical every x ms.

An external file with the *.DAT extension is used to configure the settings for the messages.

A sample file is available from:

c:\Programs\IPETRONIK\IPEmotion PlugIn IPETRONIK LOG V03.xx.xx\Data\Channel.dat

The header of this files contains detailed information regarding to the usage of the parameters.

The screenshots below show the implementation of the external file in IPEmotion configuration.

1. Select **Data processing** in the left Systems overview.
2. Select **Add components > External programs** from the tab menu or from the context menu.
3. The new entry **External programs** has been added to **Data processing**.

4. Select **External programs** in the left Systems overview.
5. Select **Add components > External programs** from the tab menu or from the context menu.
6. Chose additional settings in the tab **Extended**.

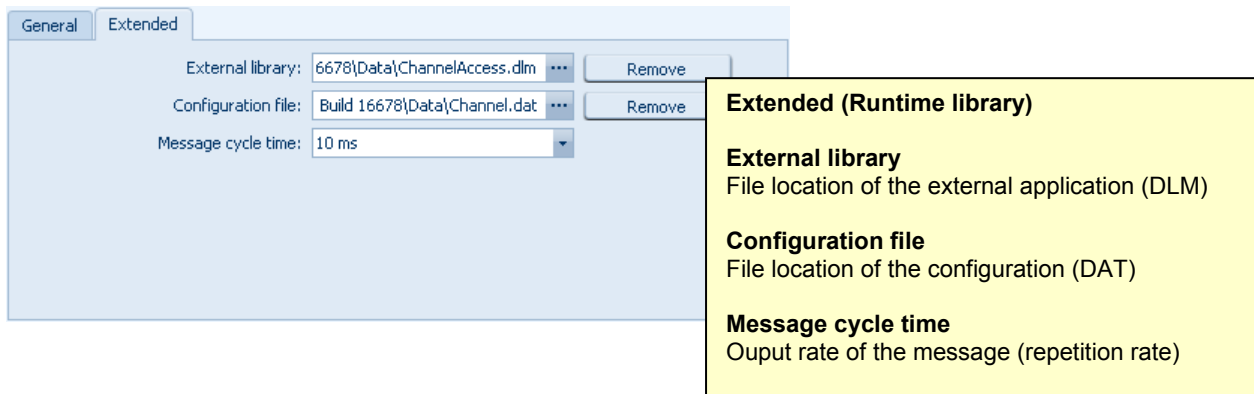

Extended (Runtime library)

External library
File location of the external application (DLM)

Configuration file
File location of the configuration (DAT)

Message cycle time
Output rate of the message (repetition rate)

Example Offset adjust for IPETRONIK modules connected to the logger's CAN input

The message output feature offers the possibility to broadcast an offset adjust command to IPETRONIK CAN modules with adjust function.

The sample file **OffAddStart.dat** contains the adjust commands for task Manual and Group 1-4. The sample shows a manual adjust on CAN 01 with a baud rate of 500 kBit/s, executed with a time delay of 2.5 seconds from start measurement.

Brief description of the parameters (see header of the sample Channel.dat for detailed settings):

// Hardware initialization <---**Basic setting of CAN/LIN input**

[Init]

// Channel, ChnType, ChnIndex, ChnMode, Baudrate

CAN0, 1, 0, 1, 500000

<-----**ChnType LIN=2 /CAN=1, ChnIndex Nr 0...11=Input, ChnMode 29Bit=2 11Bit=1 / Baud rate**

// List of messages (send/receive)

[Messages]

// Name, ID, Length Bytes <----- **ID CAN/LIN -ID; Length= Number of bytes; Bytes = Message**

//

Manuell_1,	0x0, 8,	0x00, 0x91, 0x02, 0xCA, 0x3F, 0x00, 0x80, 0x80	<---- Manual
Manuell_2,	0x0, 8,	0x00, 0x91, 0x02, 0xCA, 0x3F, 0x00, 0xC0, 0x81	
Manuell_3,	0x0, 8,	0x00, 0x91, 0x02, 0xCA, 0x3F, 0x00, 0x40, 0x8C	
Manuell_4,	0x0, 8,	0x00, 0x91, 0x02, 0xCA, 0x3F, 0x00, 0xC0, 0x8D	
Manuell_5,	0x0, 8,	0x00, 0x91, 0x02, 0xCA, 0x3F, 0x00, 0x00, 0x8E	
Group1_1,	0x0, 8,	0x00, 0x91, 0x02, 0xC5, 0x3F, 0x00, 0x80, 0x80	<----- Group 1
Group1_2,	0x0, 8,	0x00, 0x91, 0x02, 0xC5, 0x3F, 0x00, 0xC0, 0x81	
Group1_3,	0x0, 8,	0x00, 0x91, 0x02, 0xC5, 0x3F, 0x00, 0x40, 0x8C	
Group1_4,	0x0, 8,	0x00, 0x91, 0x02, 0xC5, 0x3F, 0x00, 0xC0, 0x8D	
Group1_5,	0x0, 8,	0x00, 0x91, 0x02, 0xC5, 0x3F, 0x00, 0x00, 0x8E	
Group2_1,	0x0, 8,	0x00, 0x91, 0x02, 0xC6, 0x3F, 0x00, 0x80, 0x80	<----- Group 2
Group2_2,	0x0, 8,	0x00, 0x91, 0x02, 0xC6, 0x3F, 0x00, 0xC0, 0x81	
Group2_3,	0x0, 8,	0x00, 0x91, 0x02, 0xC6, 0x3F, 0x00, 0x40, 0x8C	
Group2_4,	0x0, 8,	0x00, 0x91, 0x02, 0xC6, 0x3F, 0x00, 0xC0, 0x8D	
Group2_5,	0x0, 8,	0x00, 0x91, 0x02, 0xC6, 0x3F, 0x00, 0x00, 0x8E	
Group3_1,	0x0, 8,	0x00, 0x91, 0x02, 0xC7, 0x3F, 0x00, 0x80, 0x80	<----- Group 3
Group3_2,	0x0, 8,	0x00, 0x91, 0x02, 0xC7, 0x3F, 0x00, 0xC0, 0x81	
Group3_3,	0x0, 8,	0x00, 0x91, 0x02, 0xC7, 0x3F, 0x00, 0x40, 0x8C	
Group3_4,	0x0, 8,	0x00, 0x91, 0x02, 0xC7, 0x3F, 0x00, 0xC0, 0x8D	
Group3_5,	0x0, 8,	0x00, 0x91, 0x02, 0xC7, 0x3F, 0x00, 0x00, 0x8E	
Group4_1,	0x0, 8,	0x00, 0x91, 0x02, 0xC8, 0x3F, 0x00, 0x80, 0x80	<----- Group 4
Group4_2,	0x0, 8,	0x00, 0x91, 0x02, 0xC8, 0x3F, 0x00, 0xC0, 0x81	
Group4_3,	0x0, 8,	0x00, 0x91, 0x02, 0xC8, 0x3F, 0x00, 0x40, 0x8C	
Group4_4,	0x0, 8,	0x00, 0x91, 0x02, 0xC8, 0x3F, 0x00, 0xC0, 0x8D	
Group4_5,	0x0, 8,	0x00, 0x91, 0x02, 0xC8, 0x3F, 0x00, 0x00, 0x8E	

[Conditions]

// Name Condition

// Messages which have to be send at measurement start <---- **The output sequence is defined by the sequence of the list**

[OnStart]

// Time, Channel, Message

2500000, CAN0, Manuell_1

<-- 2500000 µs after Start /CAN input/ To adjust a group, replace with Group1_1

2500000, CAN0, Manuell_2

<-- 2500000 µs after Start /CAN input/ To adjust a group, replace with Group1_2

2500000, CAN0, Manuell_3

<-- 2500000 µs after Start /CAN input/ To adjust a group, replace with Group1_3

2500000, CAN0, Manuell_4

<-- 2500000 µs after Start /CAN input/ To adjust a group, replace with Group1_4

2500000, CAN0, Manuell_5

<-- 2500000 µs after Start /CAN input/ To adjust a group, replace with Group1_5

Refer to the header of the *.DAT file for further parameter settings.

7.8 Event controlled measurement

7.8.1 Possibilities for data acquisition

For measurement signal acquisition and storage in electronic systems, analog signals need to be digitalized, first. This is done by taking discrete measuring values from the continuous signal sequence (Sample & Hold) and recording them cyclically. Cyclic recording is also used for native digital signals, e.g. for measuring data packages from bus systems.

For some applications, it is useful to not record CAN bus data cyclically but event-controlled.

In the following, the basic features of both data acquisition types are described.

7.8.2 Cyclic data recording of continuous signals

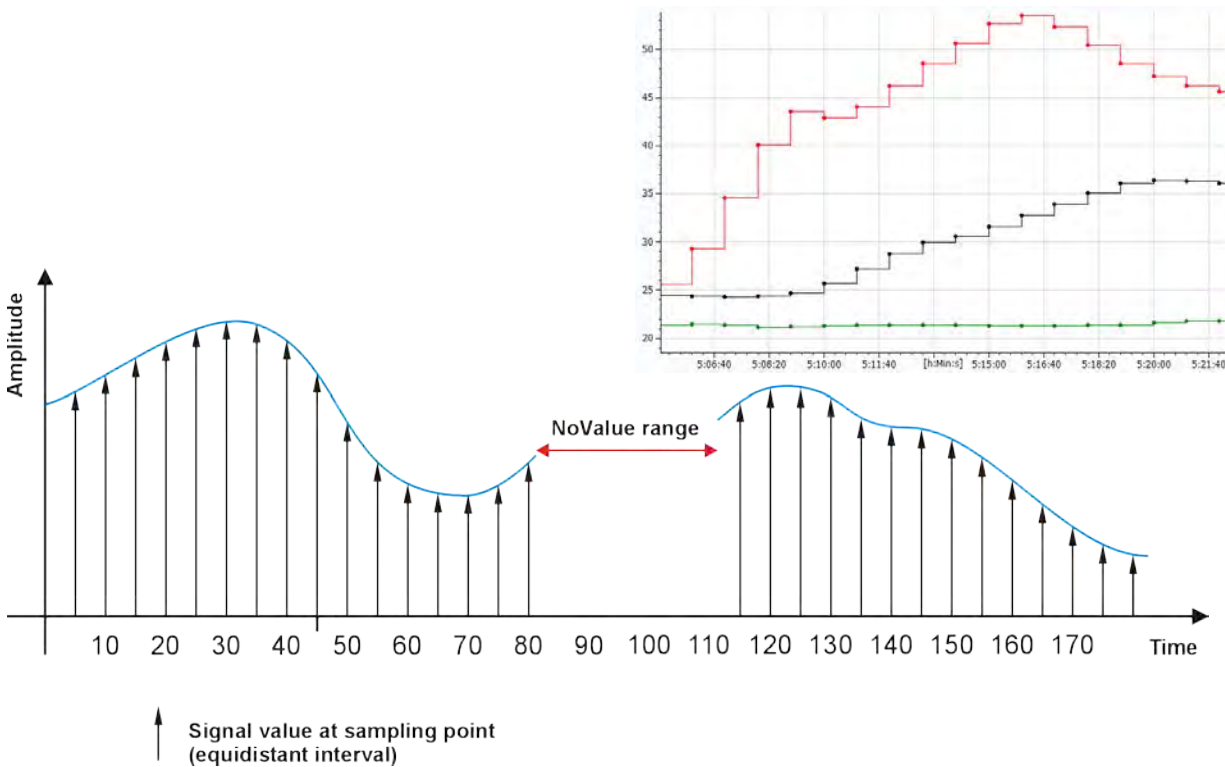

Features of cyclic data recording (PlugIn IPETRONIK-LOG)

- ▶ time-based recording in a fixed time grid, e.g. sampling rate 100 Hz
- ▶ different storage groups allow different data rates for recording
- ▶ individual time channel for each storage group in measurement data set
- ▶ continuous recording in equidistant intervals
- ▶ suitable for analog signals
- ▶ improved time accuracy due to increased sampling rate (oversampling)
- ▶ clear comparability of different signals using a synchronization clock (Master Sample Clock MSC)
- ▶ protocol measurement during data acquisition using bus systems is possible (CCP, XCP, FlexRay, ...)
- ▶ bus signals are allocated to the respective time grid (sampling rate)
- ▶ (time) differentiation of two signals is not possible in the time grid
- ▶ sampling points without real signal value are indicated with "NoValue" (invalid) in data set

7.8.3 Event-controlled data recording of bus signals

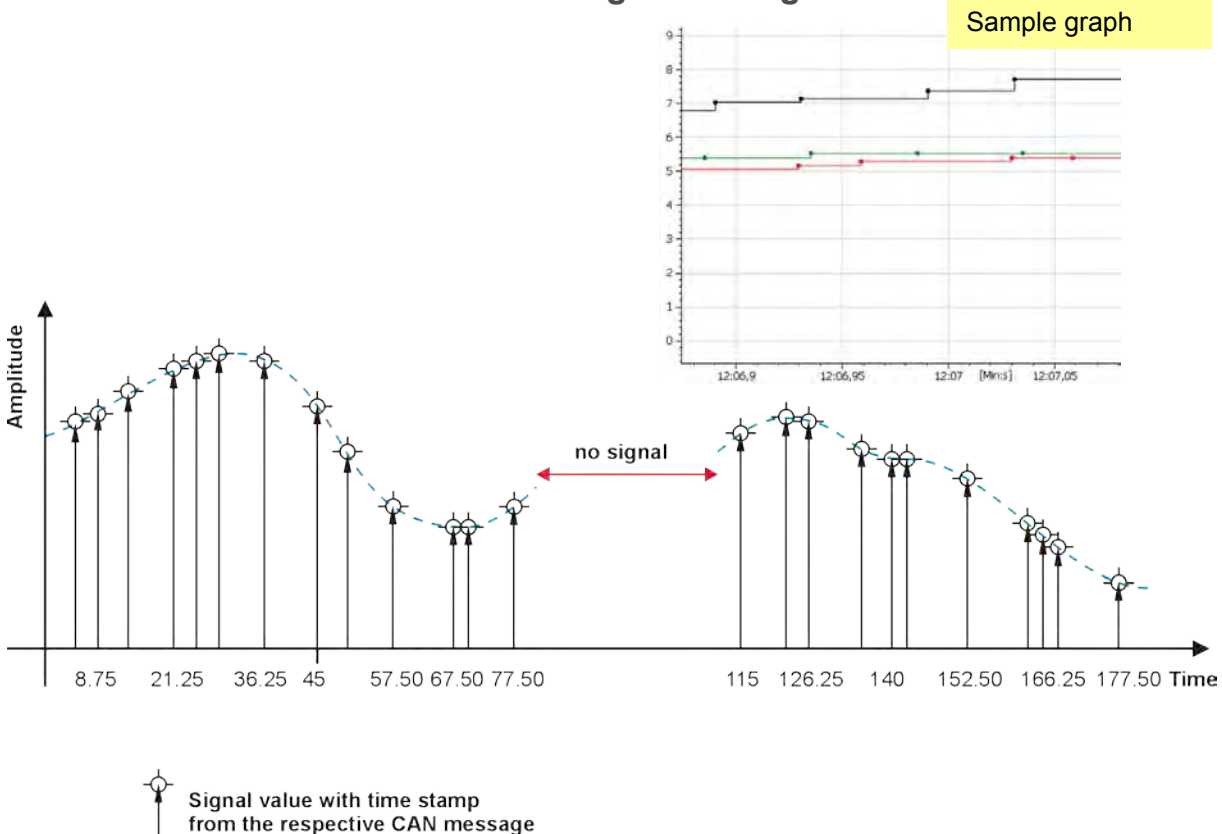

Features of event-controlled data recording (PlugIn IPETRONIK-LOG)

- ▶ event-controlled recording without fixed time grid for bus signals, e.g. CAN bus
- ▶ all signals of a message are provided with an exact time stamp, as with traffic measurement
- ▶ individual time channel for each message in measurement data set
- ▶ discontinuous recording without defined time grid
- ▶ suitable for measurement of bus signal differences and of sporadic or single signals
- ▶ measuring values in different messages feature different time stamps > in the result graph, the time stamps do not lie on the same x-values any more
- ▶ no protocol measurement possible (CCP, XCP; FlexRay, ...)
- ▶ determination of exact time difference between signals (difference between time stamps)
- ▶ "NoValue" entries indicating the absence of signals are avoided

7.8.4 Setting up event-controlled data recording (PlugIn IPETRONIK-LOG)

General

Event-controlled measurement, available from TESTdrive 3.51.00 onwards, features the benefits of signal measurement and traffic measurement:

Signal selection is already interpreted (name, scaling, unit,...). Yet, measurement is not performed cyclically but with "real" time stamp. Signals are only recorded if they really are present on the CAN bus. Using the exact time stamp.

Event-controlled measurement appears like a signal measurement on the configuration surface and in the measurement file. Loggers process the respective storage groups in traffic measurement mode.

Configuration settings

The respective signals must not be recorded cyclically.

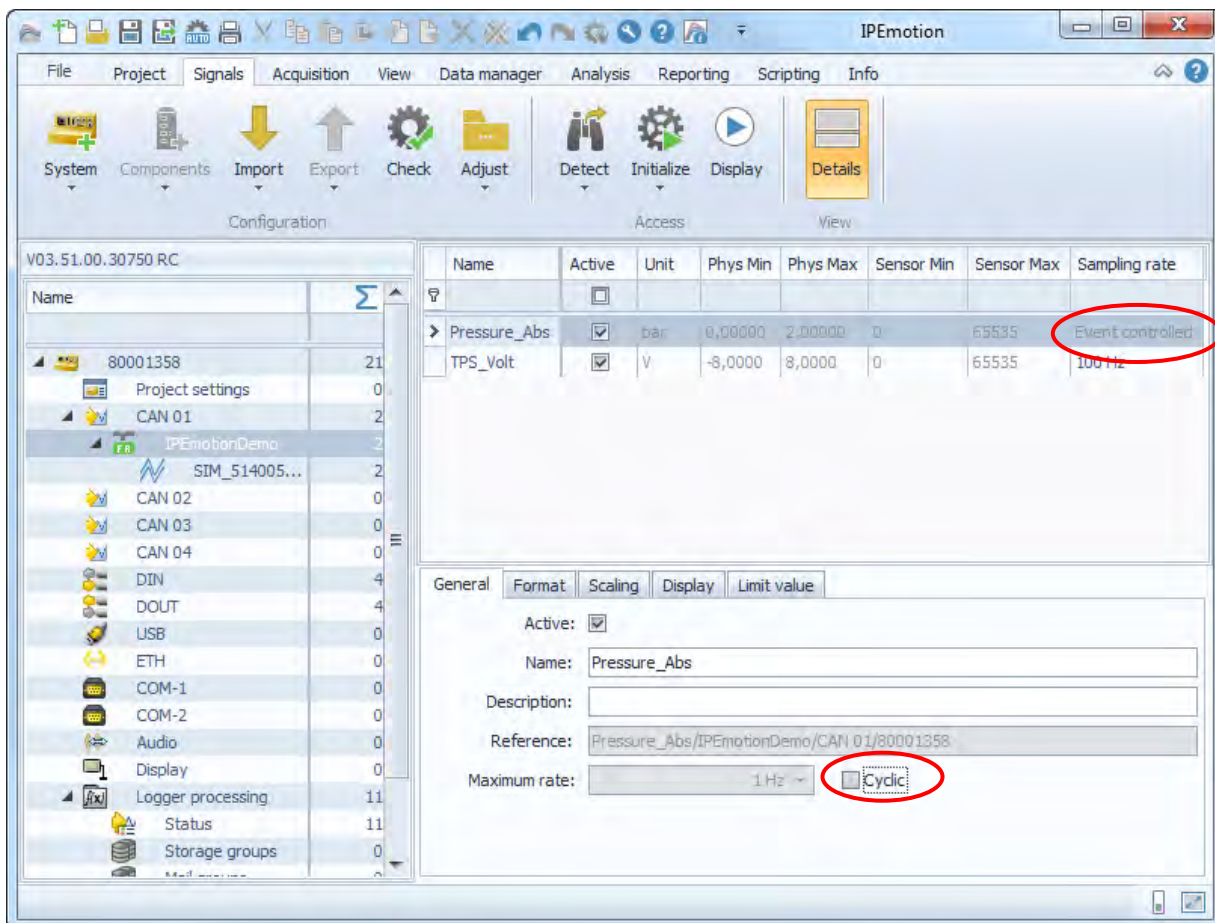

In the storage group, the storage rate has to be set **From channel**. It should not be a fixed storage rate.

As a result, sampling rate is **Event controlled** and storage rate is **Auto**.

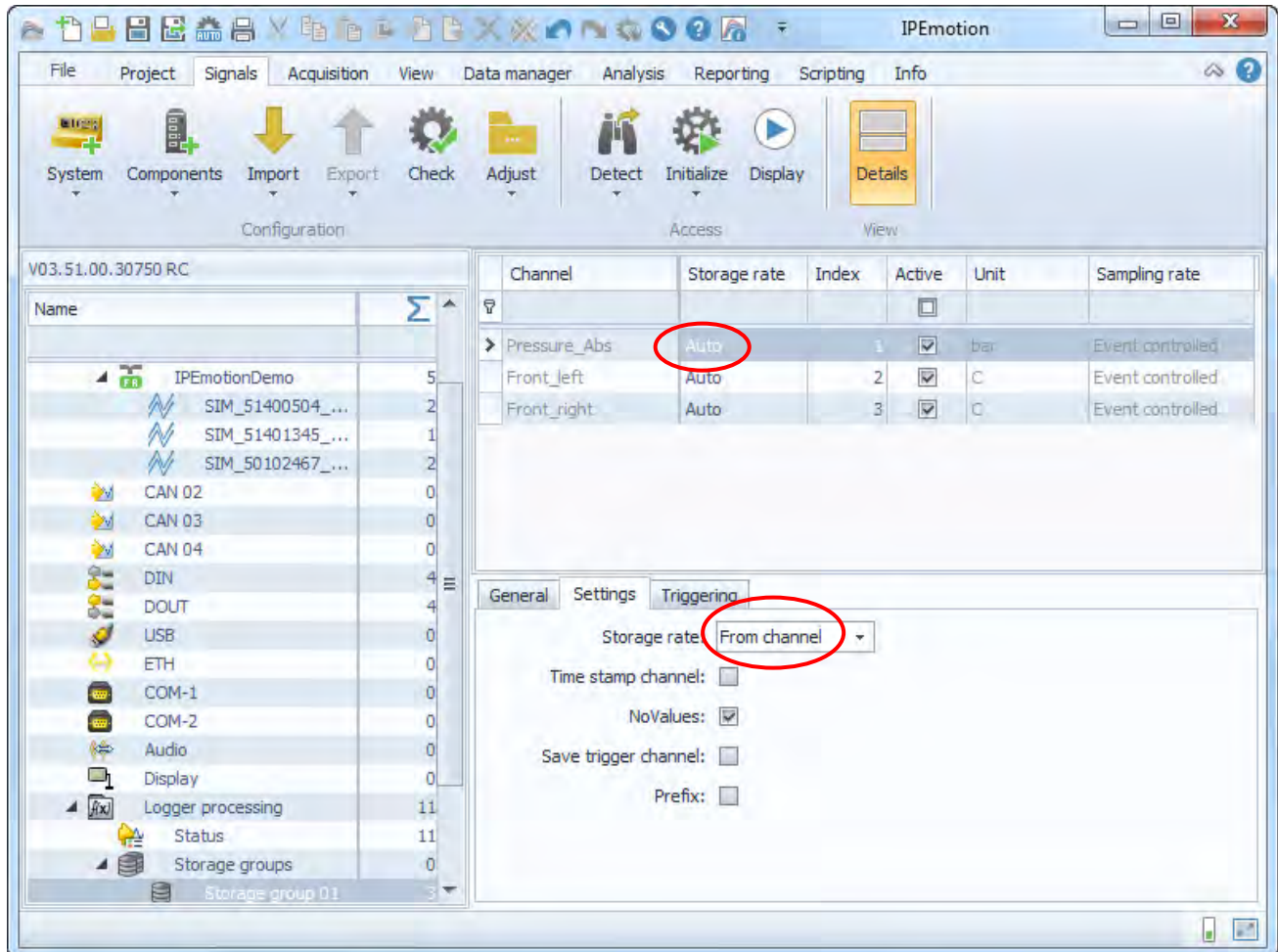

Measurement file

Event-based signals are recorded in an event-based storage group TS_xxxxx.DAT. A signal-based storage group DOxxxxxx.DAT with cyclic storage rate cannot contain event-based signals since event-controlled or cyclic recording types are properties of signals and not of storage groups.

There are two types DAT files:

- ▶ DOxxxxxx.DAT for storage groups with cyclic storage rate and signals with fixed, cyclic sampling rate
- ▶ TSxxxxxx.DAT for storage groups with event-controlled, non-cyclic signals without fixed sampling rate

Conclusions

- ▶ Each message that is recorded event-controlled receives an individual time channel
- ▶ In DAT format of the logger measurement each message creates an own internal storage group (TSxxxxxx.DAT)
- ▶ In order to ensure strong system performance, it is useful to check the number of event-controlled measuring signals according to the application (necessary number of storage groups).

Measurement data set

In table view, it becomes obvious that time intervals are not equidistant any more and messages (signals) are no more identical. Each value is measured and saved at the time it actually occurs on the CAN bus.

Index	Time BAD-IP_26_8090...	Speed_mph_3 BAD-IP_26_80900023_...	Time BAD-IP_26_80...	Speed_mph_2 BAD-IP_26_809000...	Time BAD-IP_26_8...	Speed_mph_1 BAD-IP_26_809000...
4934	240,898994	2,53171491622925	246,98334	2,76187086105347	247,638911	2,41663670539856
4935	240,97946	2,53171491622925	247,033392	2,76187086105347	247,688266	2,41663670539856
4936	240,999118	2,53171491622925	247,084021	2,76187086105347	247,738998	2,53171491622925
4937	241,079566	2,41663670539856	247,123429	2,76187086105347	247,788547	2,76187086105347
4938	241,098938	2,41663670539856	247,173719	2,64679265022278	247,848182	2,76187086105347
4939	241,179301	2,41663670539856	247,223519	2,64679265022278	247,88858	2,53171491622925
4940	241,260063	2,30155897140503	247,273564	2,64679265022278	247,948201	2,18648099899292
4941	241,289621	2,30155897140503	247,323497	2,64679265022278	247,998492	2,18648099899292
4942	241,318031	2,30155897140503	247,373666	2,64679265022278	248,058398	2,18648099899292
4943	241,389505	2,30155897140503	247,423454	2,64679265022278	248,088545	2,41663670539856
4944	241,41812	2,30155897140503	247,473635	2,64679265022278	248,148236	2,53171491622925
4945	241,489817	2,18648099899292	247,52342	2,64679265022278	248,188478	2,30155897140503
4946	241,508455	2,18648099899292	247,573539	2,53171491622925	248,248249	2,18648099899292
4947	241,579502	2,18648099899292	247,62349	2,53171491622925	248,288752	2,30155897140503
4948	241,608423	2,18648099899292	247,67366	2,53171491622925	248,348459	2,41663670539856
4949	241,679551	2,18648099899292	247,723447	2,53171491622925	248,388811	2,41663670539856
4950	241,708274	2,07140302658081	247,773624	2,53171491622925	248,448397	2,41663670539856
4951	241,779567	2,07140302658081	247,823407	2,53171491622925	248,48874	2,53171491622925
4952	241,808086	2,07140302658081	247,873659	2,53171491622925	248,548416	2,64679265022278
4953	241,879497	2,07140302658081	247,923452	2,41663670539856	248,588424	2,87694883346558
4954	241,908284	2,07140302658081	247,973633	2,41663670539856	248,638883	3,10710477828979
4955	241,979364	2,07140302658081	248,033872	2,41663670539856	248,688384	3,45233845710754

7.8.5 Practical example: Determination of the latency of two signals

Task

An electronic system (ECU) receives messages via CAN bus (input signals) and sends them out again on the CAN bus, e.g. as forwarding or after calculation (output signals).

Processing time = response time of the system is to be determined.

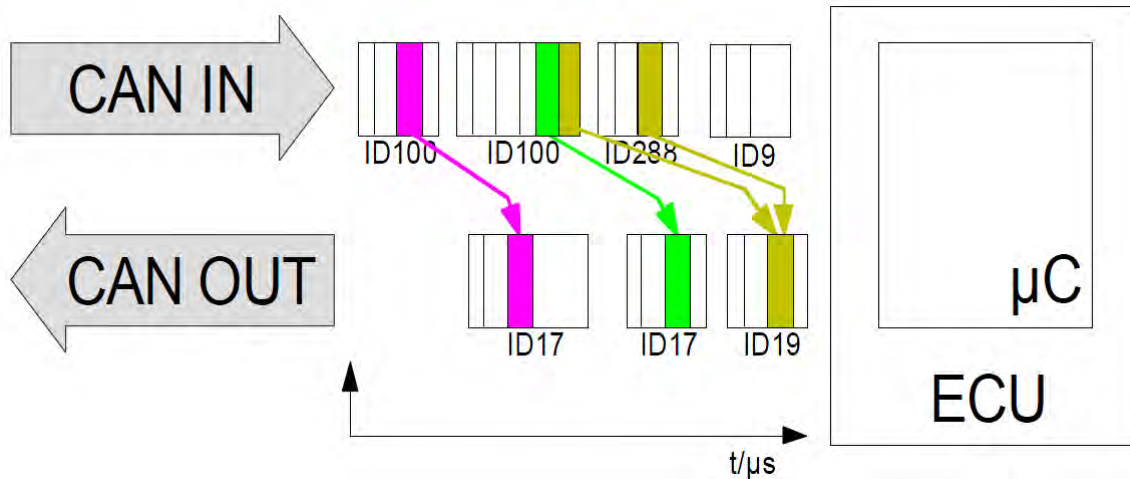

Realization

The response time results from the time difference between input and respective output signal. Since both incoming and outgoing CAN messages are provided with a time stamp, the exact time difference can be determined through event-controlled measurement.

Advantages:

- ▶ No event gets lost (not fixed to a sampling rate or to several signals within one sampling interval).
- ▶ Unique time stamps from TESTdrive are used.
- ▶ Event-controlled measurement is based on traffic measurement > traffic group.
- ▶ Each ID generates an event with a new signal value.

8 Options (license required)

8.1 Hardware options (internal)

M-LOG and S-LOG can be extended by 3 slots with different IPETRONIK cards. Max. 3 cards can be combined depending on the assignment to the extension slots and the port replicator. The active CAN cards support a highly accurate 1 μ s time stamp. This time stamp is synchronous for all inputs within a card.

8.1.1 CAN cards

The following CAN cards with galvanically isolated high speed inputs acc. to ISO 11898-2 and low speed acc. to ISO 11992-1 are available:

- ▶ 2 x CAN High Speed, WakeOnCAN functionality, active data preprocessing and message buffer
- ▶ 4 x CAN High Speed, WakeOnCAN functionality, active data preprocessing and message buffer
- ▶ 3 x CAN High Speed, WakeOnCAN functionality, active data preprocessing and message buffer + 1 x CAN Low Speed (5 V, fault-olerant)
- ▶ 3 x CAN High Speed, WakeOnCAN functionality, active data preprocessing and message buffer + 1 x CAN Low Speed (24 V)

8.1.2 CAN / LIN cards

The following CAN LIN combination cards with galvanically isolated inputs are available:

- ▶ 2 x CAN High Speed, WakeOnCAN functionality, active data preprocessing and message buffer + 2 x LIN
- ▶ 2 x CAN Single Wire (GMW 3089 V2.1) + 2 x LIN
- ▶ 1 x CAN Single Wire (GMW 3089 V2.1) + 1 x CAN High Speed, WakeOnCAN functionality, active data preprocessing and message buffer + 2 x LIN

8.1.3 Ethernet cards

The following ETH card with galvanically isolated inputs is available:

- ▶ 2 x ETH 10/100 MBit LAN, e.g. as input via XCPonEthernet or FlexRay-Ethernet converter

8.2 Software options

8.2.1 Import signal description files

IPEmotion supports the import and management of signal descriptions from CANdb (*.dbc), ASAP2 files (*.a2l), and diagnostic description files (*.idf).

The contents are read and managed by importing the original files into a database (Microsoft SQL-Server). The original files are therefore not longer required. Please note at updating the CAN system or the control unit that the current description file must be reloaded to update signal descriptions, if required. An export of the signal settings changed with IPEmotion into the original description file is not possible.

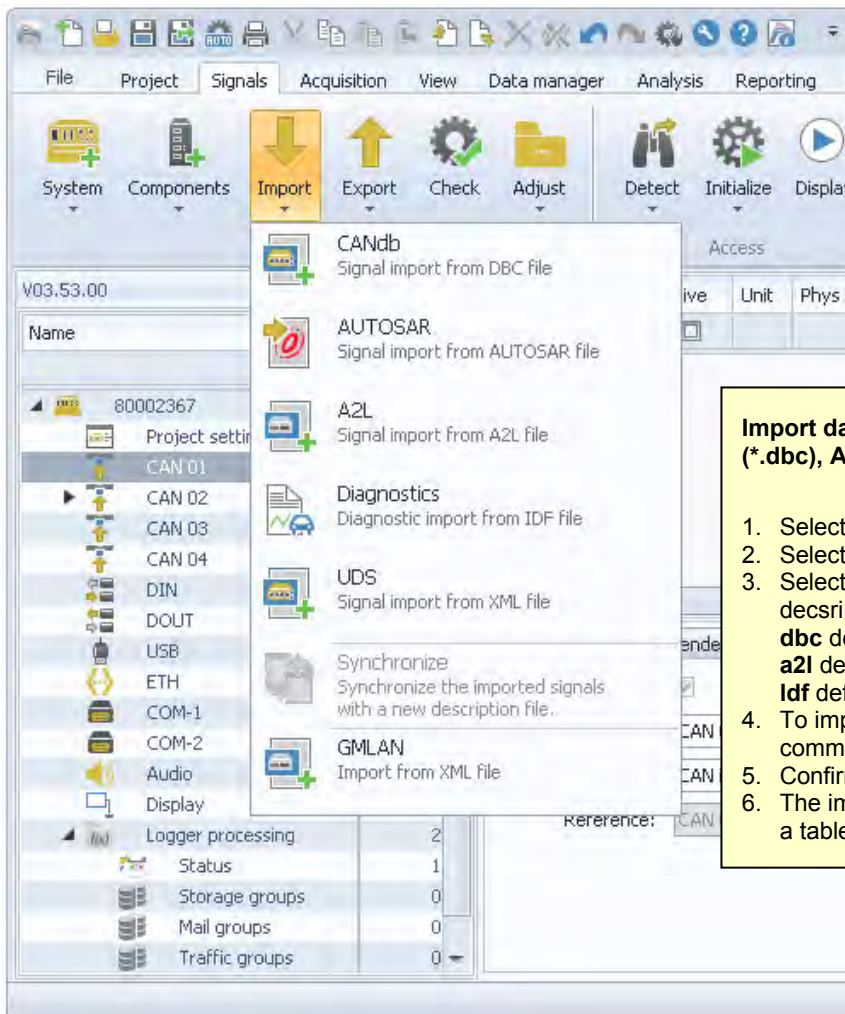

Import data from a description file: CANdb (*.dbc), ASAP2 (.a2l), LINdb (*.ldf)

1. Select a CAN input (here CAN 01).
2. Select **Import** from the tool bar.
3. Select the directory and the type of the description file to open.
dbc defines CANdb files
a2l defines ASAP2 files
ldf defines LINdb files (LIN Description File)
4. To import an A2L file, select the communication protocol first
5. Confirm with OK.
6. The imported signals (Pool) are displayed in a table.



General signals at CAN 01 cannot be configured if CAN 01 is already used for IPETRONIK devices!

Importing signal descriptions from ASAP2 or CANdb is the easiest and most secure method to configure signals.

*Signals can also be manually created at an input (without description file). Select **Add components > Standard CAN** from the tool bar within the **Signals** navigation tab.*

Import CANdb file

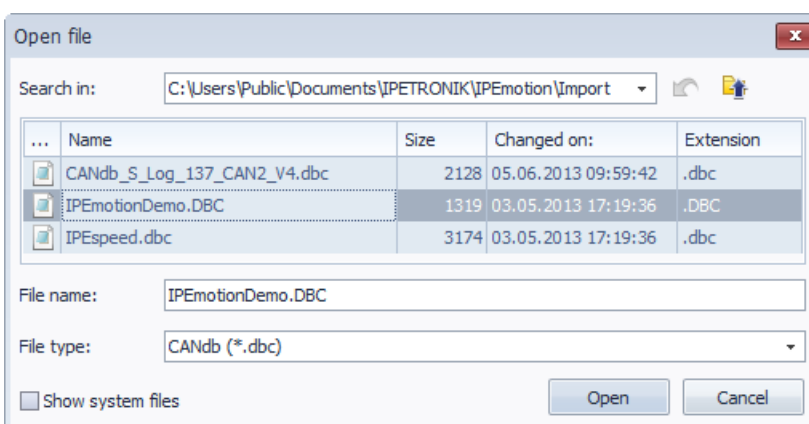
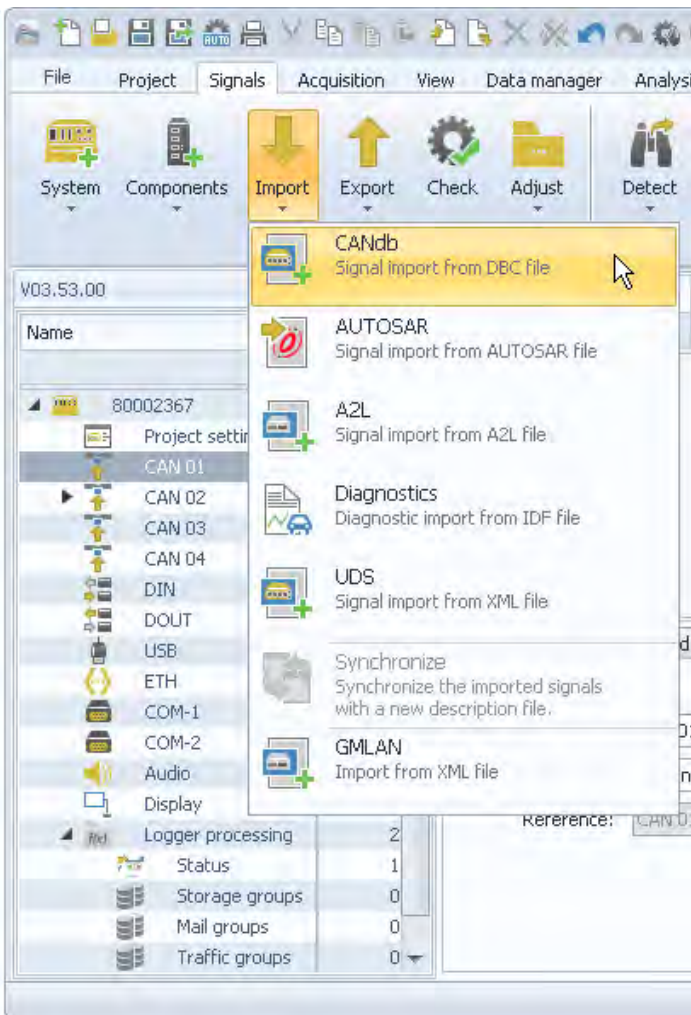

Import signal descriptions from the CANdb

Signals in data source

Select signal

Properties of highlighted signal (Front_right)

Project

Project numbr
Project versic

Protocol: FreeRunning

Protocol FreeRunning
Signal count 10
CAN baudrat 0 Bd
J1939

Message

Name SIM_51499999...
CAN ID a h
Length 8
Sampling rate 1 Hz
Description

Signal

Name	TPS_Volt
Display identi	
Byte order	INTEL
Data type	16-Bit integer u...
Bit count	16
Start bit	48
Bit mask	ffff h
Physical minin	-8
Physical maxi	8
Unit	V
Factor	0,000244144
Offset	-8
CAN ID	a h

Importer

In this dialog, all signals that can be imported from the description file are displayed.
In the left table, all signals, where the "selection" checkboxes are selected, will be marked for import.
In the right table the properties of the selected signals, the control unit and the protocol are displayed.
Depending on the protocol, a sampling rate or the DAQ list to use, can be assigned to the signals. In the case of a protocol using DAQ lists (CCP, XCP), you can specify via the column selection dialog, if the signals are configured by the sampling rate or a DAQ list. To achieve this you should open the column selection dialog, via the context menu of the table header, and then drag the desired column ("sampling" or "DAQ list") from the column selection dialog to the table header. The other column is removed automatically.
If in a protocol based on DAQ lists, sampling rates are used for the signal configuration, during import the signals are assigned to the available DAQ list with the most suitable sampling rate.

Select all

IPEmotionDemo.DBC - 4 of 10 signals selected.

OK

Cancel

Import ASAP file

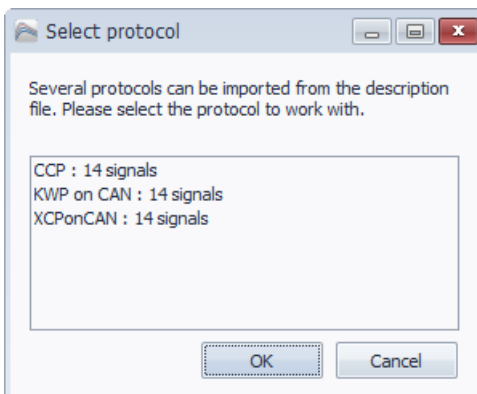
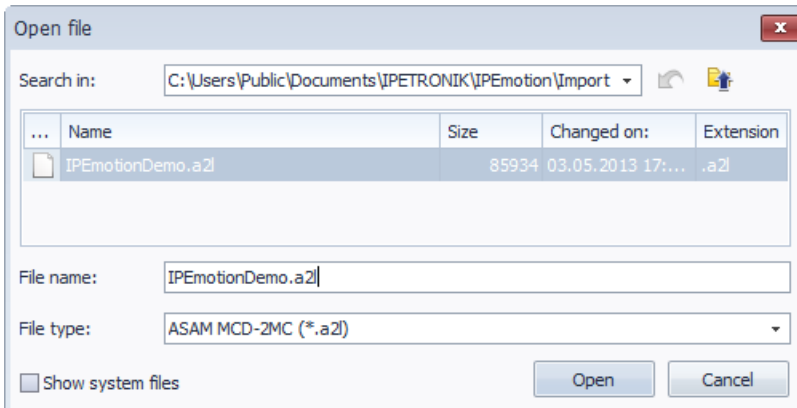
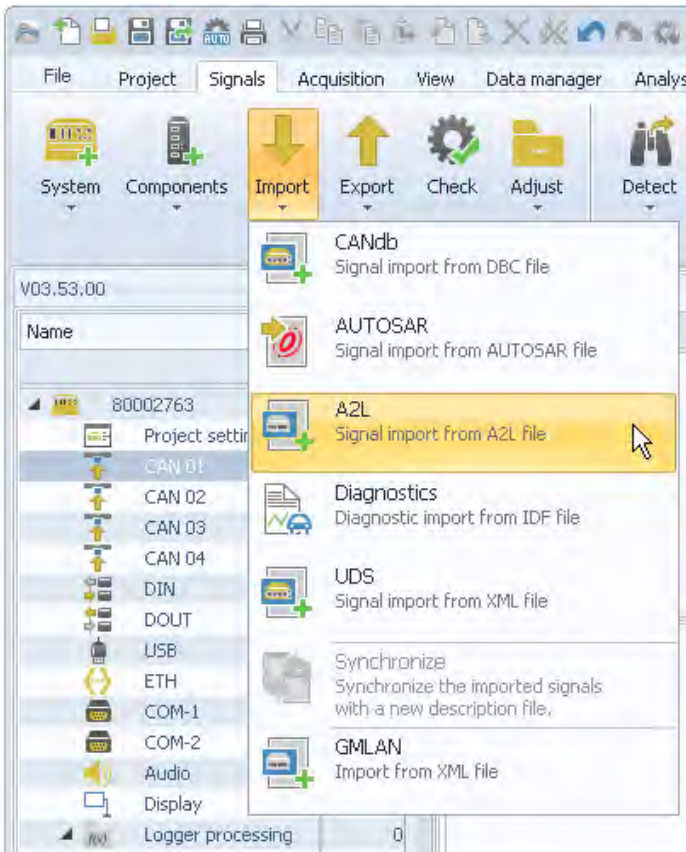

Import signal descriptions from A2L

Signals in data source

Select signal

Properties of highlighted signal (Front_right)

Name	Selection	Sampling rate	Physical range	Description
Voltage_1	<input checked="" type="checkbox"/>	1 Hz	0 V ... 996 mV	Test voltage 1
Voltage_2	<input checked="" type="checkbox"/>	1 Hz	0 V ... 996 mV	Test voltage 2
Voltage_3	<input checked="" type="checkbox"/>	1 Hz	-10 V ... +9,999 V	Test voltage 3
Temp_1	<input checked="" type="checkbox"/>	1 Hz	0 °C ... 255,996 °C	Temp measuring value 1
Temp_2	<input checked="" type="checkbox"/>	1 Hz	-60 °C ... +1370 °C	Temp measuring value 2
Temp_3	<input checked="" type="checkbox"/>	1 Hz	-20 °C ... +107,998 °C	Temp measuring value 3
Meaval_1	<input type="checkbox"/>	1 Hz	0 m/s ² ... 127,5 m/s ²	Sample measuring value 1
Meaval_2	<input type="checkbox"/>	1 Hz	0 m/s ² ... 100 m/s ²	Sample measuring value 2
Meaval_3	<input type="checkbox"/>	1 Hz	0 m/s ² ... 127,5 m/s ²	Sample measuring value 3
Meaval_4	<input type="checkbox"/>	1 Hz	0 m/s ² ... 100 m/s ²	Sample measuring value 4
Meaval_5	<input type="checkbox"/>	1 Hz	0 m/s ² ... 127,5 m/s ²	Sample measuring value 5
U_Batt	<input type="checkbox"/>	1 Hz	0 V ... 25,5 V	Battery voltage
BatTemp	<input type="checkbox"/>	1 Hz	-20 °C ... +107 °C	Battery temp
StrgTemp	<input type="checkbox"/>	1 Hz	-20 °C ... +107 °C	ECU temp

Project

Project number: DEMO010000
 Project version: DEMO010000
 Control unit code: 1

Control unit

Control unit name: IPEmotion Demo
 EPK address: 0 [h]
 ECU version: 1.0

Protocol: CCP

Protocol: CCP
 Version: 2.1
 Signal count: 14
 Seed and key: [empty]
 CAN baudrate: 500 kbd
 Byte order: MOTOROLA...
 Bytes only:
 CRO: 7bc [h]
 DTO: 7bd [h]
 Optional command: 0c0d0e1119...
 Station ID: 12ed [h]

DAQ lists

Polling

DAQ type: Polling

Importer
 In this dialog, all signals that can be imported from the description file are displayed. In the left table, all signals, where the "selection" checkboxes are selected, will be marked for import. In the right table the properties of the selected signals, the control unit and the protocol are displayed. Depending on the protocol, a sampling rate or the DAQ list to use, can be assigned to the signals. In the case of a protocol using DAQ lists (CCP, XCP), you can specify via the column selection dialog, if the signals are configured by the sampling rate or a DAQ list. To achieve this you should open the column selection dialog, via the context menu of the table header, and then drag the desired column ("sampling" or "DAQ list") from the column selection dialog to the table header. The other column is removed automatically.

Select all IPEmotionDemo.a2l - 6 of 14 signals selected. OK Cancel

CCP protocol settings

Resume active
 The ECU can be disconnected and and reconnected to the CAN bus. Data acquisition is continued after reinitialization.

Seed & Key
 Authentication procedure used for restricted access to ECUs. A program file provided by the ECU manufacturer is required to proof access authority.

EPK check
 Compares the checksums of the configuration (A2L file) with the respective sums stored with the ECU.

Use optional commands
 Enables optional commands provided by the ECU. Commands are listed in the A2L file and make the communication more comfortable.



You need to copy the Seed&Key file which relates to the ECU to one of the these subdirectories. If the file is missing the authentication procedure fails.

C:\Users\Public\Documents\IPETRONIK\IPEmotion\Import
C:\Users\Public\Documents\IPETRONIK\IPEmotion\Custom\SeedAndKey

Import PDX file

In order to align the version of the A2L file with the contents stored in the ECU, several PDX files can be imported at a single CAN knot. Each ECU requires its corresponding PDX file.

The PDX file contains all necessary information to request program and data version from the ECU. After the import of this information, the logger reads the corresponding data from the ECU using the UDS protocol. A matching algorithm compares the contents of the relating *.a2l file with the data read from the ECU.

Depending on the result of the comparison, measurement will be resumed, stopped totally or partial, e.g. with protocol measurements with a CAN, FlexRay or Ethernet ECU.

Program an data version information imported from the ECU will be stored in the log file and the measurement status file. Tasks that require a Java script are not implemented.

Supported physical connection are: Diagnostic CAN, OBD2 connector, standard CAN tapping point.

Import properties – DAQ list fill level (numerical, graphical)

Highlight the respective DAQ list (e.g. 100 ms sync event channel) and right click with the mouse to open the context menu, select **Import properties**.

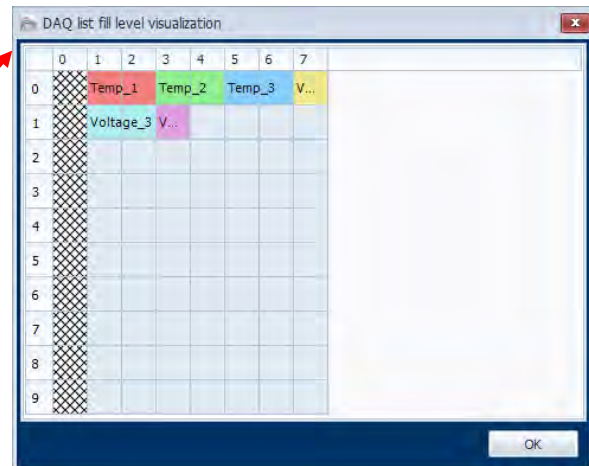
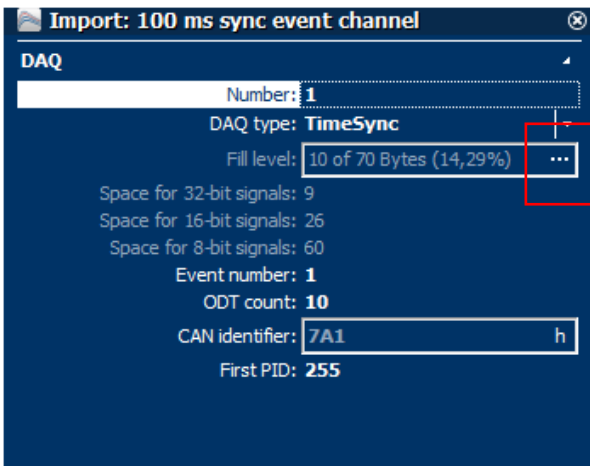

Import Diagnostic file

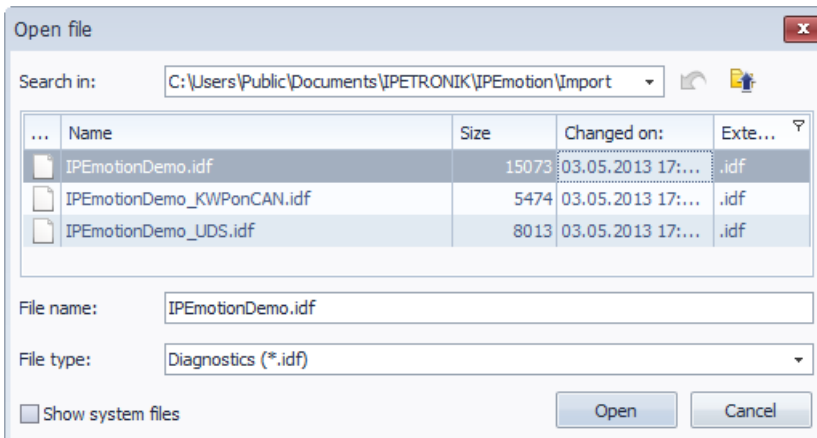
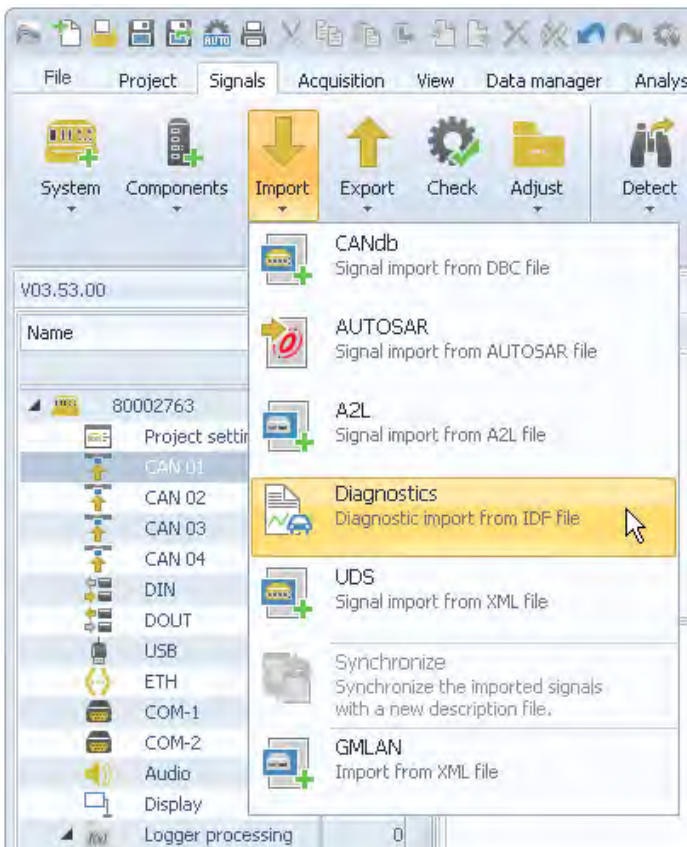

Description file synchronizing

The synchronization feature provides the possibility to compare existing signal descriptions (imported previously) with the respective entries of a modified description file.

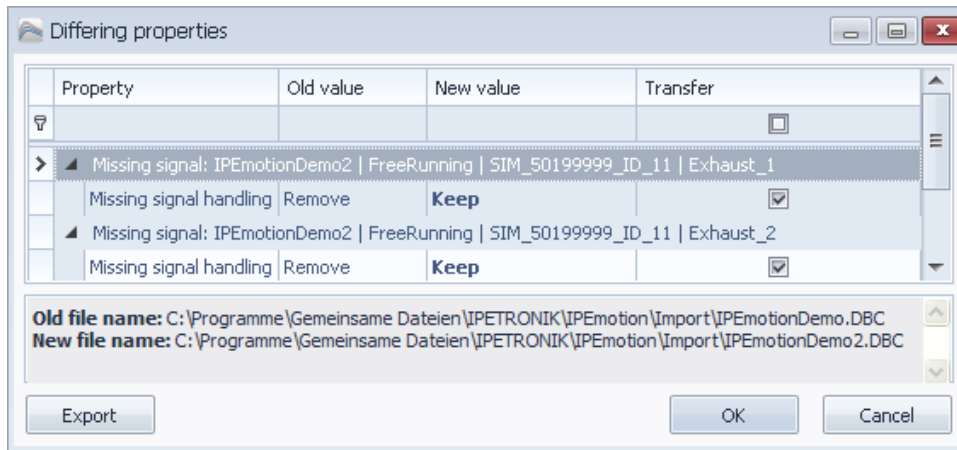

Possibility 1: Channels within a description file have been modified

Previously a description file has been imported and signals have been assigned to the CAN measuring input. Now, a new description file containing modified scaling settings of several signals should be used.

Highlight the description file at the CAN input in the left hand system structure and select **Import > Synchronize** from the main menu or from the context menu. Search for the modified description file on your computer and confirm your selection with **OK**. The new settings will be used for the current configuration.

Possibility 2: Channels have been added to a description file

Previously a description file has been imported and signals have been assigned to the CAN measuring input. Now, a new description file containing additional channel settings (signals have been added) should be used.

Highlight the description file at the CAN input in the left hand system structure and select **Import > Synchronize** from the main menu or from the context menu. Search for the modified description file on your computer and confirm your selection with **OK**. The CAN input will be synchronized with the new settings. Even if you open the import module again, new channels will be displayed in the left hand area. Select the channels to import the related settings into the current configuration.

8.2.2 Detection mode and cycle rate

Polling

Polling functionality is supported by A2L for CCP and XCP, i.e. no DAQ lists are required.

Polling
10 ms sync event channel
100 ms sync event channel
seg sync event channel

IPEmotion offers three different speeds for data requests. The times are reference values because the values must be individually requested at the control unit and create a high bus load.

SLOW 1000 ms MIDDLE 100 ms FAST 10 ms

Example: If 5 values are detected in the SLOW polling mode, the 1st value is requested by the control unit a 2nd time after approx. 6 s.



DAQ list or polling?

Communication via CCP protocol takes place by sending the data cyclically or triggered by an event after the first inquiry. The send rate is defined in the respective DAQ list, e.g. 10 ms, 100 ms or synchronous to an event. Not all control units support this mode or the DAQ lists are not included in the A2L file. In this case, the signals can be sampled individually with the polling mode. But this method causes a much higher bus load and therefore longer response times.

8.2.3 Traffic acquisition

The CAN traffic acquisition (also CAN-Trace) allows high-capacitive recording of CAN and/or LIN messages (total bus traffic) with the CAN/LIN controller of each measuring input. Due to the fact that a huge amount of data can result from this method within a short time, data acquisition can be restricted with definable ID triggers (measuring input) and admission filters (traffic group).

Using the tab **Triggering** a trigger condition can be defined for each traffic group to control data recording individually.

Filters and triggers

The **Traffic id trigger** at the respective CAN input of the system structure provides 6 individual ID triggers. As soon as at least one of the trigger conditions is fulfilled, traffic recording is started (logical OR function). Without any Traffic id trigger, traffic recording is started immediately after measurement start. Each id trigger can consist of a single identifier or an identifier range (First/Last CAN ID). Within the trigger definition, each of 8 bytes from the CAN message can be compared with a reference (supported operators: =, <, >, <=, >=, <>). Only if all conditions defined by the tab ID-Trigger are fulfilled, the respective ID-Trigger becomes active (logical AND function).

Status channels of Traffic id triggers can be used in calculations, e.g. only if a specific id trigger indicates status 1, traffic recording is started. Without any use of the **Traffic trigger status**, activate the checkbox **Trigger direct** under the tab **ID-Trigger** to start the traffic acquisition properly.

Data format and conversion

Traffic data is saved in a binary file with header (description) and the actual data, e.g. TD001234.bin. To generally use the data (e.g. import in CANalyzer), data is converted into the ASCII format with the data converter.

Use the IPETRONIK data converter version 2.xx IPEconverter WIN with graphical user interface (requires a license) or the version with the command line IPEconverter CMD (no license required).

The software, as well as, the documentation are saved at the IPETRONIK CD:

...\IPETRONIK_SoftwareProducts\Tools\DataConverter\...

Configuring traffic acquisition

1. Select a CAN input (CAN 02).
2. Select **Traffic recording** from the main menu **Components** or with the context menu and right mouse button.
3. Now the tree structure shows the new arm **Traffic recording** at the respective CAN input.
4. Select **Filter** and/or **ID-Trigger** from the main menu **Add components** or with the context menu and right mouse button to restrict the recording to the required data.

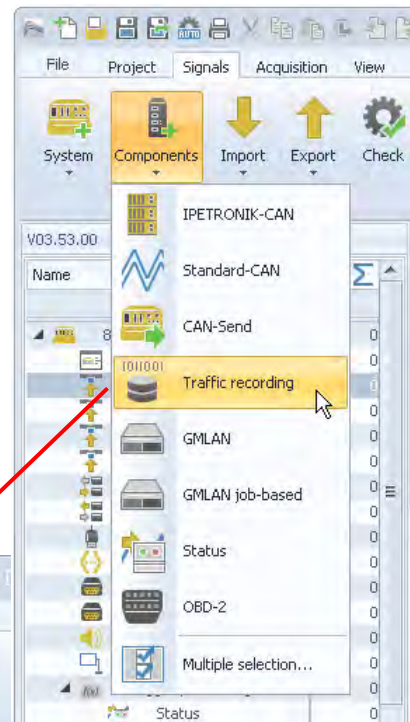

This screenshot shows the main configuration window of the software. The 'Configuration' tab is active. The left sidebar shows a tree structure with 'CAN 01' selected, and 'Traffic recording' and 'Traffic id trigger' are visible under it. The main area displays a table of CAN inputs and their associated filters.

Name	Active	Unit	Phys Min	Phys Max	Sensor Min	Sensor Max
CAN 01 Traffic trigger status 01	<input type="checkbox"/>		0	1	0	1
CAN 01 Traffic trigger status 02	<input type="checkbox"/>		0	1	0	1
CAN 01 Traffic trigger status 03	<input type="checkbox"/>		0	1	0	1
CAN 01 Traffic trigger status 04	<input type="checkbox"/>		0	1	0	1
CAN 01 Traffic trigger status 05	<input type="checkbox"/>		0	1	0	1
CAN 01 Traffic trigger status 06	<input type="checkbox"/>		0	1	0	1

Name	Active	Description	First CAN ID [hex]	Last CAN ID [hex]	Operator for Byte 1	Value for Byte 1 [hex]	Data for Byte
ID-Trigger 01	<input checked="" type="checkbox"/>	ID-Trigger	A	A	Off		0
ID-Trigger 02	<input type="checkbox"/>	ID-Trigger	A	A	Off		0
ID-Trigger 03	<input type="checkbox"/>	ID-Trigger	A	A	Off		0
ID-Trigger 04	<input type="checkbox"/>	ID-Trigger	A	A	Off		0
ID-Trigger 05	<input type="checkbox"/>	ID-Trigger	A	A	Off		0
ID-Trigger 06	<input type="checkbox"/>	ID-Trigger	A	A	Off		0

General ID-Trigger

First CAN ID: A h Last CAN ID: A h

Byte 1: Off 0 d 255 d Byte 5: Off 0 d 255 d

Byte 2: Off 0 d 255 d Byte 6: Off 0 d 255 d

Byte 3: Off 0 d 255 d Byte 7: Off 0 d 255 d

Byte 4: Off 0 d 255 d Byte 8: Off 0 d 255 d

Trigger direct:

Creating a traffic group

1. Use Components to create a Traffic recording. You can add Traffic recording to any free CAN input.
2. Highlight **Traffic groups** from the left hand system structure
3. Select **Traffic group** from the main menu **Components** or with the context menu and right mouse.
4. If needed, create further traffic groups and activate all CAN inputs you want to record traffic data from. You may use traffic data from a single CAN input in different traffic groups but recorded dependent on different triggers.

The screenshot illustrates the software interface for creating and configuring a traffic group. The main window shows a system tree on the left with 'Traffic groups' expanded. A context menu is open over 'Traffic group 01', showing options like 'Ring buffer traffic group' and 'Multiple selection...'. A secondary window shows the configuration for 'Traffic group 01', including a table of CAN inputs and a settings panel.

Name	Active	Description
CAN 01	<input checked="" type="checkbox"/>	Connector to
CAN 02	<input checked="" type="checkbox"/>	Connector to be saved 2
CAN 03	<input type="checkbox"/>	Connector to be saved 3

General Settings

Active:

Name: Traffic group 01

Description: Traffic group on the data logger

Reference: Traffic group 01/80002763

Traffic group and ring buffer traffic group settings

Traffic group

Ring buffer traffic group

General Settings Triggering

Quick start:

Prefix:

External storage:

General Settings Triggering

Quick start:

Prefix:

Ring buffer

Ring buffer size: Duration

Messages

- Quick start** Quick start data (which is recorded during logger boot-up) is identified by a negative time stamp within the traffic data file.
- Prefix** The storage group name ist used for the measurement data file name.
- External storage** Data storage on external USB storage medium. Refer to [6.5 USB medium for external storage](#) for detailed information.
- Ring buffer size** Defines the size of the ring buffer for measuring. If the max ring buffer size is reached, the memory is overwritten beginning with the oldest data.

Triggering

General Settings Triggering

Mode: Start- and Stop-trigger

Pre-trigger: Duration
 Messages

Post-trigger: Duration
 Messages

Start-trigger:

Stop-trigger:

Continuous acquisition

Start-trigger

Stop-trigger

Start- and Stop-trigger

Stop is inverted start

Inactive

- Mode** Select the trigger mode (depending on the traffic group) from:
 Continuous acquisition (no trigger), Stop is inverted start
 Traffic group only:
 Start-trigger, Stop-trigger, Start- and Stop-trigger (see [Triggering](#))
- Pre-trigger duration** Data recorded before the trigger event (duration = seconds or messages)
- Post-trigger duration** Data recorded after the trigger event (duration = seconds or messages)
- Start-trigger** Value, which starts the data storage of the respective group.
- Stop-trigger** Value, which stops the data storage of the respective group.



Using the Start-Stop condition, storage data will not be saved if the stop condition is already fulfilled at measurement start!

We recommend to define suitable events used for start- and stop-trigger. To guarantee acquisition start (data storage) in any case, you can set „1“ as start-trigger condition.



To evaluate quick start data in relation to cyclic data of a storage group, you have to activate **Time stamp channel** (for the absolute time) from the settings tab of the respective storage group.

Filtering

User definable pass through filters enable the filtering of defined areas out of the data stream. This provides an ID filtering like: Traffic group 01 using ID 100[hex] while Traffic group 02 uses other filters or no filters.

Name	Active	Description	First CAN ID [hex]	Last CAN ID [hex]
> Filter 01	<input checked="" type="checkbox"/>	Admission filter for reducing the data volume	0	7F
Filter 02	<input checked="" type="checkbox"/>	Admission filter for reducing the data volume	0	7F
Filter 03	<input type="checkbox"/>	Admission filter for reducing the data volume	0	7F
Filter 04	<input type="checkbox"/>	Admission filter for reducing the data volume	0	7F
Filter 05	<input type="checkbox"/>	Admission filter for reducing the data volume	0	7F
Filter 06	<input type="checkbox"/>	Admission filter for reducing the data volume	0	7F
Filter 07	<input type="checkbox"/>	Admission filter for reducing the data volume	0	7F
Filter 08	<input type="checkbox"/>	Admission filter for reducing the data volume	0	7F
Filter 09	<input type="checkbox"/>	Admission filter for reducing the data volume	0	7F
Filter 10	<input type="checkbox"/>	Admission filter for reducing the data volume	0	7F
Filter 11	<input type="checkbox"/>	Admission filter for reducing the data volume	0	7F

General Filter

First CAN ID:

Last CAN ID:

8.2.4 Statistics calculation

The frequency of signals is counted and evaluated with classifications. To do so, the acquisition range is divided into equal (equidistant) zones (classes). The current values is assigned to one class at every sampling and the frequency is counted (see figure).

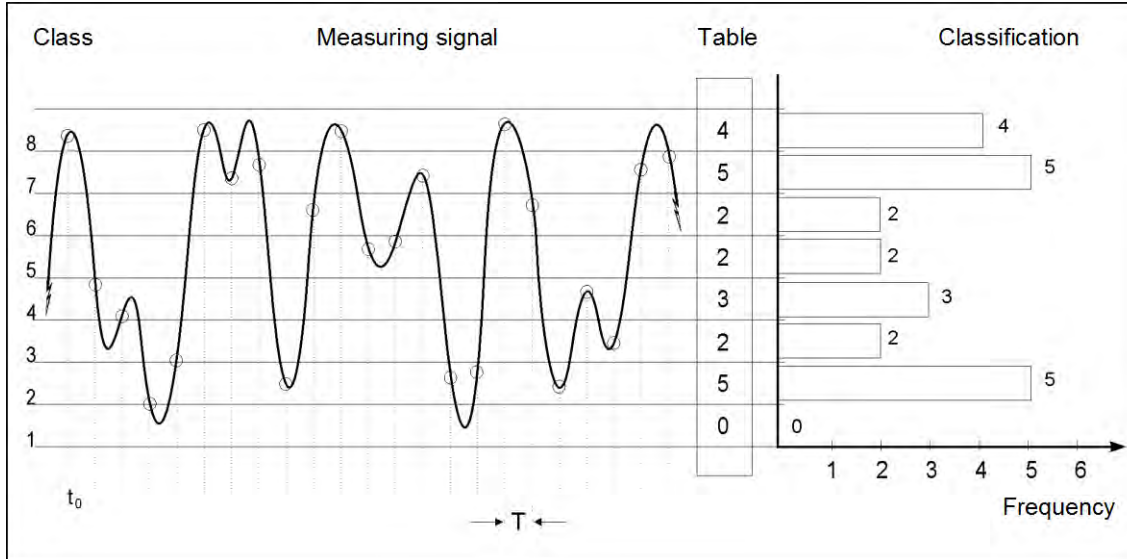

Advantages	Disadvantages
Much less storage required than with a time related acquisition	No original value
Very suitable for statistical analyses (e.g. life cycle tests)	No time reference of the signal

Classification methods

Different classification methods have been developed in the past whereof IPETRONIK supports the most common methods (acc. to DIN 45667, FVA sheet):

- ▶ Random sampling counting
- ▶ Level crossing counting
- ▶ From-To counting
- ▶ Edge counting
- ▶ Rainflow method (available upon request)

Please find further information in the Classification.pdf document (Classifying with KIM/KAR and DIS) on the IPETRONIK CD or at the FTP info server.

Requirements

Hardware M-LOG, S-LOG, FLEETlog, IPElog

Configuration IPEmotion

Software TESTdrive V03.06 or V03.18 (IPEmotion) or V03.50 (IPElog) or higher



It is recommended to use the latest software version for guaranteeing a clean functionality of all components..

Configuring statistic / classification

1st Step Creating configuration

- ▶ Start IPEmotion and load an existing configuration or create a new configuration.
- ▶ Import the corresponding signal descriptions (CANdb or ASAP2) and/or configure additional IPETRONIK devices.
- ▶ Activate the desired inputs and run the required scaling.
- ▶ Select a sampling rate or accept the default sampling rate. Please note that the sampling rate, which is selectable in the classification, cannot be higher than the maximum sampling rate.

2nd Step Defining storage group (if time related data is also required)

- ▶ Create a new storage group with **Storage groups** and the context menu **Add components** to also record the time related signals.
- ▶ Assign the desired signals to the corresponding storage group.

3rd Step Defining classification

- ▶ Select **Data processing** in the system structure and select **Statistic** from the main menu **Add components** or with right mouse button > context menu.
- ▶ Select **Statistic** in the system structure and select **Components > Channel** from the main menu or with right mouse button > context menu to create channels.
- ▶ Define additional classification settings within the tabs **General**, **Settings**, and **Trigger**.

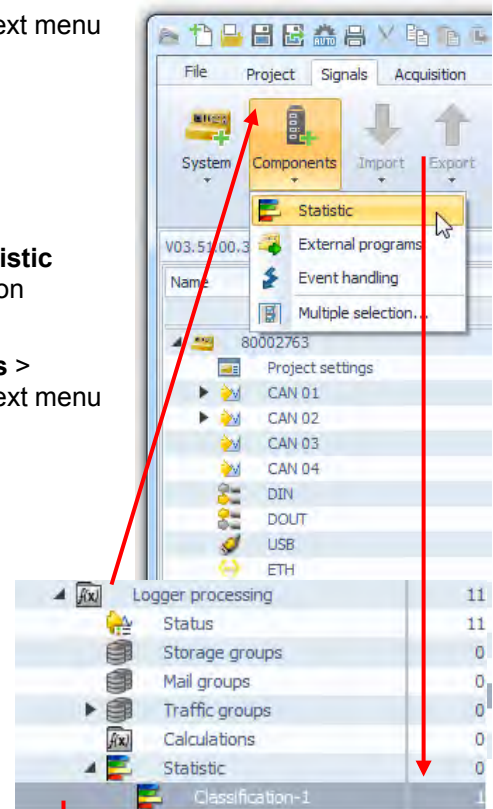

Reset behaviour Data is written into a new classification file at changing the configuration or at starting acquisition.

Sampling rate Data storage rate of classification

Trigger (Statistik) General trigger, defines start- and stop-trigger, value range 0 / 1

Classification

- Name** any name for classification
- Mode** selected classification method
- Trigger** defines start- and stop-trigger of the active channel (classification start and stop)

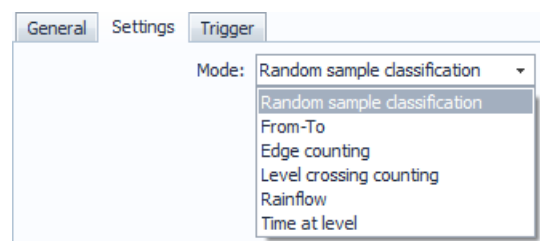

8.2.5 Operating in FTP mode (terminal server)

TESTdrive version 3.09.00 allows starting M-LOG as FTP server. Data can easily be transmitted with a FTP software (e.g. Total Commander or WS_FTP). Depending on the user rights, data can additionally be deleted or written. A separate USB flash drive incl. TESTdriveCmd.xml file is required for this functionality. The running acquisition is stopped and the log file saved with connecting the USB.

If the TESTdriveCmd.xml file includes the "StartFTPServer" OnConnect job, there is no post processing. TESTdrive reads the corresponding parameters and starts the FTP server.

Server access requires the following user data:

Version	User	Password	Access rights
V03.09.00	guest	none	Read to TO directory

A reboot is automatically running at connecting USB flash drive to correctly stop the service as FTP server.

Procedure:

1. Switch-on M-LOG
2. Connect USB flash drive with TESTdriveCmd.xml
3. Connect Ethernet cable between M-LOG and PC, e.g. 600-591.xxx (M-LOG PR05, S-LOG)
4. Configure network settings of PC, create additional "Alternative configuration"

User defined

IP address: 192.168.0.1 (Example)

Total Commander settings: Server name: 192.168.0.2, Enter user name and password

8.2.6 Recording audio and video data

Recording video data

Data logger supports recording video or single shots with a camera. The camera is connected to the logger USB port.

Following settings are available:

Resolution	Defines the image quality	
"Low"	160 x 120 Pixel (B x H)	30/20/10/5 images per second
"Standard"	320 x 240 Pixel (B x H)	30/20/10/5 images per second
"High"	432 x 240 Pixel (B x H)	30/20/10/5 images per second
"Ultra"	640 x 480 Pixel (B x H)	30/20/10/5 images per second

Max. recording time Defines the recording duration

Frame rate Defines the number of images per second

All three options directly influence the required memory.

Trigger	A trigger condition must be defined to start recording.
Trigger mode	Triggering to raw data or scaled values
Raw	Triggering to raw data
Phys.	Triggering to physical values (acc. to scaling)

Recording audio data

Data logger (M-LOG, S-LOG) supports recording audio signals (sounds, speech) with a microphone at the audio input.

Following settings are available:

Bit rate Defines the audio signal quality
22050 Bit/s (FM radio), 11025 Bit/s (AM radio), 8000 Bit/s (Phone quality)

Max. recording time Defines the recording duration

Both options directly influence the required memory.

Trigger A trigger condition must be defined to start recording.

Trigger mode Triggering to raw data (Raw) or scaled values (Phys)

8.2.7 OBD-2 measurement

With releases of the PlugIn IPETRONIK-LOG / TESTdrive \geq V03.22 data acquisition using the OBD2 standard (CAN bus) supported.

The OBD-II international standard details a list of 96 predefined signals and measurement parameters which makes it easy to acquire provided operating data by a data acquisition system. This standard is mandatory for petrol engine cars since 2001 respective diesel engine cars since 2003 and trucks since 2005.

The screenshot displays the IPETRONIK-LOG software interface. The main window shows a configuration panel on the left with a tree view of components. The 'Components' menu is open, showing a list of options including 'OBD-2'. The 'OBD-2' option is highlighted, and a 'Multiple selection...' dialog box is visible. Below the configuration panel, a table lists predefined OBD-2 signals. The table has columns for Name, Active, Unit, Phys Min, Phys Max, Sensor Min, Sensor Max, and Sampling rate. The '001 - Fuel system monitoring supported' signal is selected, and its details are shown in the 'Details' panel below the table.

Name	Active	Unit	Phys Min	Phys Max	Sensor Min	Sensor Max	Sampling rate
OBD processing	<input type="checkbox"/>		0	1	0	1	10 Hz
001 - Number of emission-related DTCs	<input type="checkbox"/>		0	127	0	127	10 Hz
001 - Malfunction Indicator Lamp (MIL) ...	<input type="checkbox"/>		0	1	0	1	10 Hz
001 - Misfire monitoring supported	<input type="checkbox"/>		0	1	0	1	10 Hz
> 001 - Fuel system monitoring supported	<input type="checkbox"/>		0	1	0	1	10 Hz
001 - Comprehensive component monit...	<input type="checkbox"/>		0	1	0	1	10 Hz
001 - Compression ignition monitoring s...	<input type="checkbox"/>		0	1	0	1	10 Hz
001 - Misfire monitoring ready	<input type="checkbox"/>		0	1	0	1	10 Hz
001 - Fuel system monitoring ready	<input type="checkbox"/>		0	1	0	1	10 Hz
001 - Comprehensive component monit...	<input type="checkbox"/>		0	1	0	1	10 Hz
002 - DTC that caused required freeze ...	<input type="checkbox"/>		0	65535	0	65535	10 Hz

Details for '001 - Fuel system monitoring supported':

Active:

Name: 001 - Fuel system monitoring supported

Description: Fuel system monitoring supported

Reference: 001 - Fuel system monitoring supported[1]//OBD-2/80002367

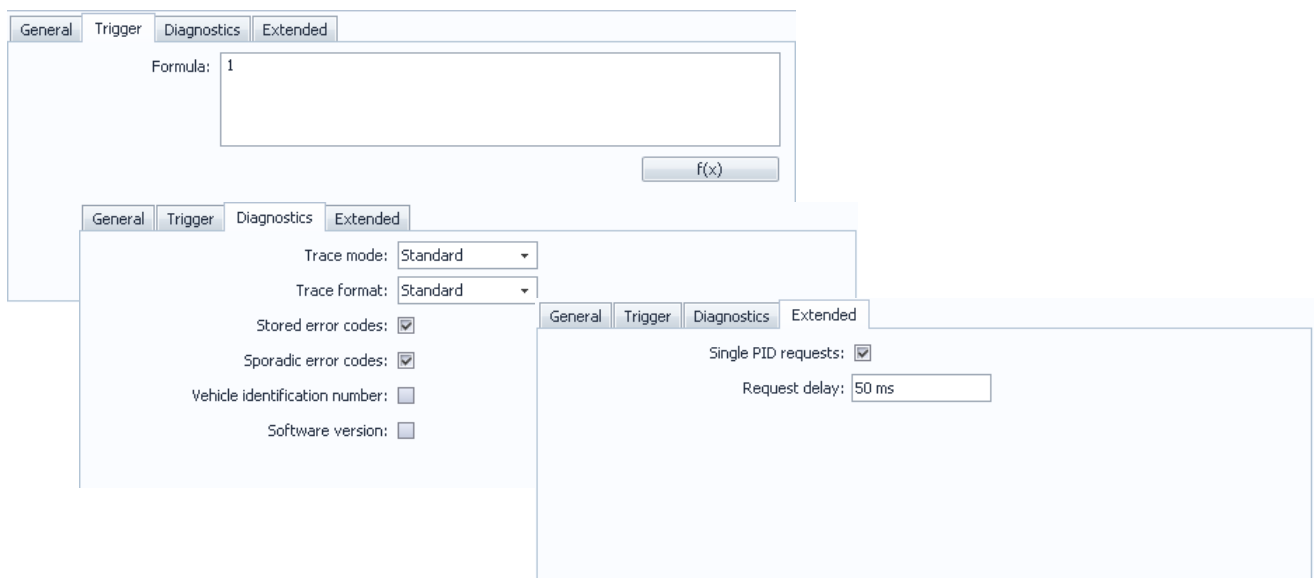
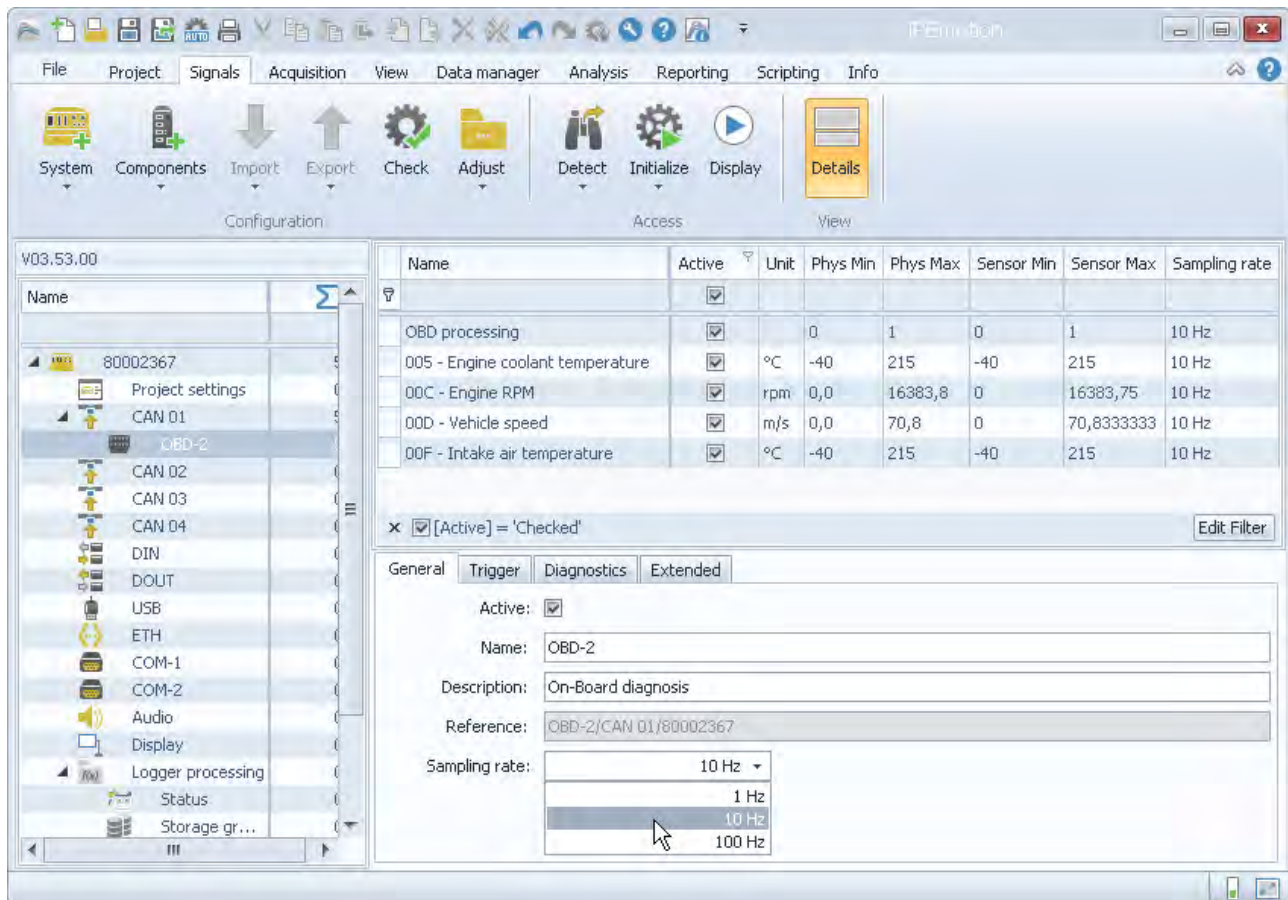

OBD-2 Extensions (TESTdrive V03.52)

- ▶ Selectable data rate 1/ 10/ 100 Hz (depends on the ECU)
- ▶ Measurement start by trigger event
- ▶ Support of Extended IDs (29 Bit)
- ▶ PID single request support (each request to the ECU with a PID)
- ▶ Request delay (delay time between data receipt and sending the following request)

8.2.8 UDS protocol (Unified Diagnostic Services)

UDS protocol combines KWP2000, GMLAN, and DiagnosticOnCan in one protocol. An advantage is the clear session handling (higher compatibility of different control units). Furthermore, UDS supports modern memory structures, which require a > 32 Bit addressing.

The corresponding description file has the ODX extension.

Control units of some manufacturers already support UDS, which will be used as standard diagnostic in near future.

Jobs overview

TESTdrive V03.15 supports the following jobs, which can be read via UDS:

- ▶ FS_READ
- ▶ FS_READ_DETAIL
- ▶ IDENT
- ▶ READ_DATA_REFERENCE
- ▶ FG_READ
- ▶ DYNAMICALLY_DEFINE_LOCAL_ID

These jobs can be defined with an *.idf file.

Storing data

The results are optionally stored as binary file (*.CSV and *.J**) or as trace and binary file (*.CSV, *.J** and *.T**).

The files are identified as follows:

Single data detected via KWPOnCAN: (former description)	BDKxxxx.CSV bzw. BDKxxxx.Jxx BDJxxxx.CSV bzw. BDSxxxx.Jxx
UDS data detected via trace mode:	BDUxxxx.txx

Selecting protocol

The UDS protocol is selected with the corresponding tab in the import module.



*Read more details on the UDS protocol and relating applications from this document:
Manual ECU Diagnostics.pdf*

8.3 Recording GPS-Data

The GPS receiver GPS 18 and the NMEA protocol option, M-LOG, S-LOG, as well as, FLEETlog WAN with integrated GPS receiver support the continuous recording of GPS data with the global satellite navigation system. This functionality allows positioning and logging of test routes with a data rate of 1 Hz.

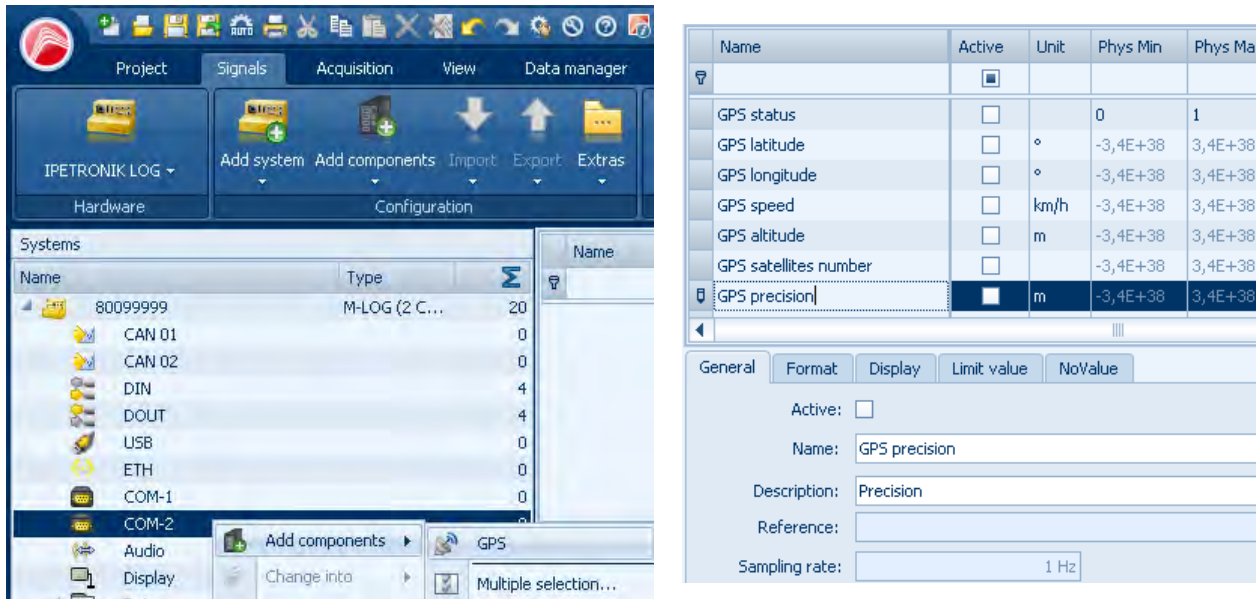

Name	Active	Unit	Phys Min	Phys Ma
GPS status	<input type="checkbox"/>		0	1
GPS latitude	<input type="checkbox"/>	°	-3,4E+38	3,4E+38
GPS longitude	<input type="checkbox"/>	°	-3,4E+38	3,4E+38
GPS speed	<input type="checkbox"/>	km/h	-3,4E+38	3,4E+38
GPS altitude	<input type="checkbox"/>	m	-3,4E+38	3,4E+38
GPS satellites number	<input type="checkbox"/>		-3,4E+38	3,4E+38
GPS precision	<input checked="" type="checkbox"/>	m	-3,4E+38	3,4E+38

General | Format | Display | Limit value | NoValue

Active:

Name: GPS precision

Description: Precision

Reference:

Sampling rate: 1 Hz

Predefined settings are available to configure the acquisition. The single channels are activated as required.



The accuracy of the positioning data is considerably defined by the number of received satellites (12 satellites are in the geostationary orbit).

Due to physics, the accuracy of the height acquisition (Altitude) with this method is considerably lower than that of the length acquisition (Latitude = geographical width, Longitude = geographical length).



Different altitude signals with FLEETlog STD and FLEETlog WAN.

Depending on the GPS hardware of FLEETlog, the logger acquires altitudes which may differ from the reference height (geographic NHN). This behaviour is caused by the use of the "ellipsoidal height" for the height reference.

Please execute a calibration measurement on a height which is known exactly to verify GPS data of your logger system.

8.4 Remote data transfer

The logger offers the availability of wireless data transfer by corresponding options. Single vehicles, as well as, entire vehicle fleets can be managed from one or several bases. Due to the worldwide good to excellent GSM network coverage, regional and global test drives can be managed from any base.

8.4.1 Transferring data using GPRS and Internet to FTP server

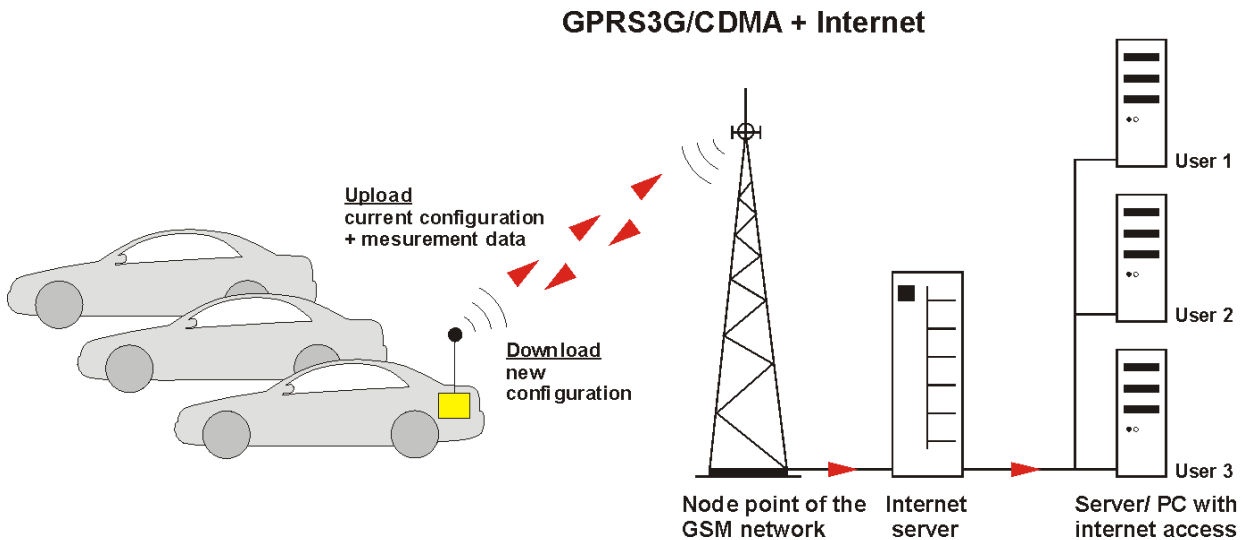

Components

- ▶ M-LOG/M-LOG V3, S-LOG, FLEETlog2, IPElog/IPElog2
- ▶ M-LOG, S-LOG with GPRS data transfer option with COMgate WAN, antenna, data transfer software or with modem, antenna, data transfer software
- ▶ Connecting cables
- ▶ SIM card for modem (depending on provider)

Functional principle

A logger in measuring mode continuously stores data as defined in the configuration. If the test series is completed (status of remote signal is inactive, e.g. terminal 15), data is packed and transferred via GPRS in GSM network to the next node point. This data is then transferred via internet to a FTP server for being available for download. All data transfer settings are defined in the IPETRONIK software.

8.4.2 Transferring data using Wireless LAN to network server

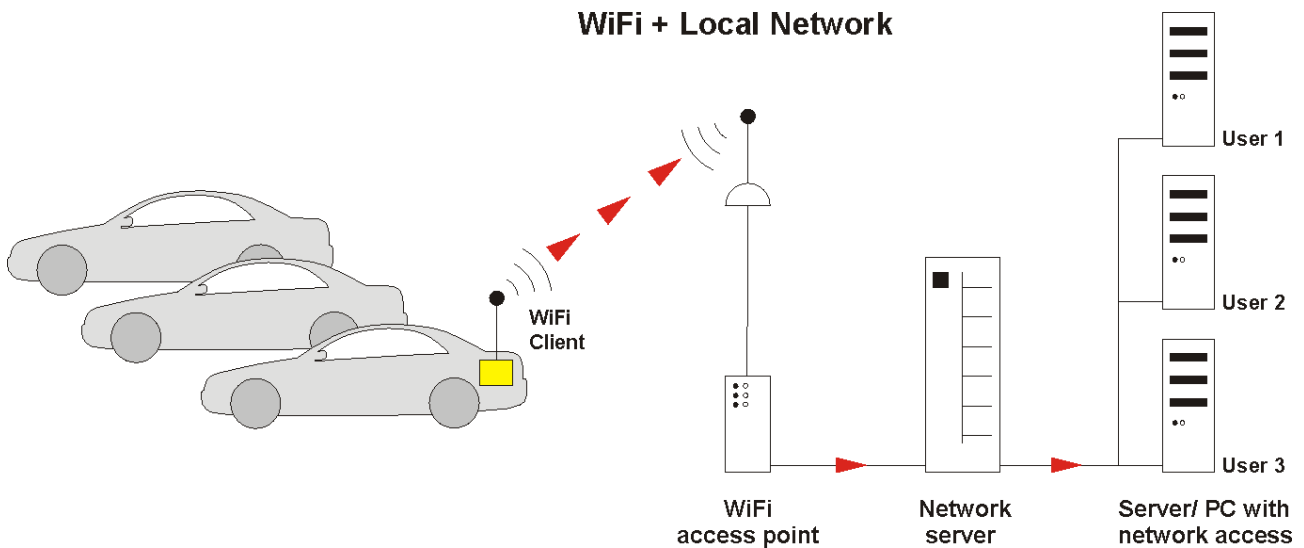

Components

- ▶ M-LOG/M-LOG V3, S-LOG, FLEETlog2, IPElog/IPElog2
- ▶ M-LOG, S-LOG with WiFi data transfer option with COMgate, antenna, data transfer software or with client, antenna, WiFi software
- ▶ Connecting cables
- ▶ WiFi access point to connect with network (M-LOG, S-LOG)

Funktional principle

A logger in measuring mode continuously stores data as defined in the configuration. If the test series is completed (status of remote signal is inactive, e.g. terminal 15), data is packed. If the vehicle is within reach of an access point (up to 300 m outdoors), data is transferred via WiFi to the access point. This data is then transferred via local network to a server. If the local network is connected to the internet, data can also be transferred to a FTP server for being available for download. All data transfer settings are defined in the IPETRONIK software. Due to multiple encoding options (transmission protocol and user), a very high degree of security against unauthorized access is guaranteed.

8.4.3 Data transfer configuration

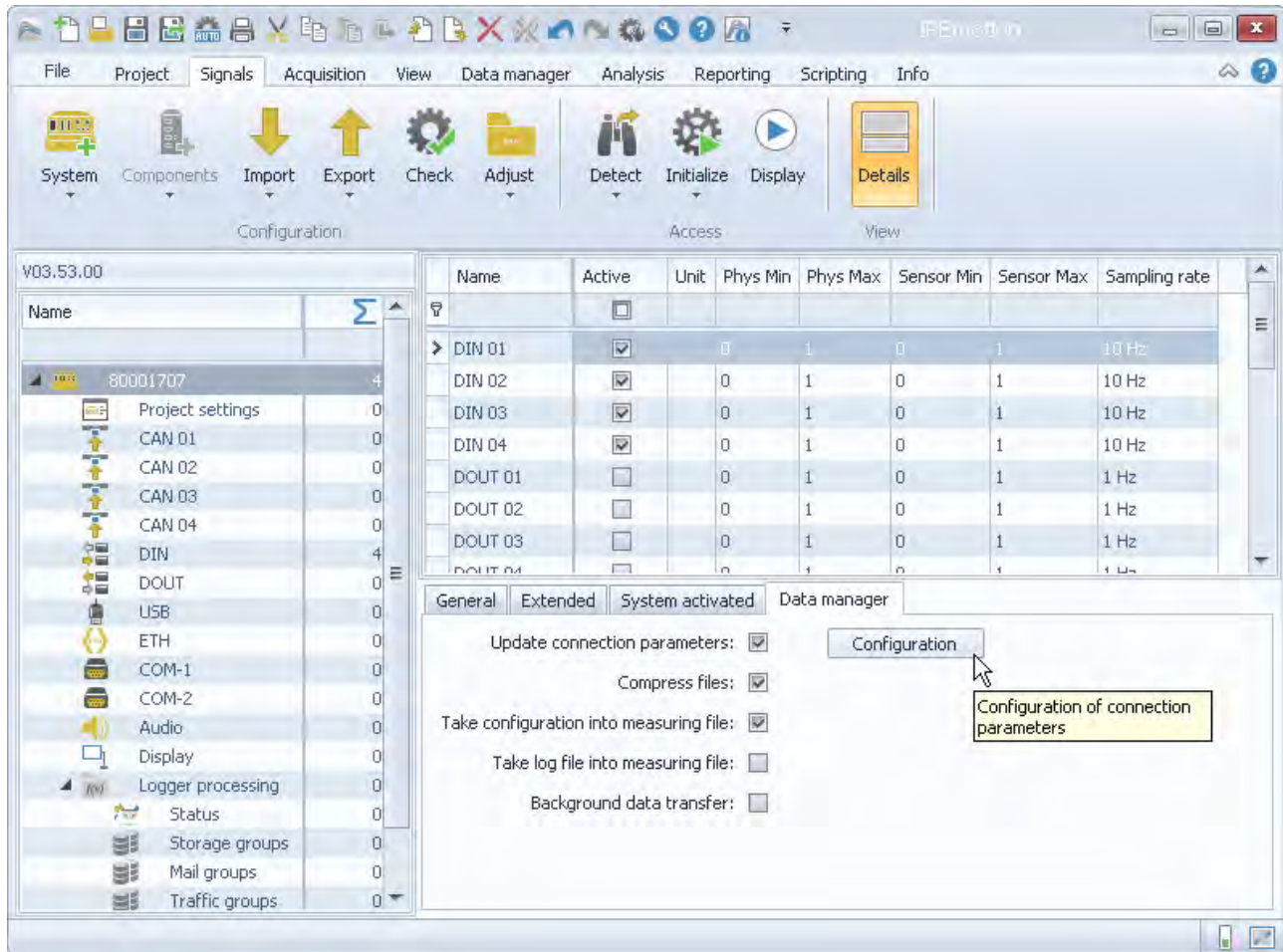

The screenshot shows the IPEmotion software interface. The 'Data manager' tab is active, and the 'Configuration' button is highlighted with a tooltip that reads "Configuration of connection parameters".

Name	Active	Unit	Phys Min	Phys Max	Sensor Min	Sensor Max	Sampling rate
DIN 01	<input checked="" type="checkbox"/>	0	1	0	1	10 Hz	
DIN 02	<input checked="" type="checkbox"/>	0	1	0	1	10 Hz	
DIN 03	<input checked="" type="checkbox"/>	0	1	0	1	10 Hz	
DIN 04	<input checked="" type="checkbox"/>	0	1	0	1	10 Hz	
DOUT 01	<input type="checkbox"/>	0	1	0	1	1 Hz	
DOUT 02	<input type="checkbox"/>	0	1	0	1	1 Hz	
DOUT 03	<input type="checkbox"/>	0	1	0	1	1 Hz	
DOUT 04	<input type="checkbox"/>	0	1	0	1	1 Hz	

Configuration options in the Data manager tab:

- Update connection parameters:
- Compress files:
- Take configuration into measuring file:
- Take log file into measuring file:
- Background data transfer:



Activate **Update connection parameters** to enter the data transfer settings using the **Configuration** button.

To ensure an accurate data transfer after TESTdrive update to 3.52.01 or higher, you have to click this check box also, even if no modification has been made. (The current settings will be transferred to the logger in any case.)

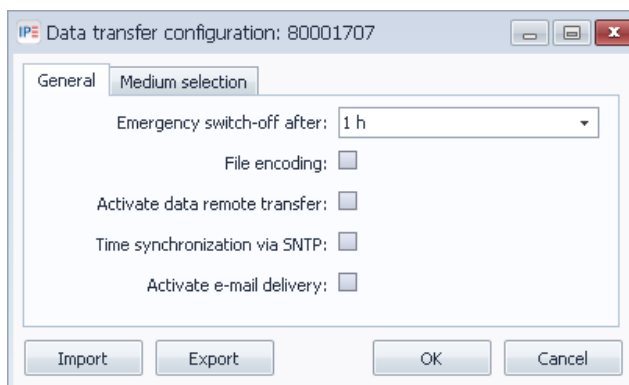

IPe Data transfer configuration: 80001707

General Medium selection

Emergency switch-off after: 1 h

File encoding:

Activate data remote transfer:

Time synchronization via SNTP:

Activate e-mail delivery:

Import Export OK Cancel

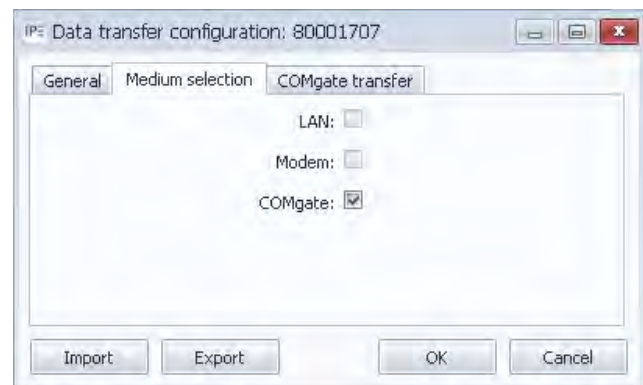

IPe Data transfer configuration: 80001707

General Medium selection COMgate transfer

LAN:

Modem:

COMgate:

Import Export OK Cancel

8.5 Configuring COMgate

COMgate transfer

Modem (3G/HSPA/UMTS)

Data transfer by internal modem (COMgate WAN only).

Wireless LAN (WiFi)

Data transfer by internal WiFi client.

Access Point (AP)

COMgate operates as WiFi access point.

Hotspot

Hotspot (public WiFi access point, e.g. T-Mobile for Germany) to connect the internet.
(Only with Wireless LAN activated!)

Cisco VPN

Encrypted data transfer through VPN tunnel.

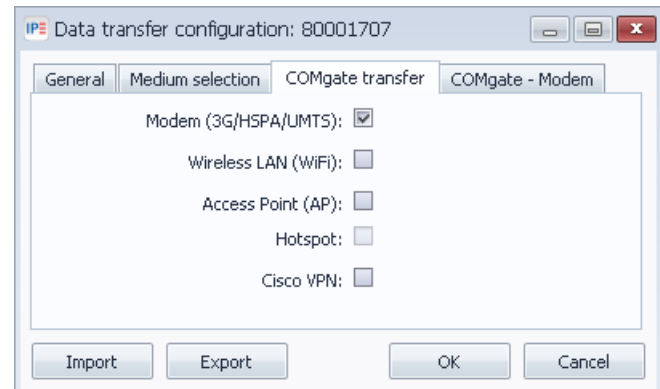

COMgate - Modem

Predefined provider

Select a predefined provider from the drop down list (use of provided standard settings).

Provider: T-Online, Vodafone, O2, E-Plus

PIN code

Identification number of the SIM card

Authentication

Access authorisation by **User name** and **Password**.

Access point (APN)

Name of the access point for the modem connection (APN = Access Point-Name).

Data roaming off

Data transfer enabled only for the defined provider (radio network availability provided)

Provider (MCC+MNC)

Mobile Country Code and **Mobile Network Code** are required identification numbers for manually setting of the radio network provider.

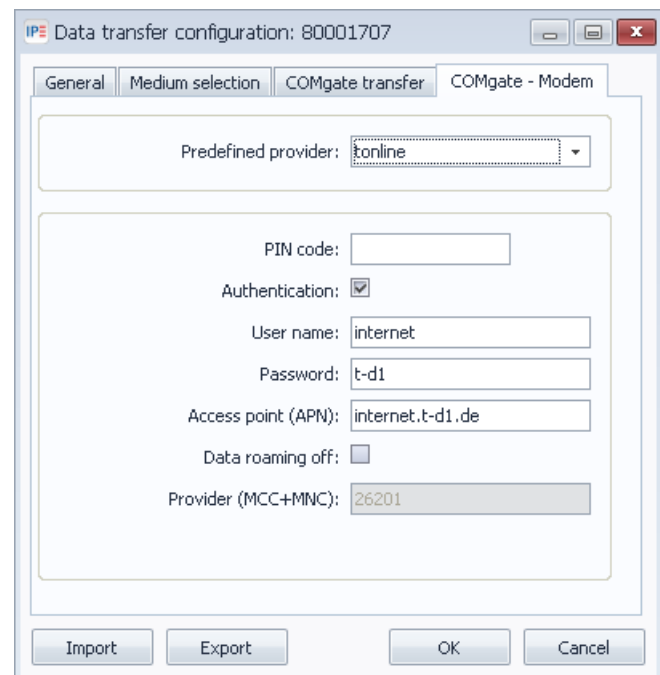

COMgate transfer**Modem (3G/HSPA/UMTS)**

Data transfer by internal modem (COMgate WAN only).

Wireless LAN (WiFi)

Data transfer by internal WiFi client.

Access Point (AP)

COMgate operates as WiFi access point.

Hotspot

Hotspot (public WiFi access point, e.g. T-Mobile for Germany) to connect the internet.
(Only with Wireless LAN activated!)

Cisco VPN

Encrypted data transfer through VPN tunnel.

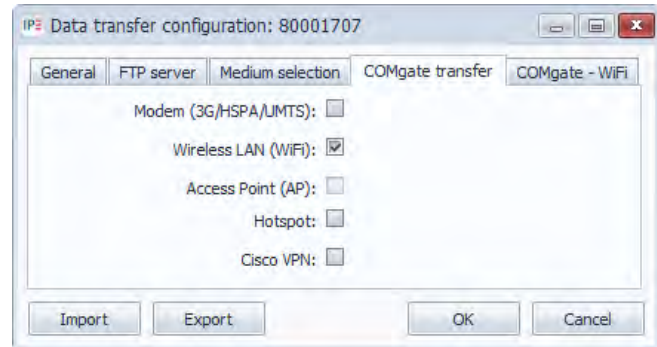
**COMgate - WiFi****SSID**

Net work name of the related access point
(Service Set Identifier)

Security

WiFi transfer protocol WPA, WPA2,
Radius, MSCHAPV2

Password

Password for user access.

User identification

User name for user access.

Certificate

File providing the certificate for the respective
network connection.

DHCP

Automatic handling of IP addresses (IP assignment)
in the network by a server supporting DHCP.

IP address

Manually assigned client IP address

Sub net mask

IP address range of the sub network

Standard gateway

Network address of the standard gateway

Preferred DNS server

Address of the 1st name server (DNS =
Domain Name System) to link the host name, in case
that only the name of the target server has been
entered.

Alternative DNS server

Address of the 2nd name server as fall back, in case
the 1st DNS server is not available.

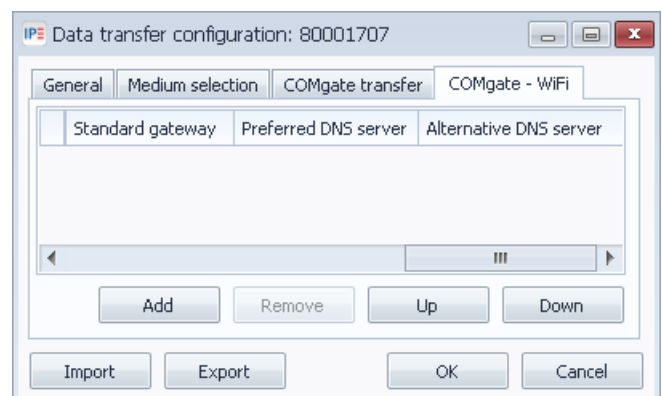
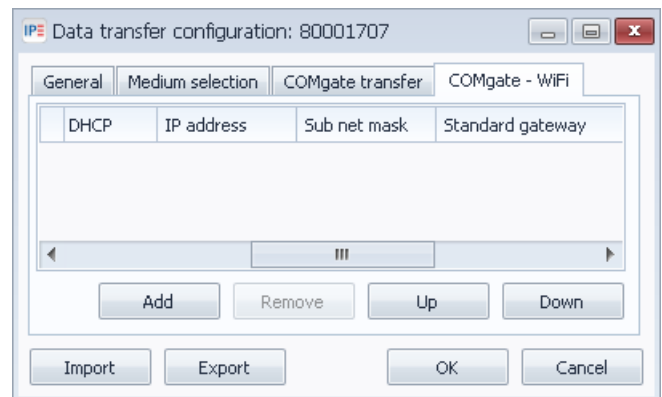
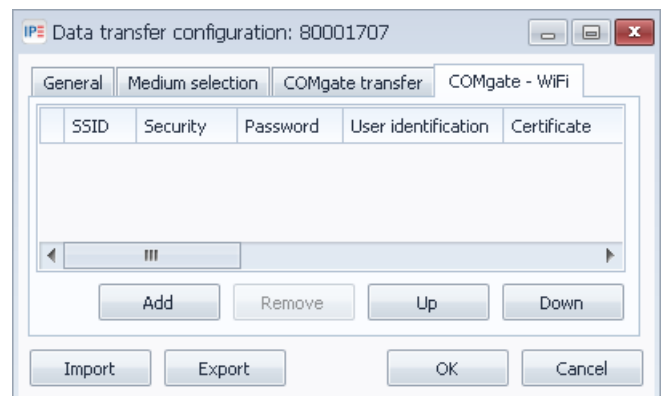

COMgate transfer**Modem (3G/HSPA/UMTS)**

Data transfer by internal modem (COMgate WAN only).

Wireless LAN (WiFi)

Data transfer by internal WiFi client.

Access Point (AP)

COMgate operates as WiFi access point.

Hotspot

Hotspot (public WiFi access point, e.g. T-Mobile for Germany) to connect the internet.

(Only with Wireless LAN activated!)

Cisco VPN

Encrypted data transfer through VPN tunnel.

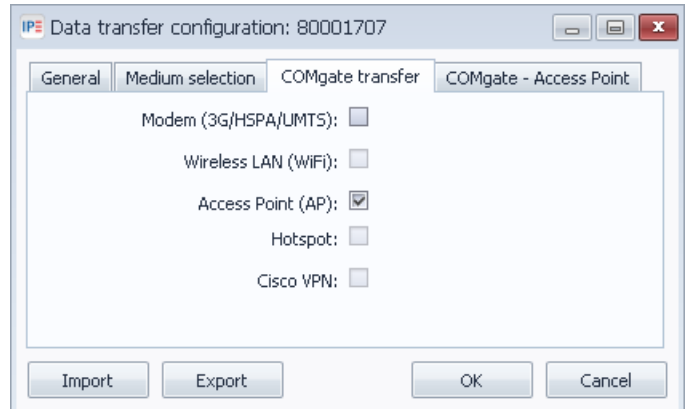
**COMgate - Access Point****SSID**

Net work name of the related access point (Service Set Identifier)

Password

Net work password

IP address

COMgate IP address

Sub net mask

IP address range of the sub network

WiFi channel

Selection of the WiFi channel and the associated carrier frequency.

Activate DHCP server

COMgate acts as host with automatic IP address assignment for the clients.

First available IP address

Lower bound of the IP range, e.g. 198.164.0.101

Last available IP address

Upper bound of the IP range, e.g. 198.164.0.110

Security

WiFi transfer protocol WPA2

Encoding

Security protocol (Temporal Key Integrity Protocol)

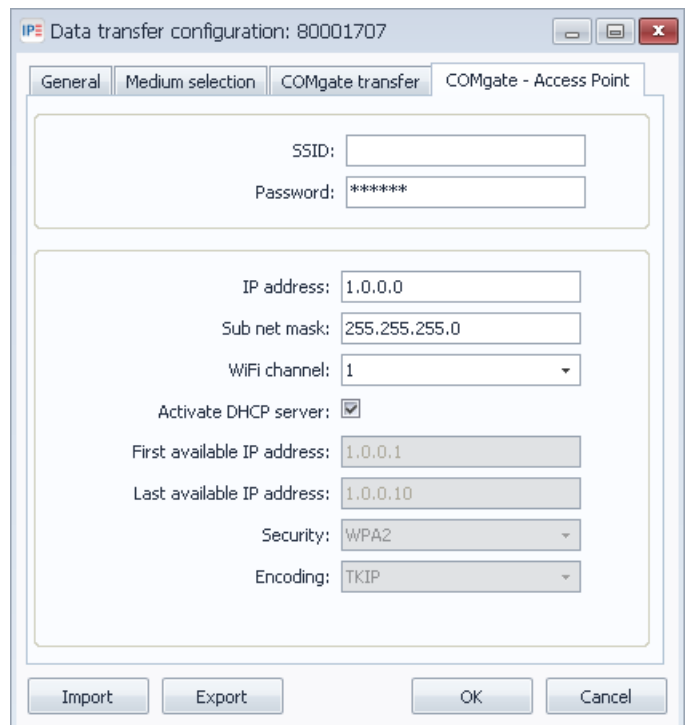

COMgate also provides XCP data transfer from the logger system to a mobile device (with Android operating system) by a WiFi connection. Please read more details regarding to the online data visualization (using XCP service) with the IPEmotion App in this manual:

IPEmotion-App-V02.xx.pdf

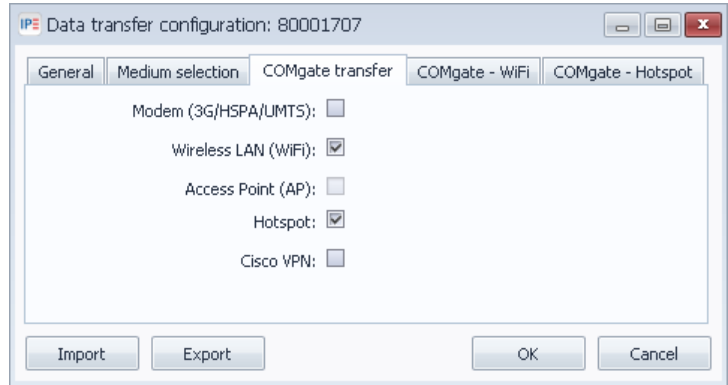

COMgate - Hotspot

Predefined provider

Select a predefined provider from the drop down (use of provided standard settings).

Provider: T-Online

Provider

Name of the provider (entered manually)

User name

User name to access the account.

Password

Pass word to access the account.

LoginCommand

Login command to to access the account.

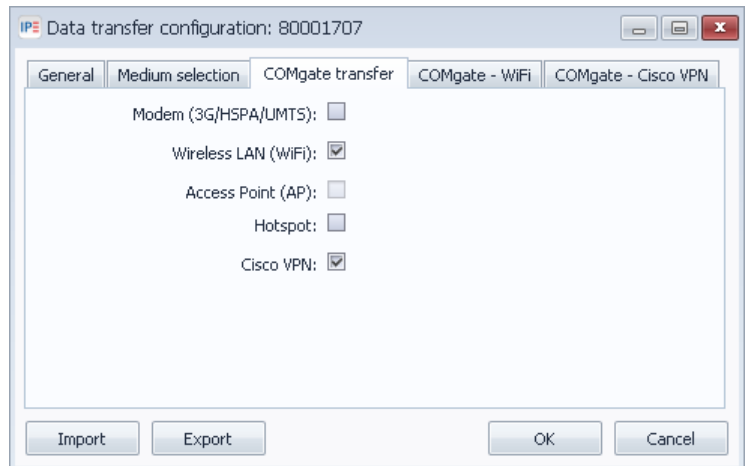
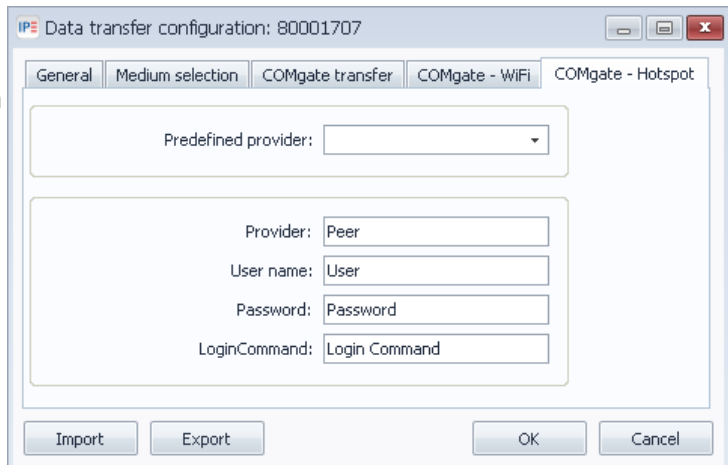

COMgate - Cisco VPN

Gateway IP address

Network IP address of the gateway used for data transfer.

User ID

User identification

Key (PSK)

Pre-shared key used by two different peer systems identifying each other.

User name

User name to access the account.

Password

Password to access the account.

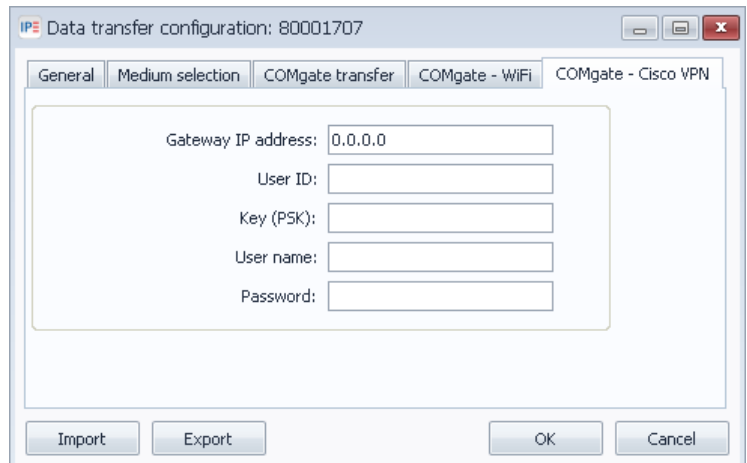

9 Display modules

9.1 M-VIEWfleet

M-VIEWfleet is a alphanumeric data display, which is connected to the USB of the logger. M-VIEWfleet provides different displaying modes besides four status LEDs and buttons. The number of displayed channels is only limited by the processor load.



Only connect M-VIEWfleet to the logger if logger is switched-off. In case M-VIEWfleet is connected to logger during operation, the USB interface can be damaged.

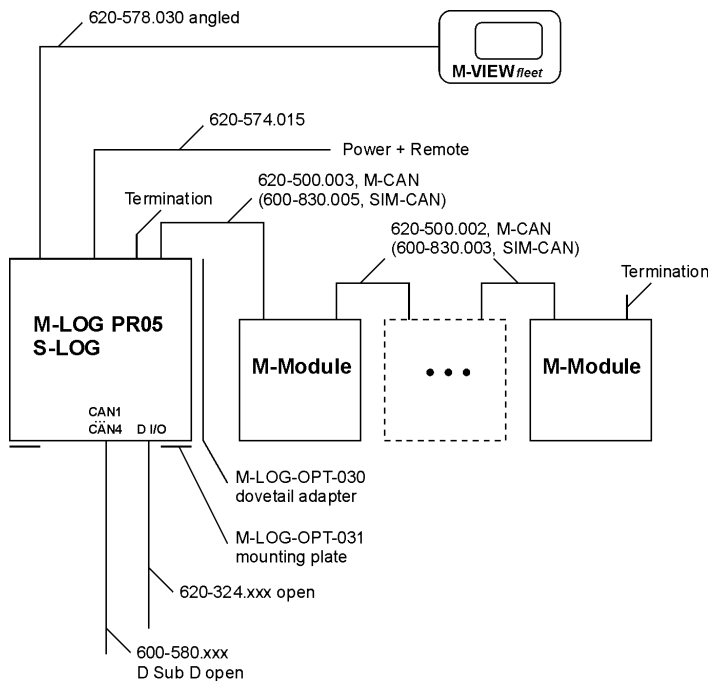

M-VIEWfleet is connected to M-LOG with a USB 2.0 interface. A second USB port of the logger is available at the display. USB 2 is used for e.g. a program update or to exchange measurement or configuration data via USB flash drive. USB connections are designed for a maximum length of 5 m. Display settings are defined in the system configuration.

9.1.1 Keys and LEDs

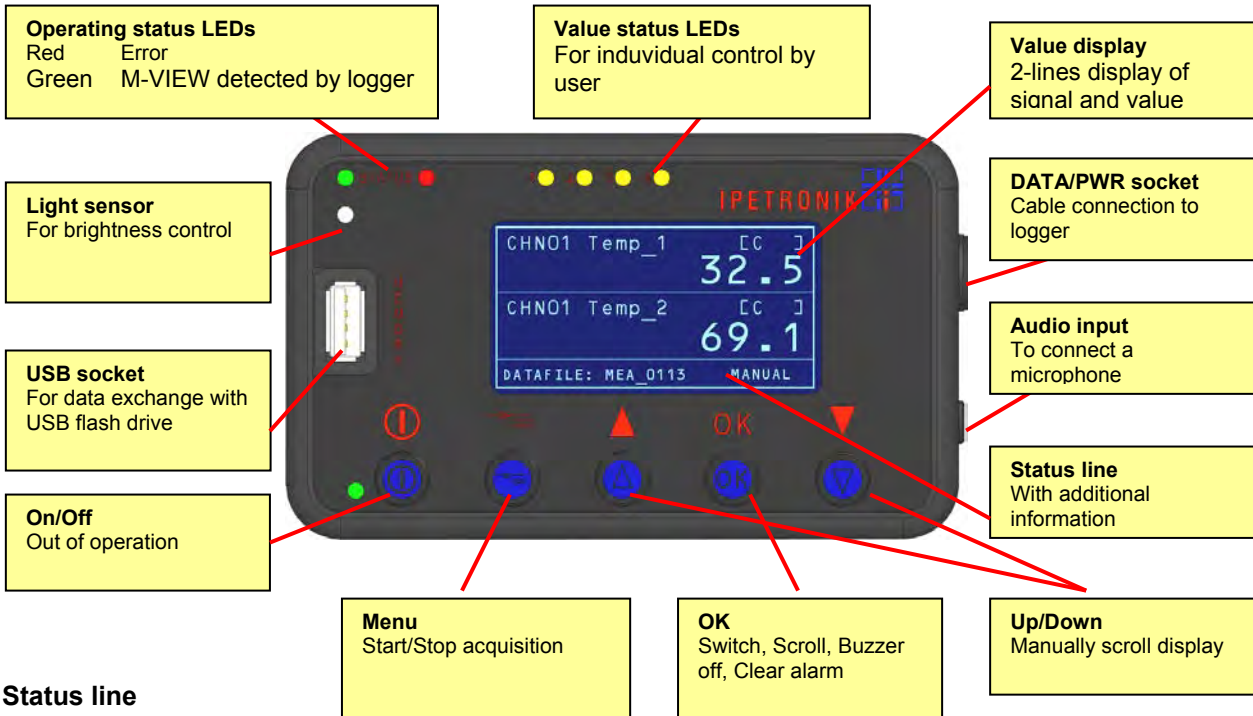

Status line

The scroll mode **MANUAL** (with Up/Down keys) or **AUTO** (automatically) is displayed in the right zone of the status line. The following information is alternately shown in the left zone:

- DATAFILE Name of current data file
- TIME LEFT Available time in days (D) and hours (H) for data recording
- DRIVER Selected driver
- SHIFT Selected shift (track or road sections belonging together)

OK

Function in standard display

1. Display Min/Max Press longer than one second
2. Back to standard display Press longer than one second

Function in standard display in scroll mode AUTO:

(Changed from AUTO to MANUAL with Up/Down keys)

1. Back to auto scroll mode Press longer than one second

If the key is not pressed, the display changes after 30 s into auto scroll mode.

Switching from MANUAL to AUTO is only possible if auto scroll mode has been activated!

Function at configured alarm limit values:

1. Buzzer off Shortly press to switch-off buzzer
2. Clear alarm Press longer than one second, Back to standard view

If the alarm has already been cleared 5 times, a final message appears to definitely delete the alarm.

Up/Down ▲ ▼

- One line up ▲
- One line down ▼
- Switch AUTO > MANUAL ▲ or ▼ if AUTO (Auto scrolling) has been activated in configuration

Menu

Stop acquisition -> Press longer than two seconds

Start acquisition -> Press longer than two seconds



*The option **Allow start and stop of acquisition** must be activated in the configuration. The measurement file number is increased by one at every acquisition start. If the option **Track** or **Track/Driver** (List type selection) is additionally selected, files can be merged to one file until the final end of data recording.*

*Devices connected to the logger **remain switched-off until acquisition stop.***

Operating status LEDs

- Red
 1. Error
 2. Logger is booting, initializing M-VIEW
- Green Operation, M-VIEW detected by logger

Value status LEDs

The 4 status LEDs can be controlled with calculations. Additional limit violations can therefore individually be displayed.

9.1.2 Configuring M-VIEWfleet

- ▶ Select Display in the tree structure.
- ▶ Select Add components.
- ▶ Select M-VIEWfleet.
- ▶ Select the desired signals.
- ▶ Confirm the desired signals with **OK**.



Define the alarm values for the upper and lower signal limit, if desired. If the current signal reaches the alarm limit, the display changes into the message window and the buzzer sounds. Clear the alarm with OK.

Activate the detection of the minimum and/or maximum values for the respective signal. With pressing OK, the display changes into showing the minima and maxima. If the detection has not been activated, -----,-- is shown. Pressing OK again changes back to standard display.

Define status LEDs for limit display

The 4 status LEDs can be activated by separate and user-defined calculation formulas. Additional thresholds can therefore be defined and reaching these limits can optically be signaled. In addition, the LEDs can be used as status display for the 4 digital logger outputs.

To do so, the following options are available:

- ▶ Use the same formula like at the corresponding digital output
- ▶ Status query of digital output to 1 (LED ON, for the time digital output = 1)

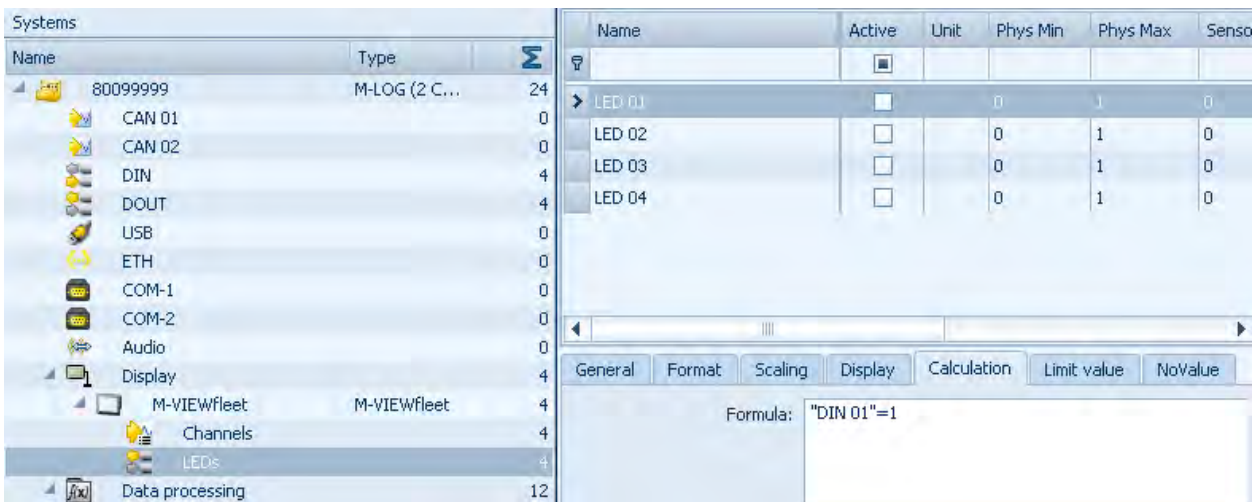

Setting display modes

Select **Active** to use M-VIEWfleet in the configuration.



No further settings can be defined without activating M-VIEWfleet! If an existing M-VIEWfleet configuration is deactivated, the logger display has no function! This is signaled by the red LED. The red LED is also on if the USB port is damaged during operation by disconnecting the cable.

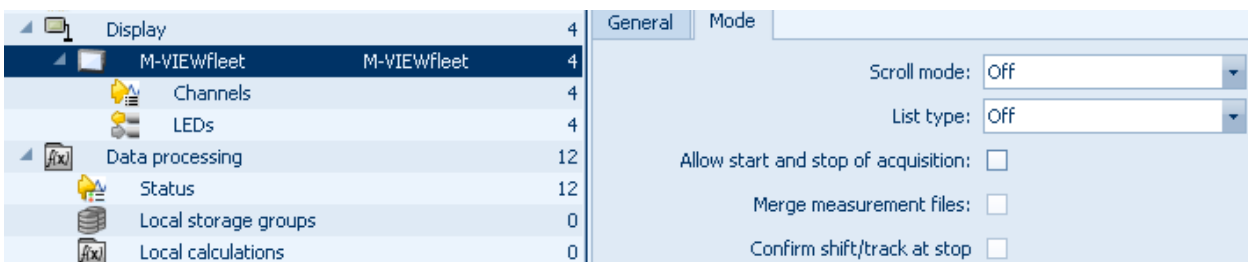

Scroll mode

Off	Manually switching lines with Up/Down
5 s	Continuous line switching in interval of 5 s, display moves line by line from the bottom up in order of signal list

List type

Off	Neither track nor driver defined
Track	Track selection by driver is assigned in data
Track/driver	Track, as well as, driver are selected before start and set in data

The text file of the track selection list is defined in:

...\IPETRONIK\IPEmotion MAL-PlugIn IPETRONIK LOG V03.xx.xx\Data\MViewfleet\MVIEWfleetTracks.txt

The text file of the driver selection list is defined in:

...\IPETRONIK\IPEmotion MAL-PlugIn IPETRONIK LOG V03.xx.xx\Data\MViewfleet\MVIEWfleetDrivers.txt

Changes of the entries can manually be defined in the respective text file.

Allow start and stop of acquisition

Pressing the menu key stops the data storage and the current measurement file is closed.

Pressing the menu key again starts the next data storage and the number of measurement file is increased by one.

Merge measurement files

This function requires a selected list type!

The end of every acquisition includes the **End Shift xxx** query. If it is confirmed with OK, all previous partial acquisitions of one file are merged and the number for the next measurement file is increased by one. If this function is not activated, an own file is written after every acquisition stop and a following acquisition is recorded with a new number.

Confirm shift/track at stop

A selected list type is required for this function and *Merge measurement files* must be activated!

The query runs after acquisition stop:

End Shift xxx!	Yes OK?	Track is stopped, partial acquisitions are merged in one measurement file
	No OK?	Track is continued at next start with same measurement file

The query runs after acquisition start:

Shift xxx Good Trip!	OK?	Currently saved track is continued with new acquisition file
	Change OK?	Track and driver can be selected again



If nothing is entered after a query, an acoustic message sounds after 20 s and the saved settings are accepted for the next acquisition.

9.2 IPEconnect (Online display with Smartphone or tablet)

IPEconnect serves as an online display for IPETRONIK data loggers. The system consists of the components data logger (M-LOG, IPElog, FLEETlog), IPEhub2, corresponding connecting cables and the mobile device (Smartphone, tablet) with the IPEmotion App.

9.2.1 Overview

- ▶ Smartphone / tablet for online data visualization of the data acquisition running on the logger
- ▶ WiFi access point IPEhub2 as gateway from the logger to the Android display
- ▶ System configuration with IPEmotion
- ▶ Quick installation, easy and stable operation

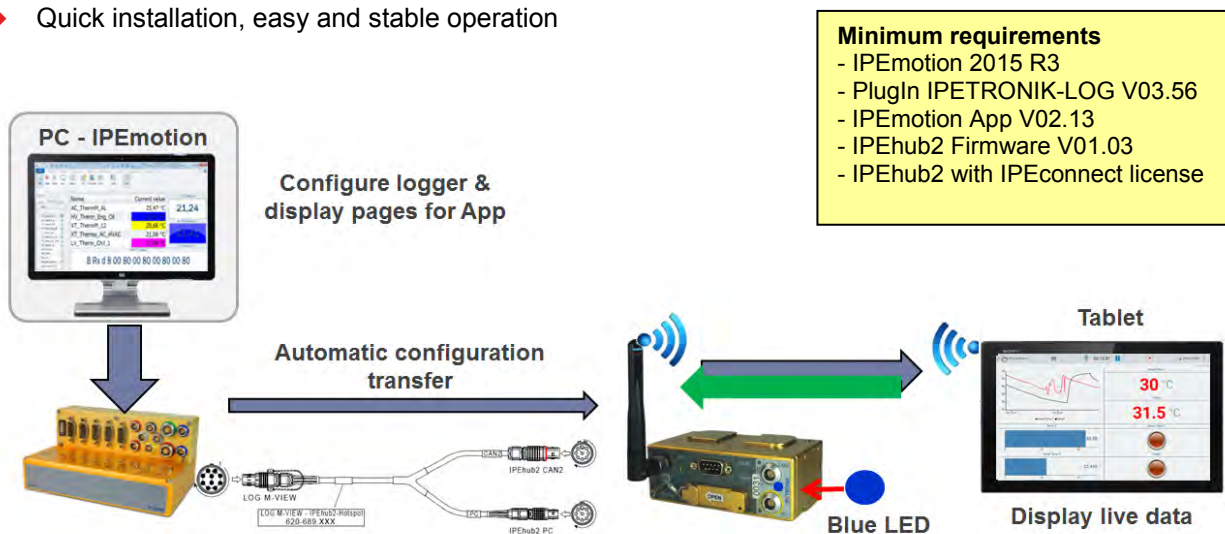

9.2.2 Features

- ▶ Creating the data configuration (online data) based on the logger measurement configuration.
- ▶ The IPEmotion App imports a new configuration automatically.
- ▶ Creating the configuration for the online visualization with the mobile device.
- ▶ The blue LED at IPEhub2 indicates a successful WiFi connection.
Name of the network / SSID: Logger_[Serial_number]
- ▶ The app configuration on the smartphone / tablet is saved on IPEhub2.
- ▶ Shortly after the app has been started, it shows all defined values.
- ▶ IPEhub2 can be connected and disconnected at any time (even during a running measurement).
- ▶ If a connection is disturbed or interrupted, IPEhub2 will re-establish the WiFi connection immediately.

9.2.3 Cables

620-689.xxx LOG-VIEW Cable IPEconnect (M-LOG, M-LOG V3, IPElog)

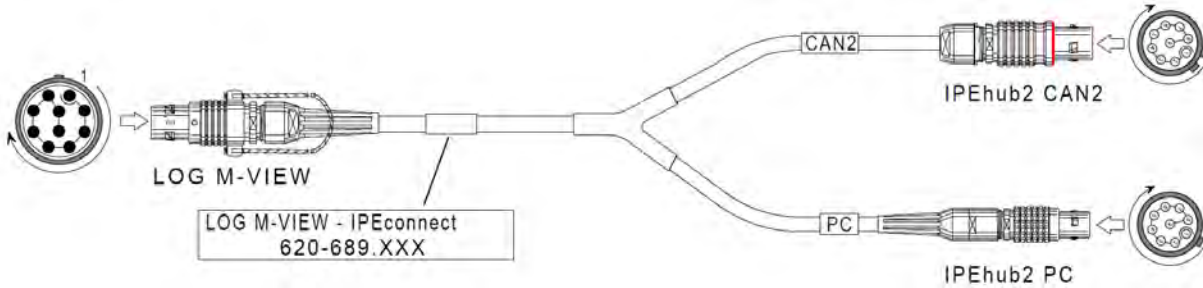

620-691.xxx FLEETlog-VIEW Cable IPEconnect (FLEETlog, FLEETlog2)

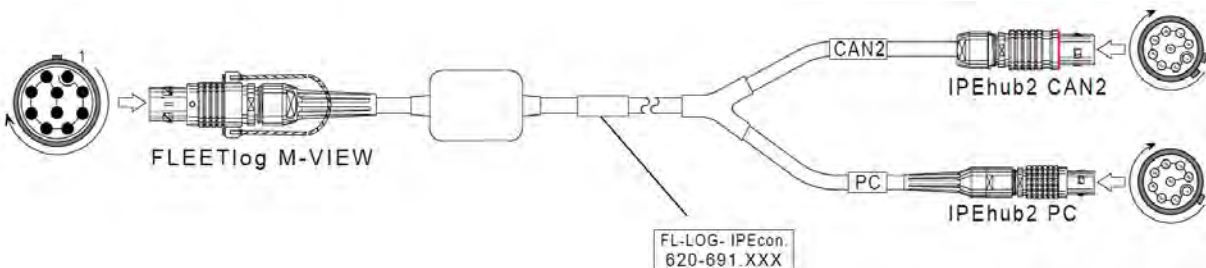

9.2.4 Settings

Logger USB interface

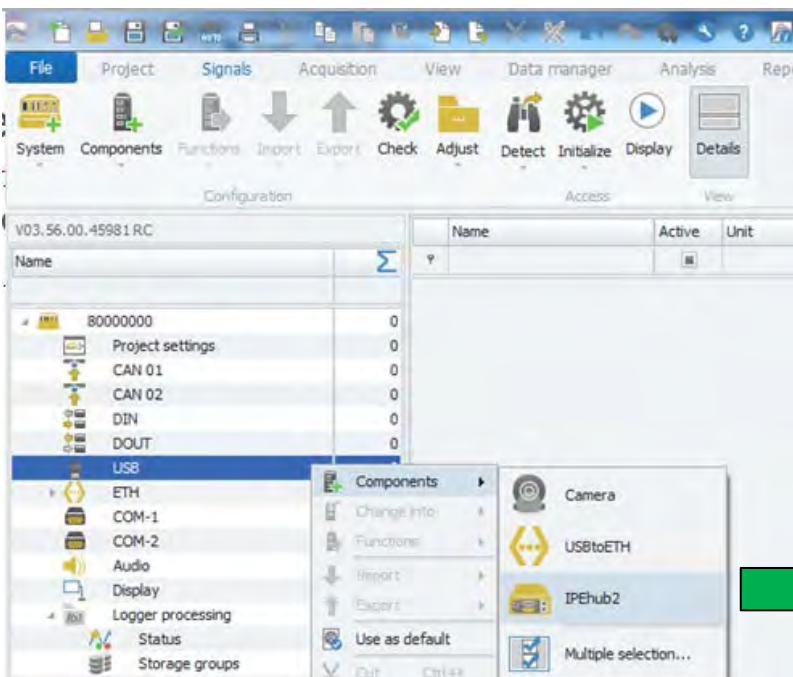

- Setup IPEhub2 at the logger's USB interface

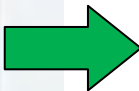

Name	Active	Unit
80000000	0	
Project settings	0	
CAN 01	0	
CAN 02	0	
DIN	0	
DOUT	0	
USB		
ETH		
COM-1		
COM-2		
Audio		
Display		
Logger processing		
Status		
Storage groups		
Components		
Camera		
USBtoETH		
IPEhub2		
Multiple selection...		
Change info		
Functions		
Report		
Export		
Use as default		
Out		
Copy		
USB	0	
IPEhub2	0	
XCP service	14	
DAQ list slow	2	
DAQ list medium	12	

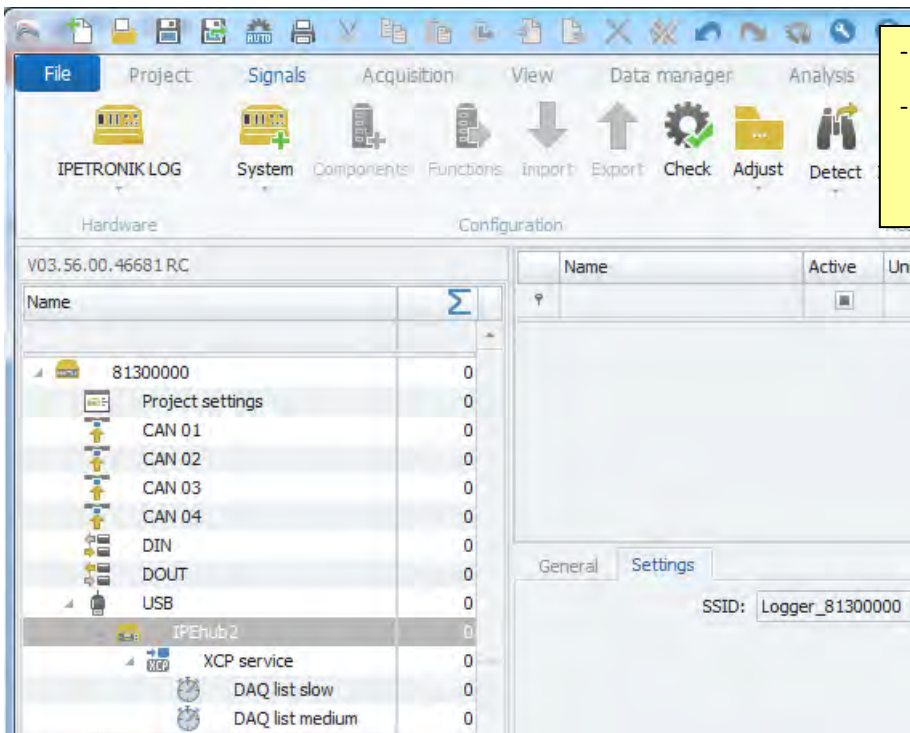

App export

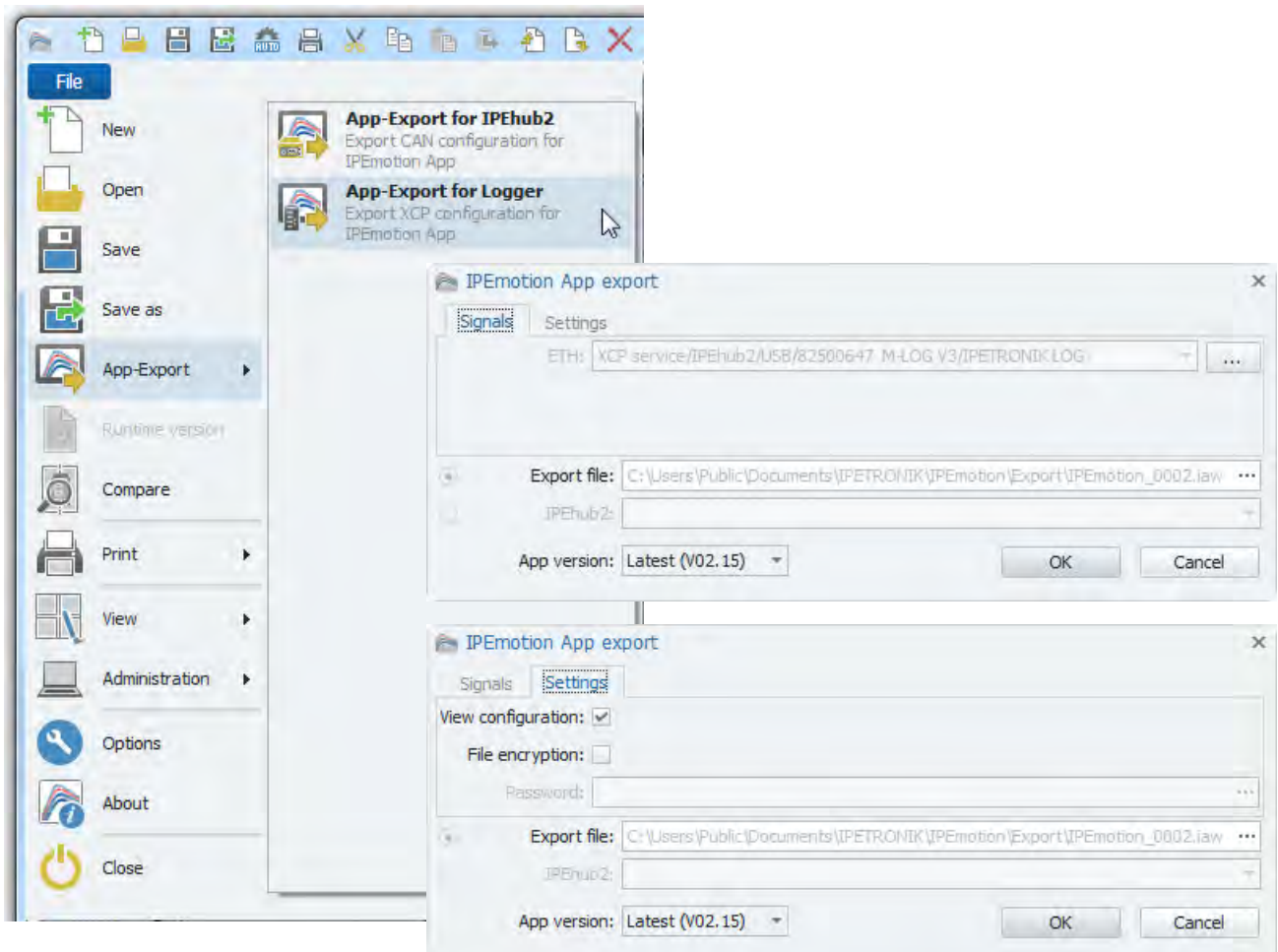

9.2.5 App display

The app shows consecutively signal values as soon as the WiFi connection is established and the logger is operating in measurement mode.

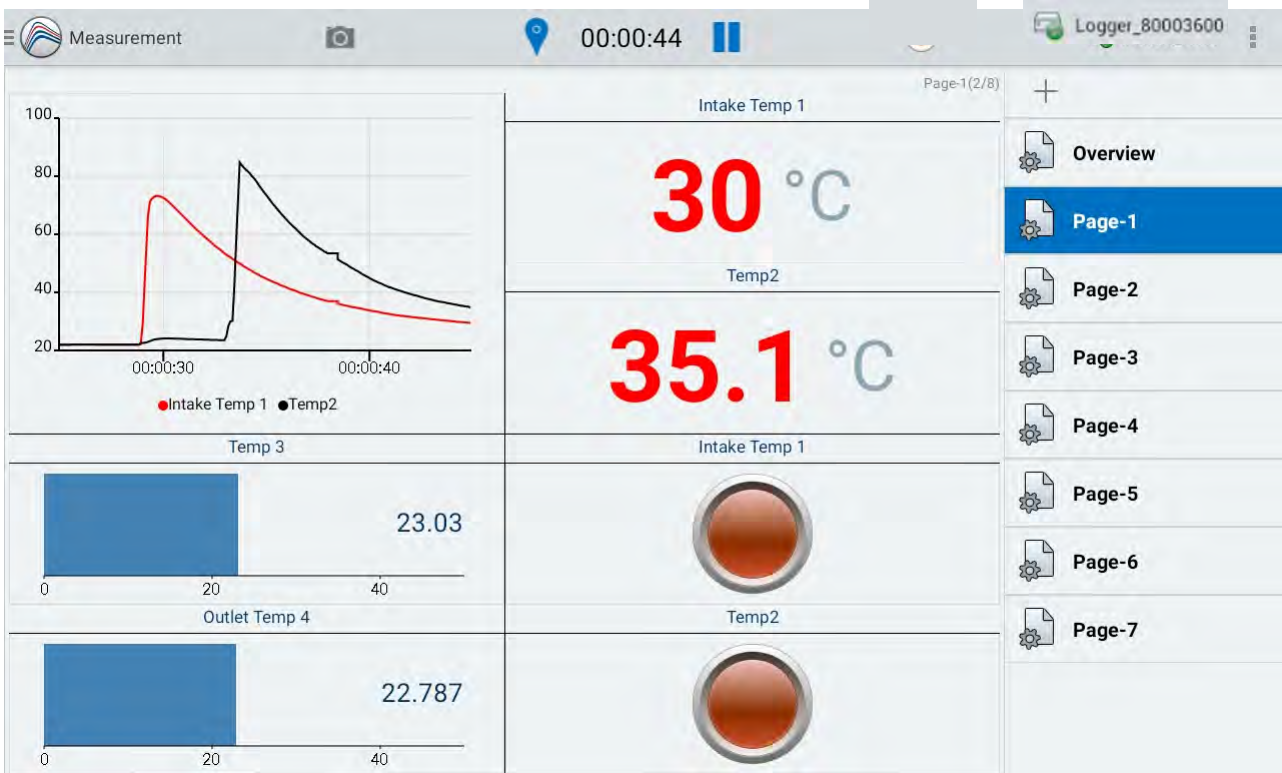

9.3 Connecting displays via openABK

With the implementation of the protocol openABK (short for open display and operating concept) in the PlugIn IPETRONIK-LOG V03.60 (and corresponding TESTdrive V03.60) standard displays that are supporting this protocol (e.g. the EMBU-Sys displays from the CANDICE series) are supported.

9.3.1 Cable connection

The display can be used for data loggers IPElog2, M-LOG V3 and FLEETlog2 with an USB2ETH cable connected to the VIEW socket of the logger.

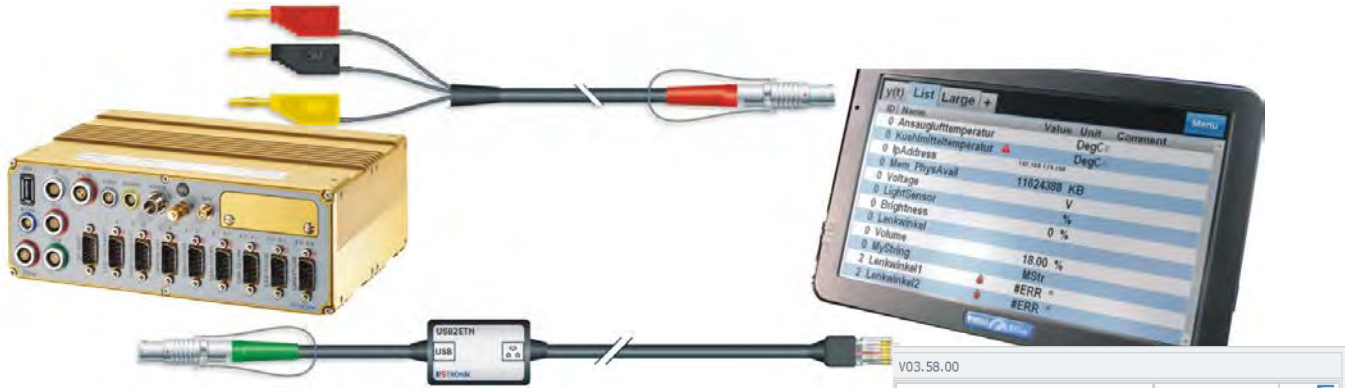

9.3.2 Display configuration

The configuration of the measurement data visualization is set by the software of the display manufacturer. For CANDICE the EMBU-Sketch software offers an individual configuration of display instruments and function buttons. Furthermore, the display has to be created within the logger configuration by adding an USB component.

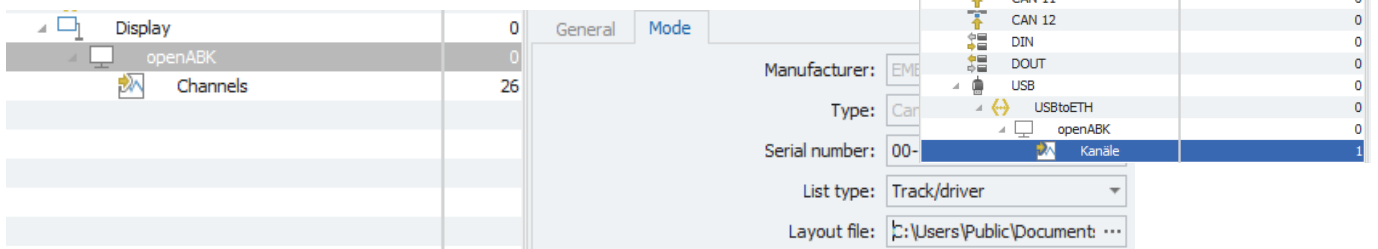

9.3.3 Use display buttons for triggering

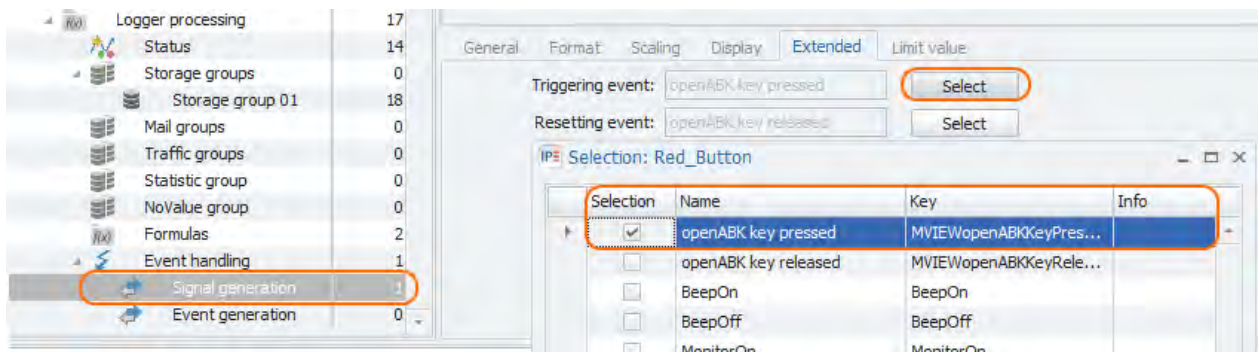

10 Accessories

10.1 Electrical accessories

10.1.1 COMgate

COMgate is an intelligent extension device for logger and allows remote transmission of measurement and configuration data.

M-COMgate in mounting enclosure for M-LOG

COMgate is available in 2 versions:

COMgate WLAN acc. to WiFi 802.11 a/b/g

COMgate WAN WLAN acc. to WiFi 802.11 a/b/g
and modem for GSM/GPRS/3G

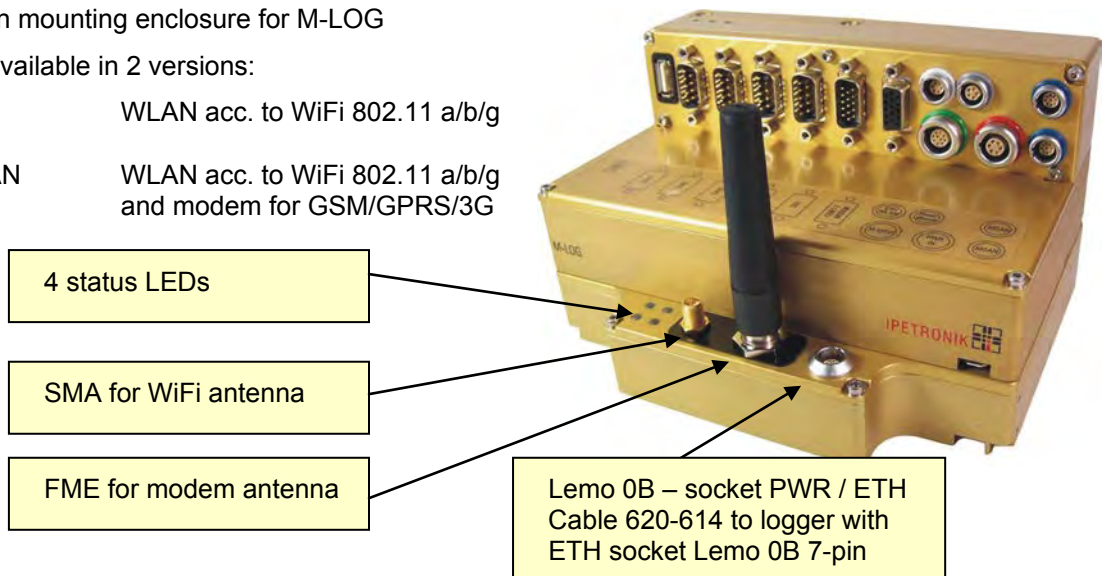

LED status display

LED display	Status	Meaning
GREEN	PWR ON	Device is ready for operation (operation: see LED yellow or orange)
■ ■ ■ ■	MODEM	Establishing connection to UMTS/GPRS network
■ ■ ■ ■ ■	MODEM	Successfully registered to UMTS/GPRS network
ORANGE	MODEM	Steady connection
■ ■ ■ ■	WiFi	Establishing connection to WiFi network
■ ■ ■ ■ ■	WiFi	Successfully registered to WiFi network
YELLOW	WiFi	Steady connection.
RED	ERROR	Interference, potential reasons are: - transfer of new configuration - wrong configuration loaded - general operating interference



M-COMgate requires additional external cooling on M-LOG at operating in ambient temperatures > 70 °C (158 °F)!

10.1.2 Extender

CAN-Extender

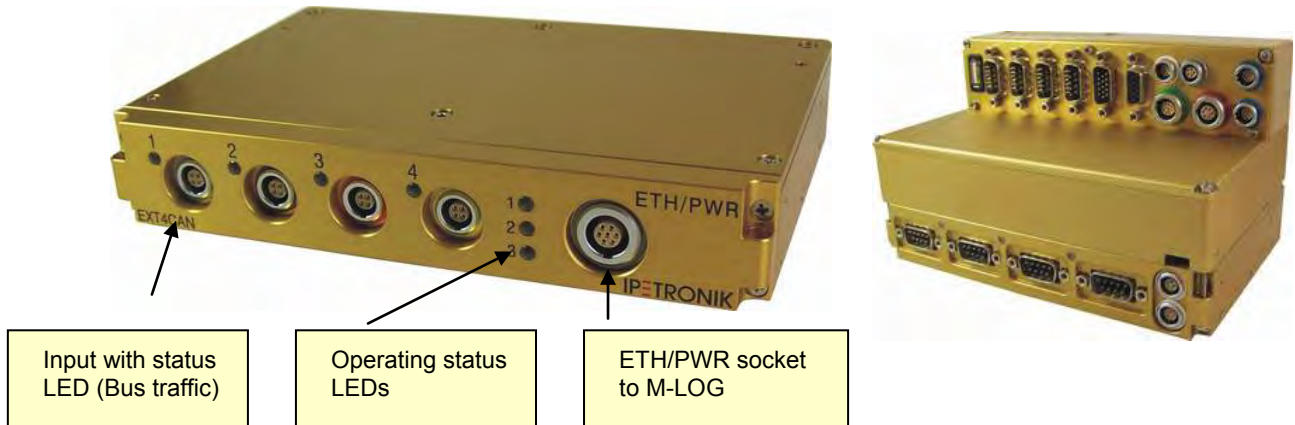

M-LOG Extender is an extension device with 4 additional CAN inputs. M-LOG devices, which are already equipped with a LX800 processor board, as well as, the option Input 2x Ethernet, can be extended without modifying hardware. The extender is screwed to the bottom of the basis device with 4 screws and connected to the logger with the cable 620-406.002 (here PR08, or 620-404.002 for PR03 and 620-405.002 for PR04).

Requirements

- ▶ Data logger with LX800
- ▶ Option Input 2x Ethernet (with respective port replicator)
- ▶ free Ethernet input
- ▶ IPEmotion + LOG-PlugIn ≥ 03.19 (Creation and configuration see ETH 01/02 port)

Advices

- ▶ The bus inputs of the extender do not support WakeOnCAN and traffic acquisition.
- ▶ Data is directly stored on the logger.
- ▶ The maximum data rate is 100 Hz.
- ▶ The configuration is extended by the additional file *.ecf (Extender Configuration File).

10.1.3 IPEwifi

IPEwifi is as wireless extension for IPETRONIK data loggers (M-LOG, S-LOG) supporting radio data transfer using the WiFi standard 802.11 b/g.

Measurement data is transferred on command or automatically without any cable connection to a network access point. IPEwifi acts as a communication bridge and forwards measurement and configuration data. IPEwifi itself neither supports router functions nor subnetworks.

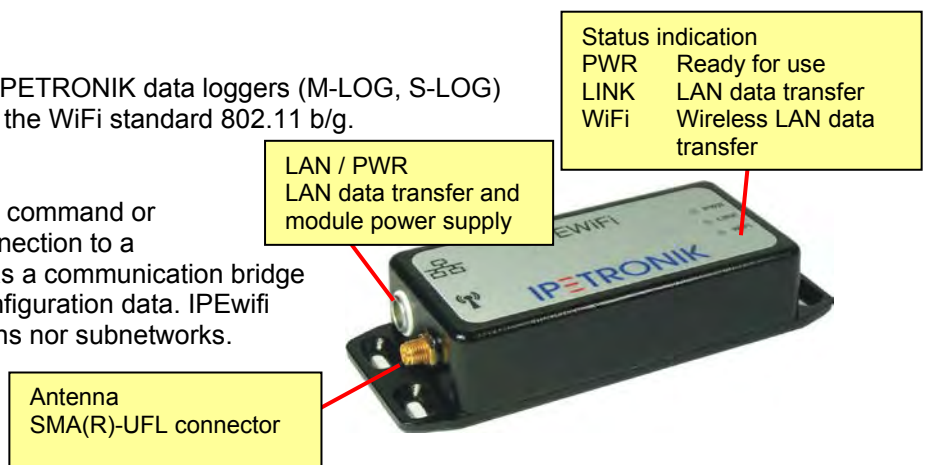

IPEwifi setup via web browser,
 ► refer to separate manual IPEwifi

Setting up a LAN connection for the logger

IPEwifi operates in bridging mode (means as LAN cable substitution), thus logger settings are similar to a direct LAN connection to the network connection point.

- ▶ Start IPEmotion
- ▶ Open an existing logger configuration or create a new one
- ▶ Highlight the logger in the left hand system structure
- ▶ Move to the configuration dialog (right hand lower area) with the **Data manager** tab, activate the check box **Update connection parameters** and click the **Configuration** button.
- ▶ Click to the **Medium selection** tab and activate the **LAN** check box.
- ▶ Activate the check box **Get IP address automatically**
- ▶ Confirm and close with the **OK** button.
- ▶ Transfer the current settings to the logger.

This settings enable the logger to receive its IP address through IPEwifi using DHCP services of the network server.

Connecting IPEwifi and the logger with a LAN/PWR cable

- ▶ Connect IPEwifi with the logger as shown below.
- ▶ As soon as switched on, the green LED lights permanently.
- ▶ The yellow LED indicates a properly working LAN connection.
- ▶ The orange LED indicates a properly working WiFi connection.

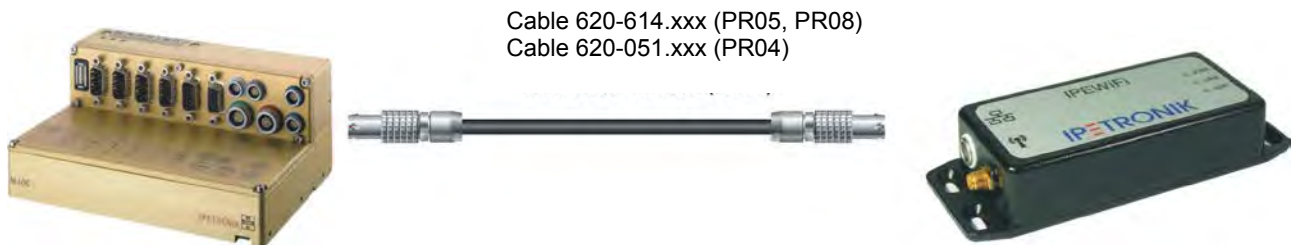

*Depending on the logger settings under **COMgate switch-on condition** from the **System activated** tab, IPEwifi will be supplied with power by the logger*

Acquisition	<i>during the measurement,</i>
Postprocessing	<i>during data post processing, as soon as measurement is stopped, (follow-up time is running),</i>
Always	<i>as soon as the logger has started.</i>



If the logger is not able to communicate with the network, although the settings are correct and the WiFi connection is steady (indicated by the orange LED), please check the entries of the log file (MEA_xxxx.log).



As former M-LOG devices with port replicator PR05 have a 6-pin Ethernet connector, a direct connection (single cable) using the cable 620-614.xxx is not supported. Only devices with 7-pin Ethernet connector provide the lines (Pin 6 and 7) for the IPEwifi power supply.

10.1.4 GPS receiver

- ▶ GPS mouse for satellite positioning
- ▶ Connection to the serial logger interface
- ▶ Predefined settings of NMEA protocol configuration software



10.1.5 Bus isolator SAM-CAN-ISO

- ▶ High ohm connection of hardware to vehicle CAN
- ▶ Electrical isolation between vehicle bus and measurement system
- ▶ Connection with short stub
- ▶ Version "Hear only" to avoid unintended influencing of vehicle CAN



SAM-ISO011-23A0
 Has e1 approval (Vehicle Type Approval VCA) for directly connecting with the CAN bus of public vehicles without restricting the type approval.

10.1.6 iMIC

- ▶ compact multifunction device (1.57 * 1.44 * 0.98 in) (40 * 36,5 * 25 mm)
- ▶ Voice recording with audio input
- ▶ good voice quality
- ▶ illuminated trigger button
- ▶ 3 status LEDs (green, yellow, multicolor)
- ▶ integrated buzzer



Button (illuminated)

Triggering of data recording and/or voice recording via digital input 1.

Status LEDs

LED Yellow Indicates the status of digital output 2 (LED is on if output is active.)

LED Red Indicates the status of digital output 3 (LED is on if output is active.)

LED Multicolor

green Indicates the status of digital output 1 (green light)

blue Indicates the status of the yellow LED (blue light)

red Indicates the completed boot process. The excitation of the connected devices (at M-CAN or SIM-CAN socket) is switched-on.

Buzzer

Acoustically indicates the status of digital output 3 (Buzzer ON if output is active).



The specific functions of the digital inputs and outputs are defined in the measurement configuration (see [Standard functions](#) calculations, trigger, Use of digital inputs and outputs).



The button functionality, as well as, the LEDs and buzzer functionality also depends on the wiring / PIN assignment. If another cable than 620-607.xxx is used, functionality can differ from the one described above.

Cable 620-607.xxx

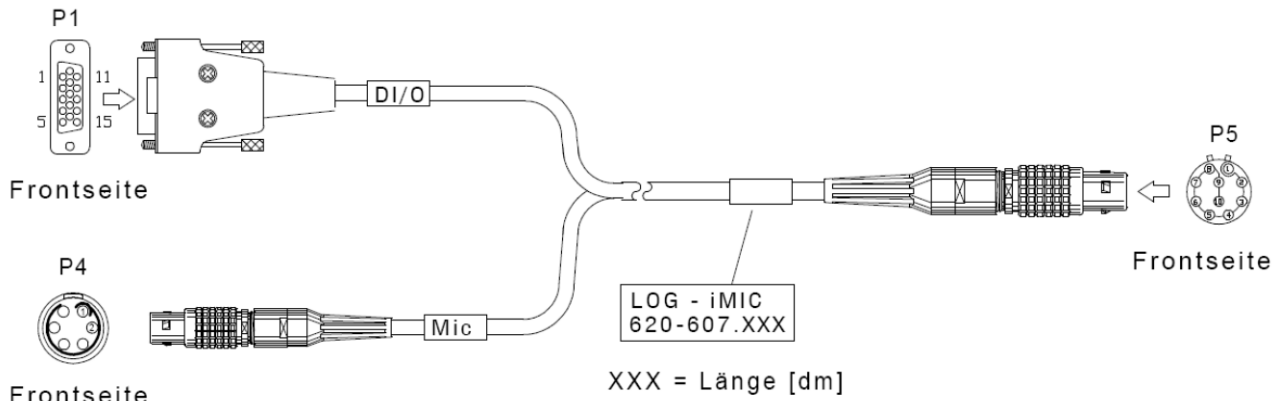

PIN assignment cable 620-607.xxx

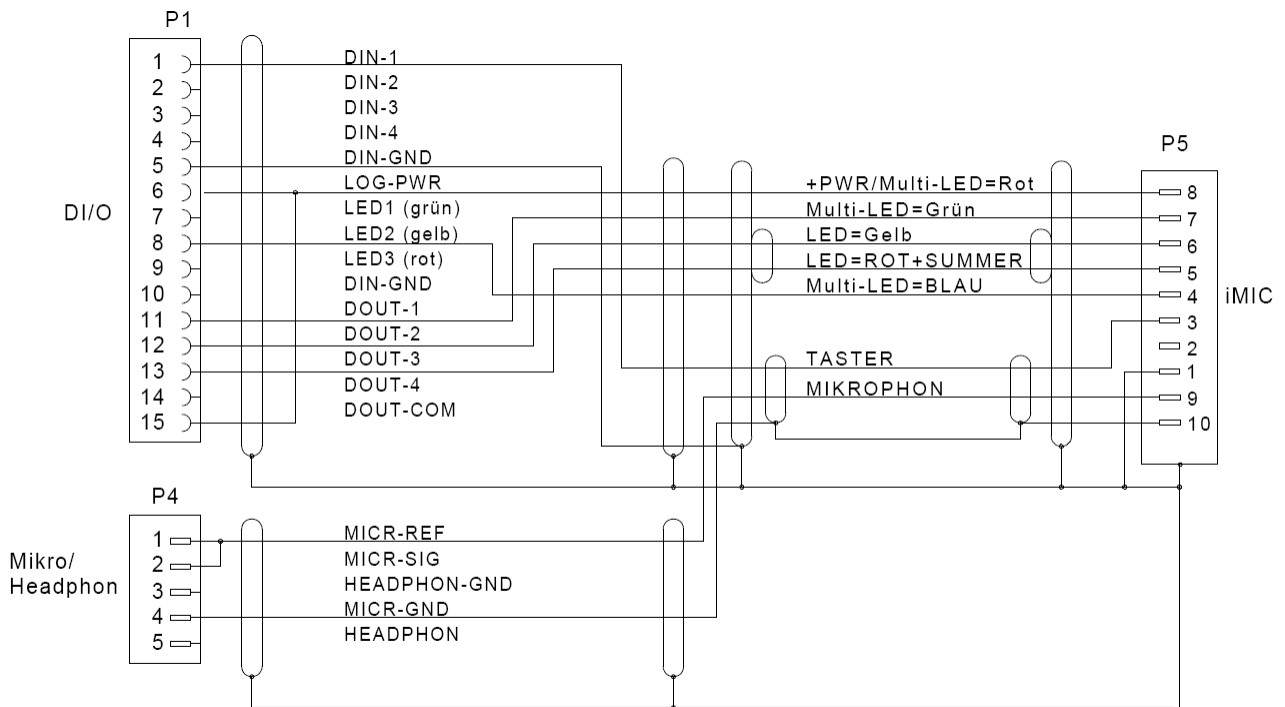

10.2 Mechanical accessories

10.2.1 Module mounting

Dovetail adapter



Adapter plate for mounting to the right M-LOG housing for connecting M devices without tools.

Fastening elements



2 fastening strips for mounting at the device bottom to screw M-LOG to an even surface.

Snap-in fastener



2 snap-in holders + 2 fastening strips for mounting at the device bottom to fix M-LOG at an even plate without tools.

Snap-in adapter

Mounting plate to use a snap-in fastener to fix M-LOG to plate without tools.

Suction pad holder for M-VIEWfleet / M-VIEWgraph

Suction pad holder with pump for fixing driver display on smooth surfaces e.g. at windshield.



Figures are subject to change!



Due to safety reasons, the bottom of the display housing must rest on an underlay (e.g. instrument panel). Avoid a free mounting and do not use the suction pad holder alone for drive tests.

11 New features

11.1 PlugIn / TESTdrive V03.56

11.1.1 Measurement data processing

Using several CAN send blocks with a single CAN knot

Data of a CAN knot can be send with different data rates (with the send block) or you can send CAN messages using different start IDs. CANdb export is supported per CAN knot (a description file containing all CAN send blocks) or per CAN send block (a description file per CAN send block).

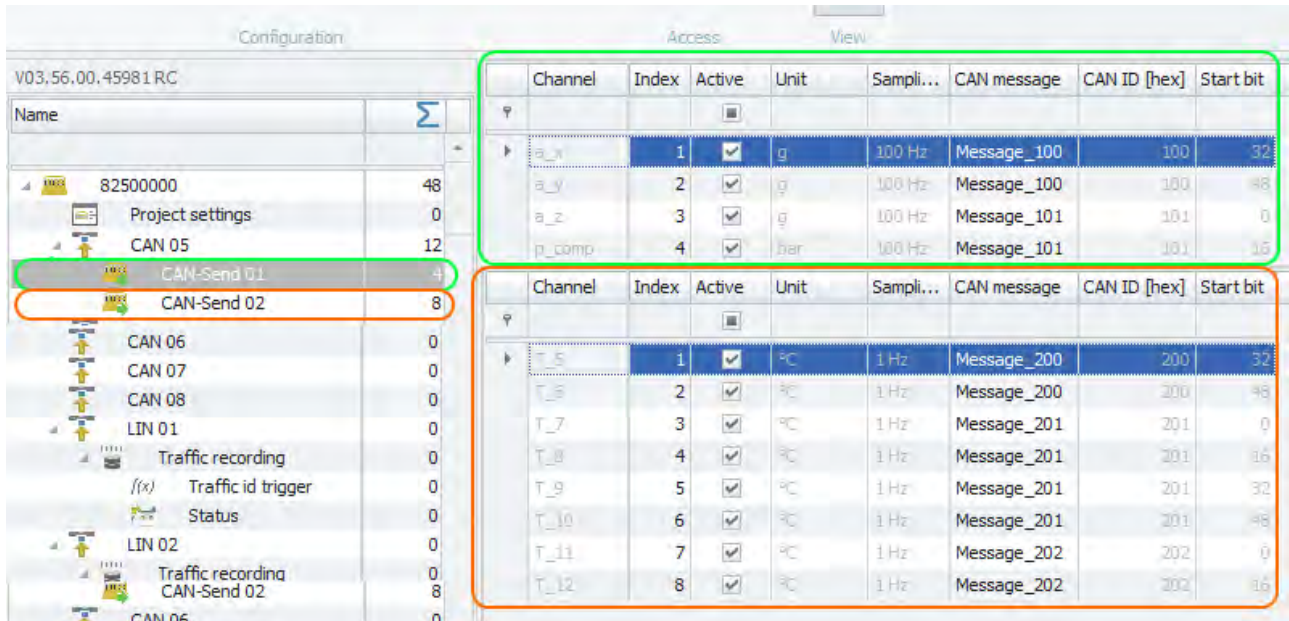

11.1.2 Status information (online)

Web interface

The logger's service web site shows status information, log file contents and a listing of active signals. A specific IPEmotion configuration is not required.

When using IPEhub2 (IPEconnect feature), the standard IP address **192.168.232.9** is used.

Alternatively the IP address, that has been assigned to the logger, can be used. Use the Ethernet branch in the system structure of the logger configuration to enter the IP settings.

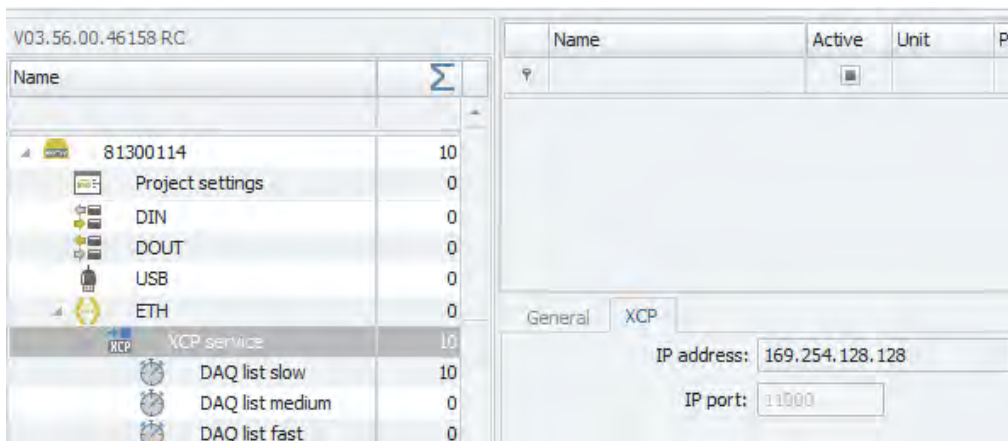

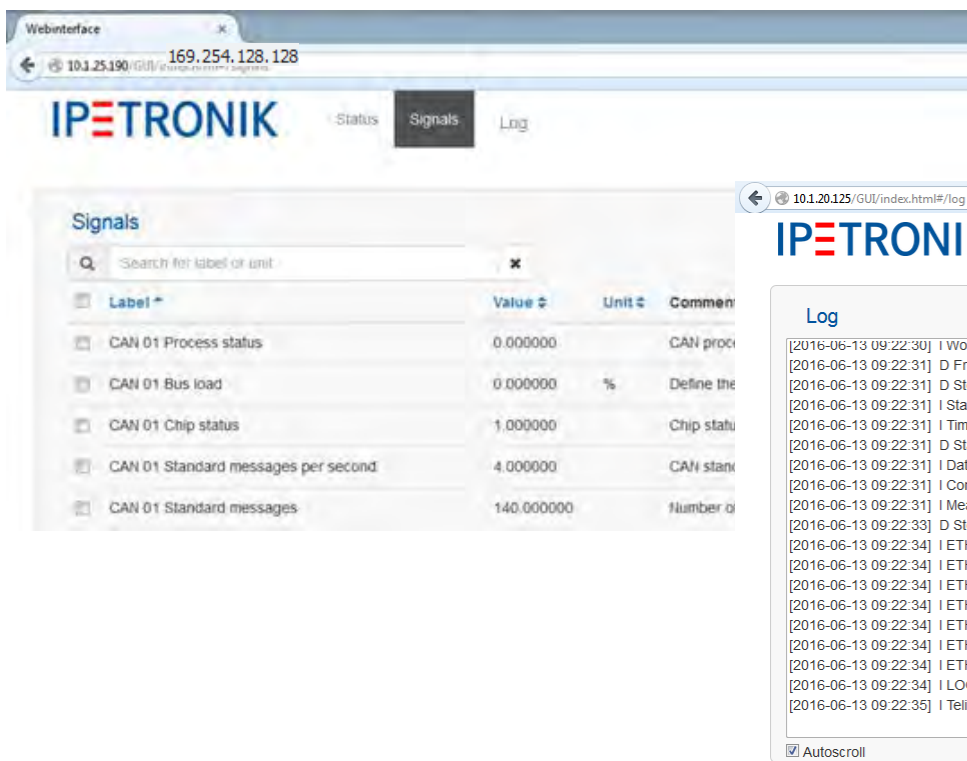
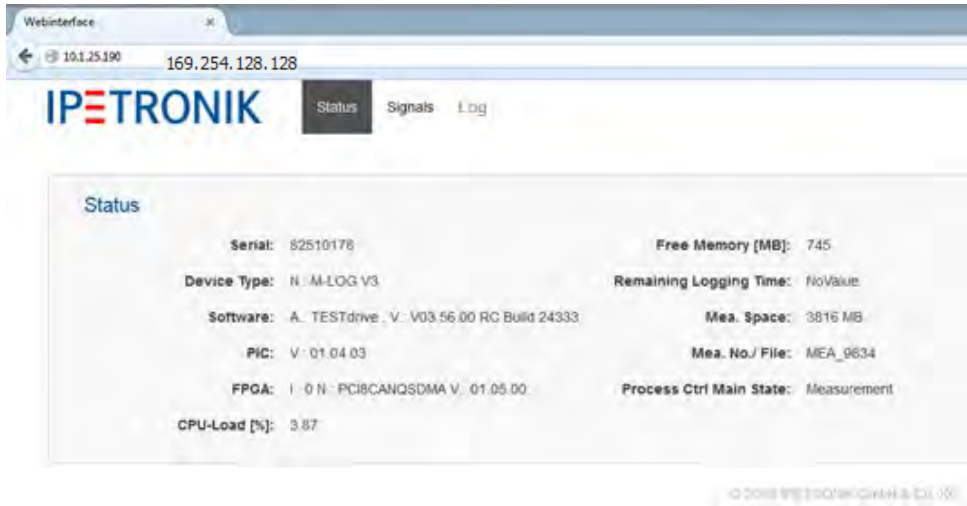

Sign of life and refresh rate

The status bar of the web interface shows the sign of life and the update cycle at the bottom left corner.

Refresh rate
Sign of live

Web service polling rate (signal request from the logger) in Hz
Text output indicating the connection status (online or offline),
The refresh cycle of the status indication is 10 s. During the status **offline** the refresh rate shows 0 Hz and signal values indicate „**Not available**“.



The decimal places of the signal values listed in the the web interface are configured by the respective channel properties. Go to the IPEmotion **Signals** area, select the channel, open the **Display** tab and enter the drop down menu under **Formatting** to choose the **Decimal places** settings.

PlugIn / TESTdrive V03.57

11.2.1 Measurement data processing

Using last value from previous measurement

For calculations under **Logger processing > Formulas**, the user can define, if the last measurement value of the previous acquisition should be used as the first value of the current measurement. This feature is not supported for calculating trigger conditions (switch-on conditions, activating storage groups). The parameter **Resetting behavior** is set for each calculation. Default setting is **At acquisition start** and corresponds to the formerly behavior (no use of values from a previous measurement). Selecting **At configuration change** means, that the value is not recessed by starting a new measurement, but definitely with a configuration update.

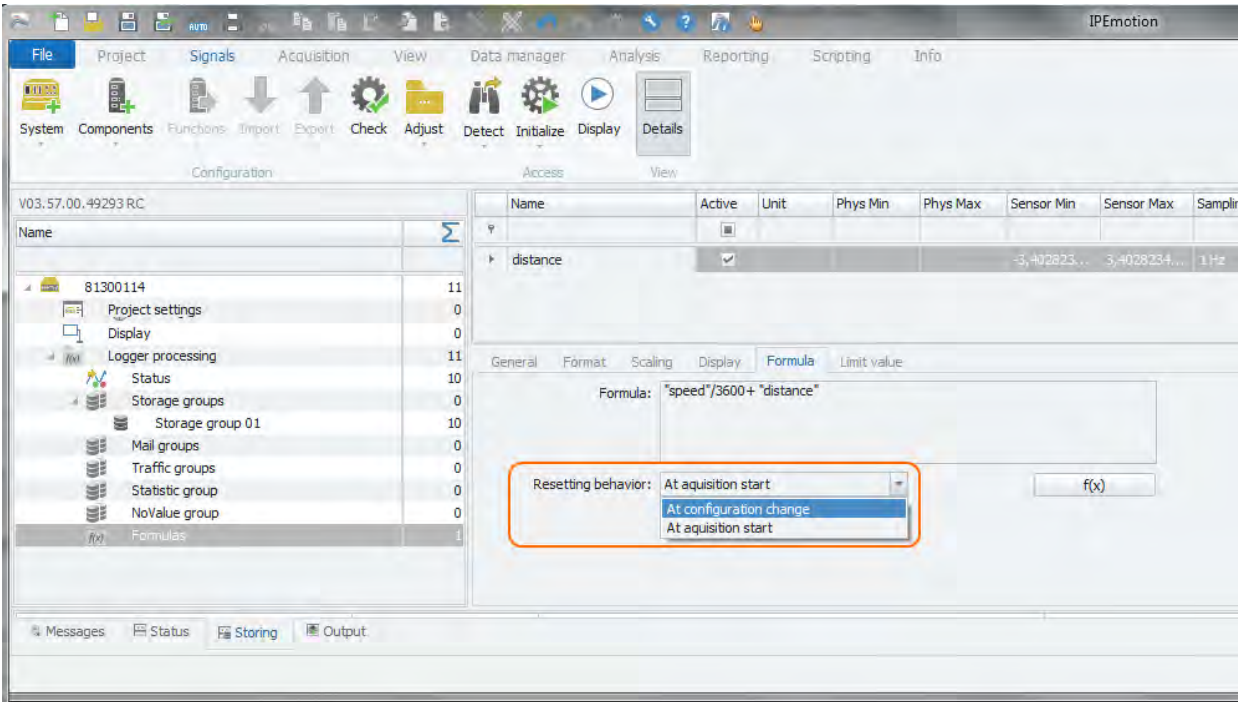

Release XCPonUDP import for USB2ETH adapter

The import of A2L description files is supported by an USB2ETH adapter.

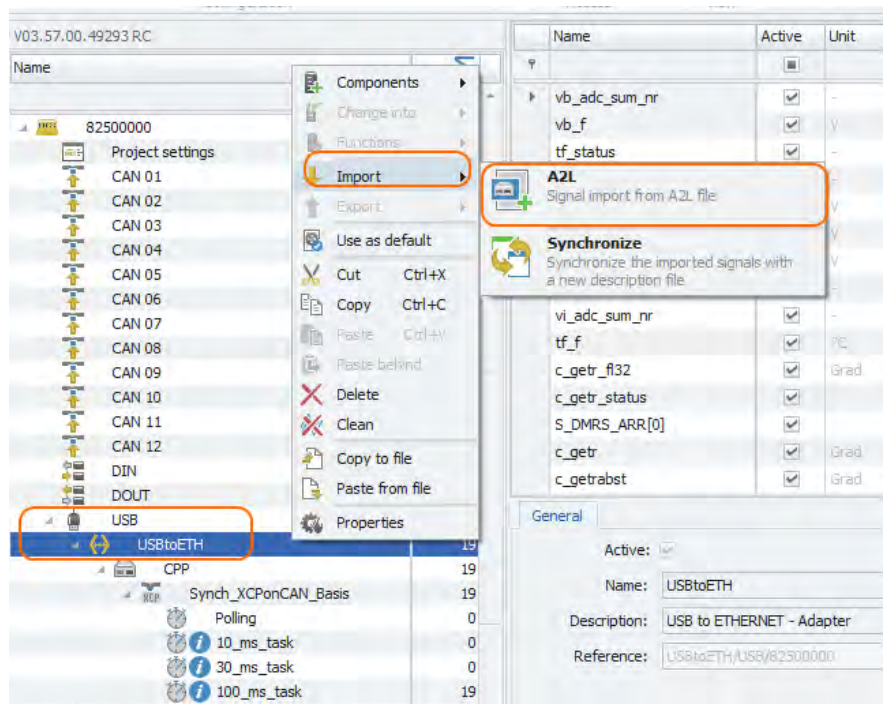

11.2.2 Data storage

Quick start recording

Depending on the traffic group settings, the Quick start feature records measurement data during the logger boot-up and between two consecutive acquisitions (previous acquisition is stopped but the following acquisition is not yet started). The modified function is now providing 3 options:

- **Off** No Quick start recording
- **ON** Quick start recording during boot-up and between measurements
- **Only at start** Quick start recording during boot-up only

The second option (**Quick start ON**) corresponds to the formerly behavior. Selecting **Only at start** will record data only during boot-up, not between stop and restart of an acquisition.

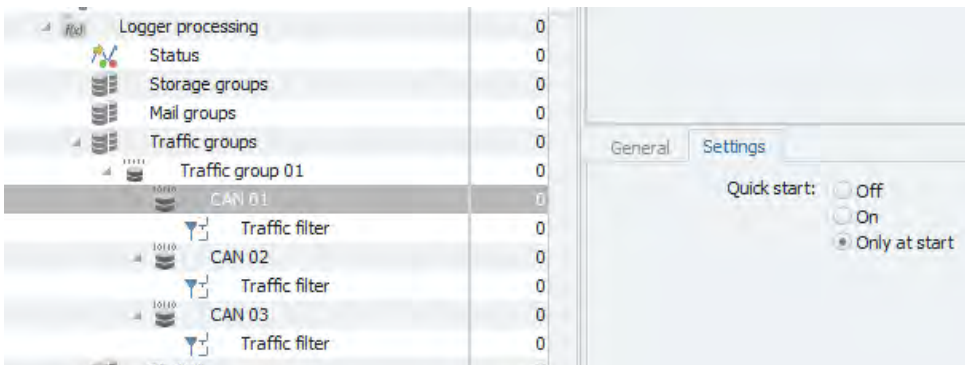

Post processing delay times

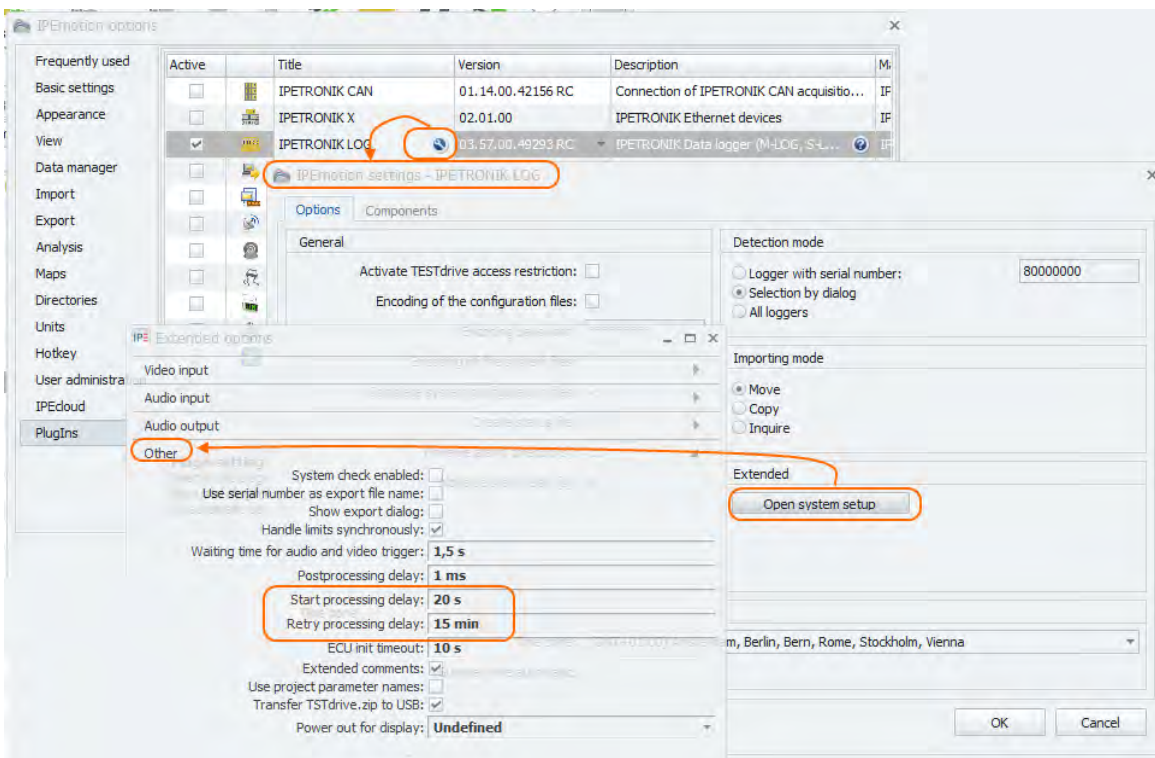

If the Postprocessing has been activated, two specific option can be defined.

- ▶ **Start Delay** The postprocessing starts with a delay of x seconds past to measurement start. Value has to entered in seconds. Default setting = 20 s. Valid range: 10 s – 5 min.
- ▶ **Retry Delay** Restart of the data transfer in case of the unsuccessful attempt (sample cause: FTP server unavailable, insufficient data rate, ...): Value has to entered in seconds. Default setting = 900 s. Valid range: 30 s – 30 min.

To modify the current settings, enter the extended systems settings under

Options > Plugins > Plugin IPETRONIK-LOG > Options > Open system setup

11.2.3 Data transfer & communication

WLAN status information

TESTdrive cyclically executes a WiFi SSID scan every 30 seconds in order to report all available WLAN networks and networks that are no longer accessible. The report only contains changes related to the previous scan. The log output of new connections is listed with SSID, alle channels and the signal strength (RSSI in dBm). Connections that are no longer available are listed with the SSID only. The WiFi scan feature is supported exclusively by data loggers with built-in WiFi device (no support for M-LOG/M-LOG V3 with COMgate/COMgate V3).

Sample of a log output:

New contact to WLAN network(s) :

```

SSID           Channel(s) (RSSI [dBm])
IPE-TESTING    ; 1 (-100); 5 (-65); 11 (-71);
Hotspot_Xdtfr  ; 1 (-98); 5 (-65); 11 (-71);
Testbench_PT25432 ; 11 (-69);
    
```

Lost contact to WLAN network(s):

```

SSID: IPEhub2_03561
SSID: Testbench_PT25377
SSID: Hotspot_Xdtfr
    
```

Category overview

Storage, traffic and statistic groups now provide the new tab **Categories**. Select a group and assign it to one or multiple transfer categories. The overview dialog shows all selected groups in the respective category.

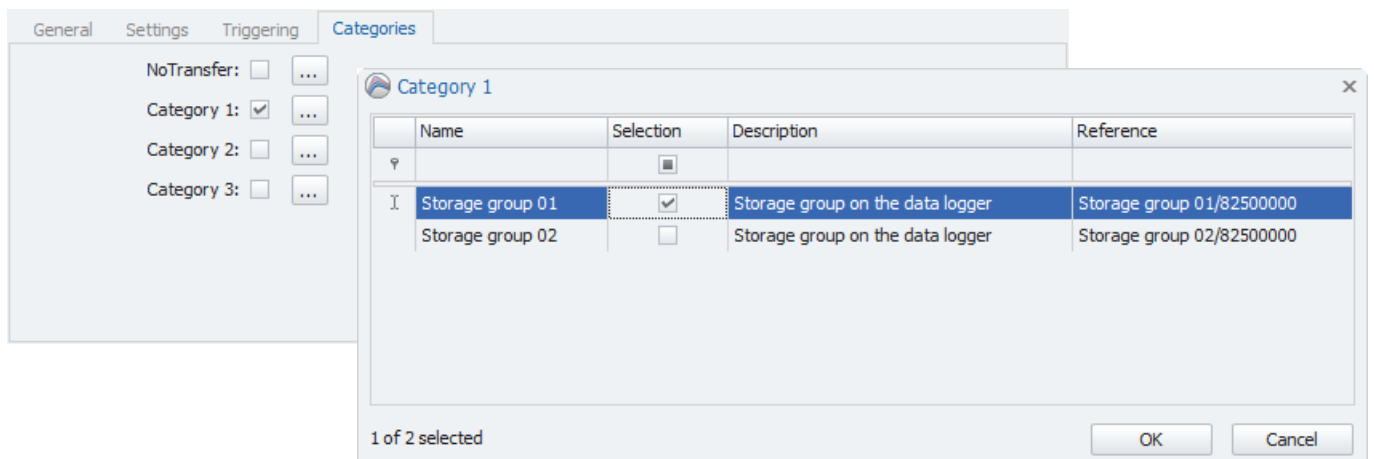

12 Appendix

12.1 Cable connection and Pin assignment

12.1.1 M-LOG port replicators

Port replicator PR05 (4x Sub D 9, PWR-IN/REM Lemo 1B 6 pin)

Internal circuits PR05

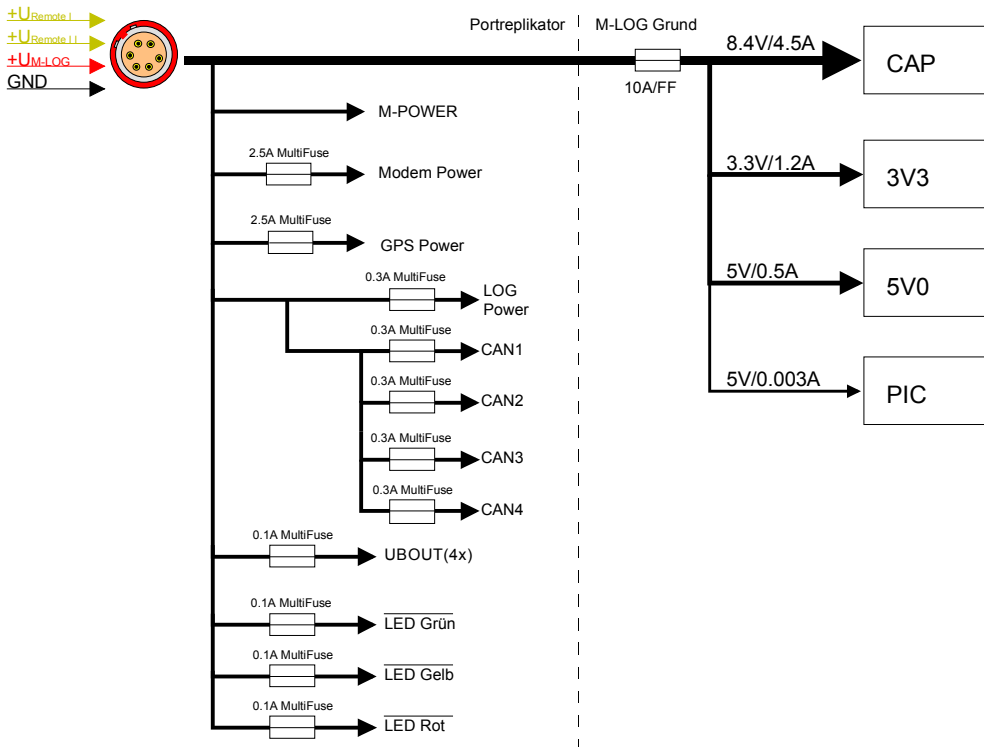

Cable reference PR05

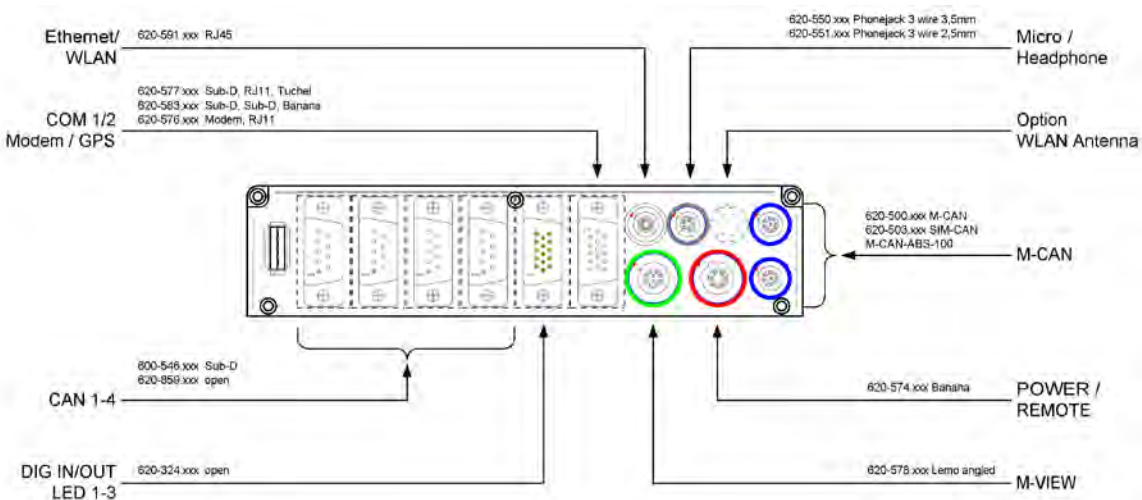

PIN assignment PR05

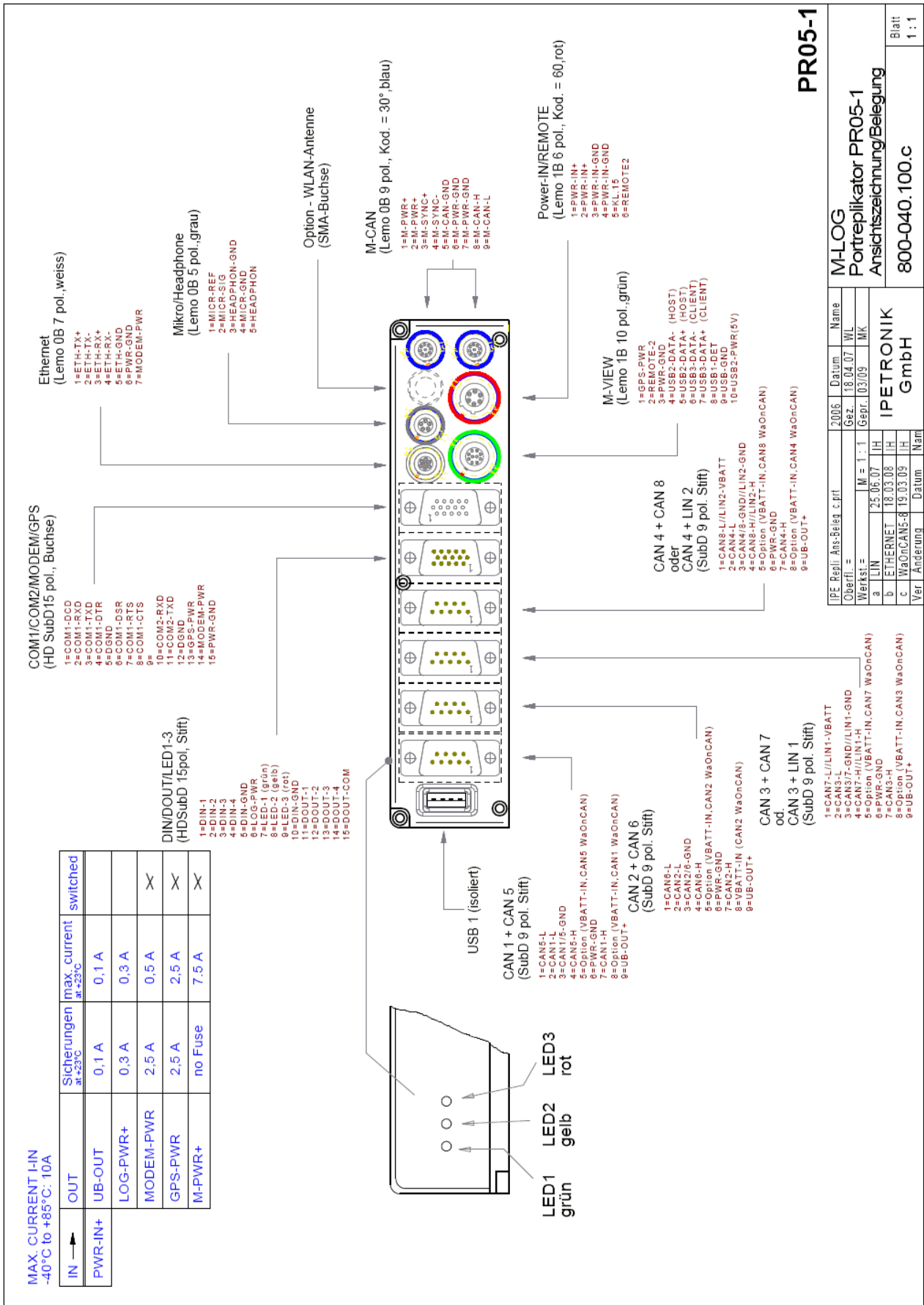

MAX. CURRENT I-IN
-40°C to +85°C: 10A

IN	OUT	Sicherungen	max. current	switched
PWR-IN+	UB-OUT	0.1 A	0.1 A	
	LOG-PWR+	0.3 A	0.3 A	
	MODEM-PWR	2.5 A	0.5 A	X
	GPS-PWR	2.5 A	2.5 A	X
	M-PWR+	no Fuse	7.5 A	X

PR05-1

MLOG
Portreplikator PR05-1
Ansichtszeichnung/Belegung
800-040.100.c

IPe Repl. Ans-Beleg c.prl	2006	Datum	Name
	18.04.07	WL	
Oberfl. =	Gez. =	03/09	MK
Werkst. =	M = 1 : 1		
a LIN	25.06.07	IH	
b ETHERNET	18.03.08	IH	
c WaOnCAN5-8	19.03.09	IH	
Ver / Änderung	Datum	Nam	

IPETRONIK GmbH

Blatt 1 : 1

Port replicator PR08 (4x Sub D 9, ETH, PWR-IN/REM Lemo 1B 6 pin) PIN assignment PR08

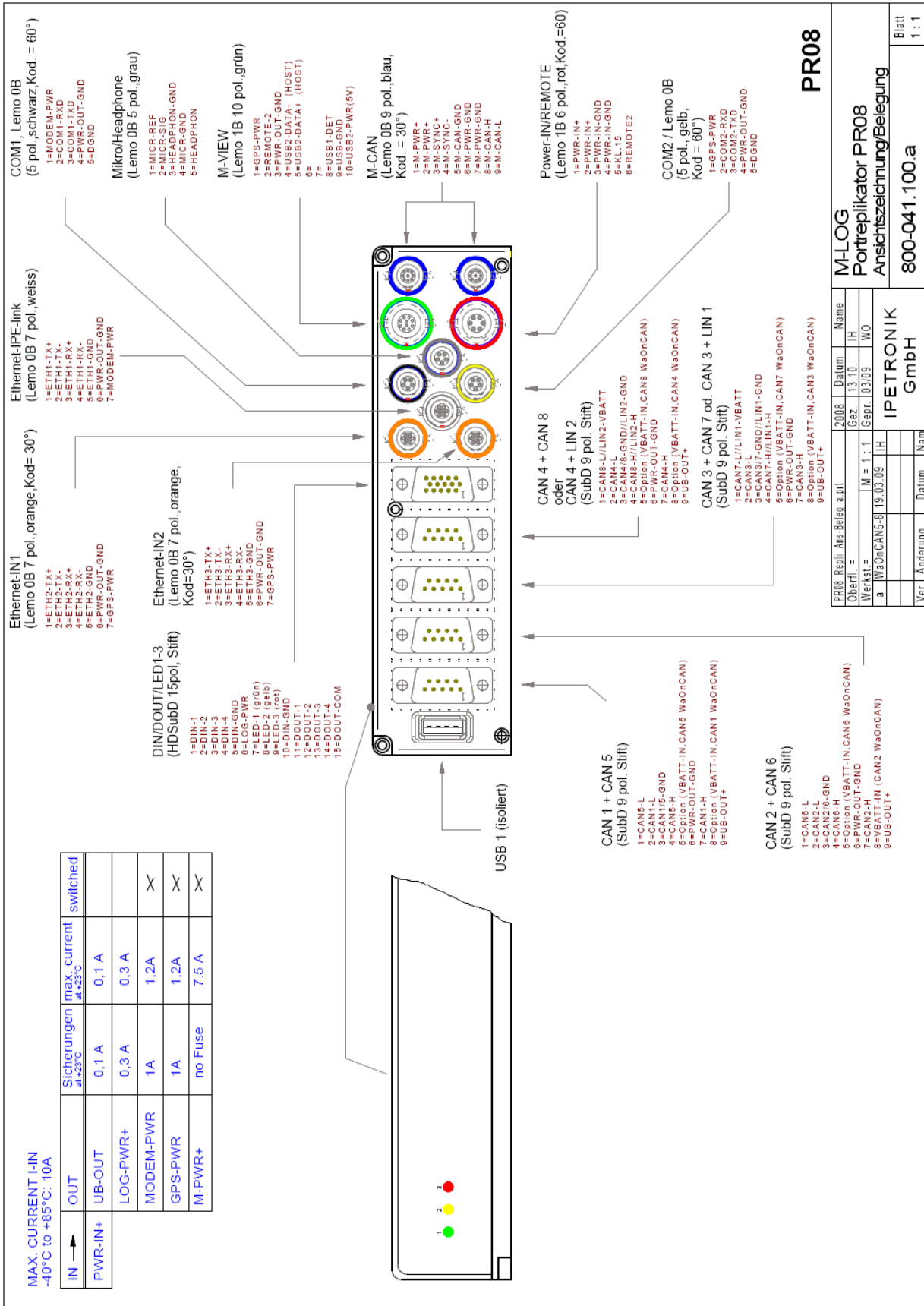

12.1.2 FLEETlog2-01

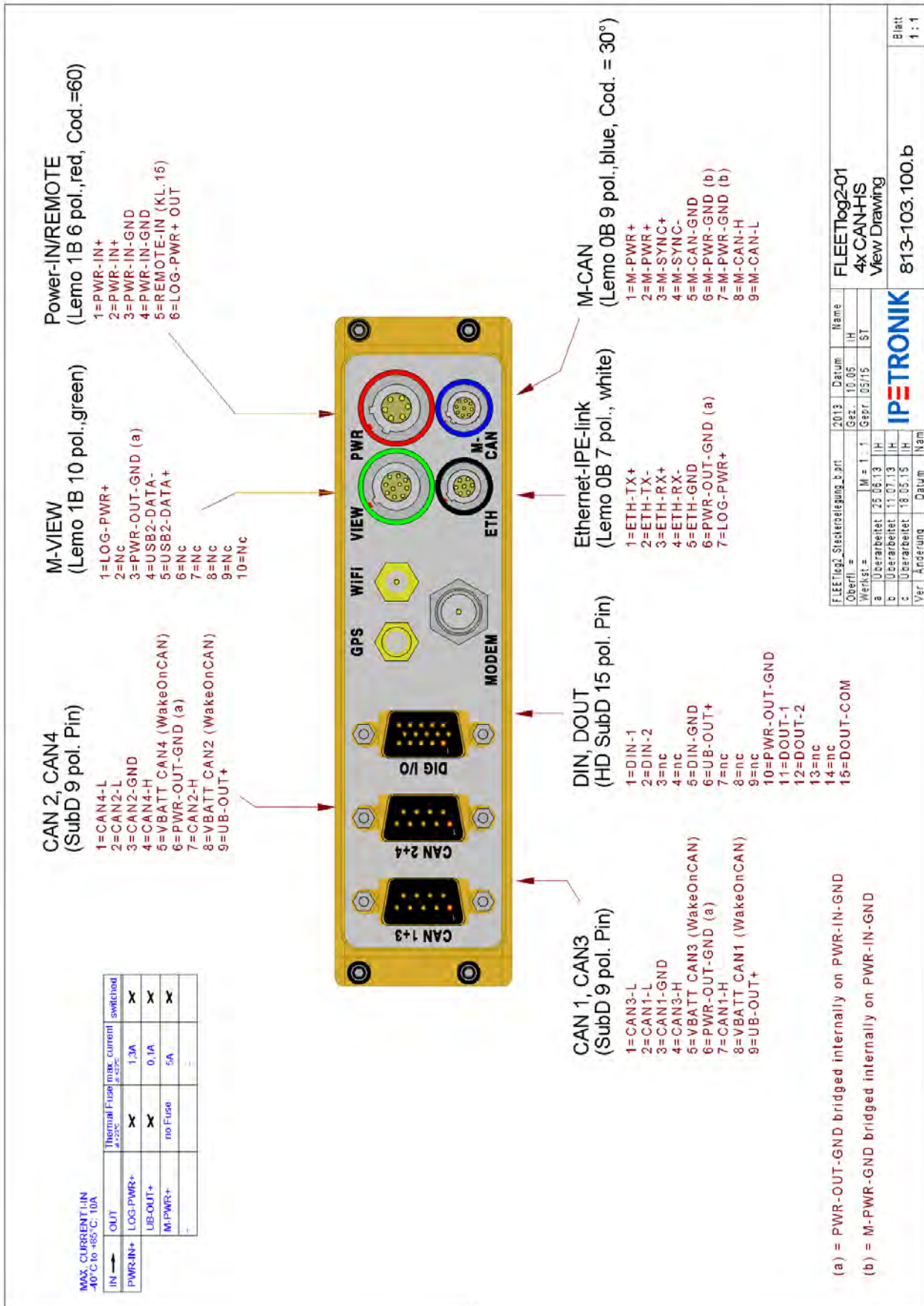

Ver. Änderung Datum Name

FLEETlog2_Steuerplatzelegung_2.ppt		2013	Datum	Name
Oberfl.	=	10.05	IH	
Werkst.	=	M = 1.1	ST	
a	Überarbeitet:	25.06.13	IH	
b	Überarbeitet:	11.07.13	IH	
c	Überarbeitet:	18.05.15	IH	

Ver. Änderung Datum Name

FLEETlog2-01				
4x CANHS				
View Drawing				
813-103.100.b				

(a) = PWR-OUT-GND bridged internally on PWR-IN-GND
 (b) = M-PWR-GND bridged internally on PWR-IN-GND

IN	OUT	Thermal Fuse @ 125°C	max. current @ 25°C	switched
PWR-IN+	LOG-PWR+	X	1.3A	X
UB-OUT+	M-PWR+	X	0.1A	X
		no Fuse	5A	X

12.1.3 FLEETlog2-03

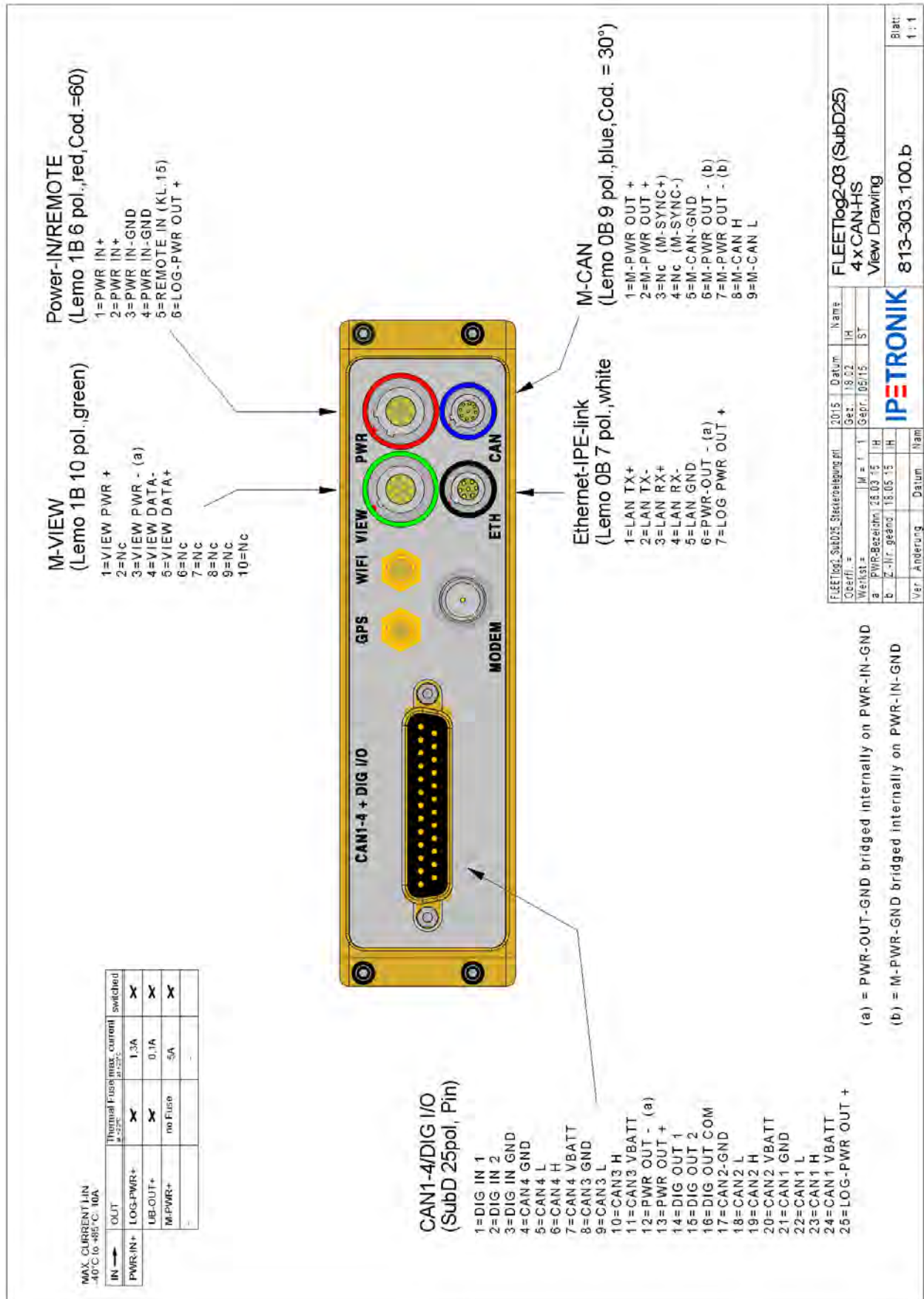

(a) = PWR-OUT-GND bridged internally on PWR-IN-GND
(b) = M-PWR-GND bridged internally on PWR-IN-GND

12.1.4 FLEETlog

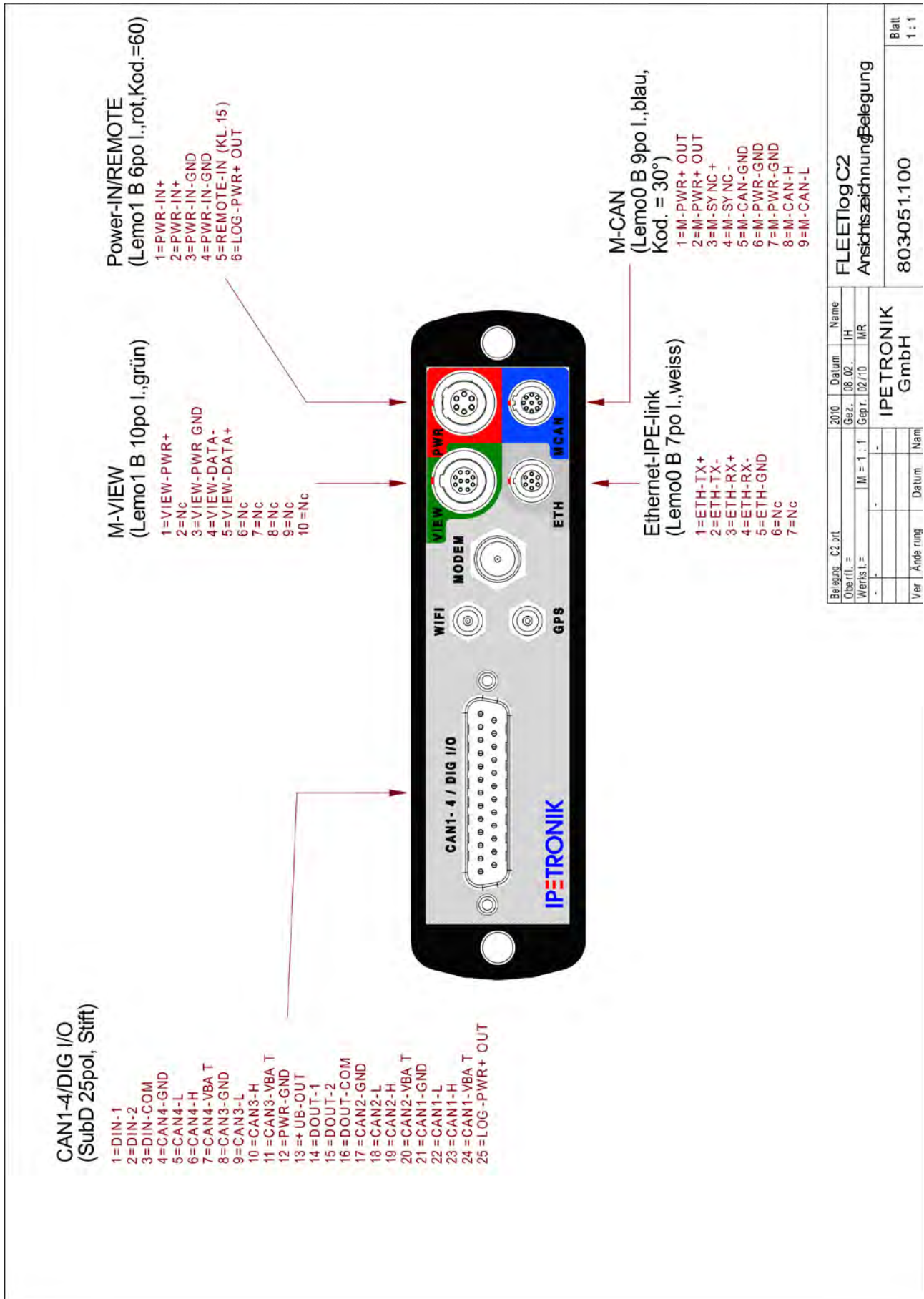

12.1.5 IPElog

MAX. CURRENT I-IN
-40°C to +85°C: 10A

IN →	OUT	Thermal Fuse at 123°C	max. current at 123°C	switched
PWR-IN+	LOG-PWR+	X	1.3A	X
	MODEM-PWR+	X	1.3A	X
	M-PWR+	no Fuse	5A	X
	ETH-PWR+	X	1.3A	X
	USB 1 PWR+	X	0.5A	X
	USB 2 PWR+	X	0.5A	X

M-CAN
(Lemo 0B 9 pol., blau, Kod. = 30°)

- 1=M-PWR*
- 2=M-PWR*
- 3=nc
- 4=nc
- 5=M-CAN1-GND
- 6=M-PWR-GND (c)
- 7=M-CAN1-H
- 8=M-CAN1-L

Ethernet-IPe-link
(Lemo 0B 7 pol., weiss)

- 1=ETH-link-TX+
- 2=ETH-link-TX-
- 3=ETH-link-RX+
- 4=ETH-link-RX-
- 5=ETH-link-GND
- 6=PWR-OUT-GND (b)
- 7=MODEM-PWR*

Ethernet-IN1
(Lemo 0B 7 pol., orange, Kod.= 30°)

- 1=ETH1-TX+
- 2=ETH1-TX-
- 3=ETH1-RX+
- 4=ETH1-RX-
- 5=ETH1-GND
- 6=PWR-OUT-GND (b)
- 7=ETH1-PWR*

M-VIEW
(Lemo 1B 10 pol., grün)

- 1=LOG-PWR*
- 2=PWR-OUT-GND (b)
- 3=USB2-DATA+
- 4=USB2-DATA-
- 5=USB2-GND (a)
- 6=nc
- 7=nc
- 8=nc
- 9=USB-GND (a)
- 10=USB2-PWR* (5V)

USB 2
(Lemo 1B 5 pol., grau)

- 1=USB2-PWR*
- 2=USB2-DATA+
- 3=USB2-DATA-
- 4=SHIELD
- 5=USB-GND (a)

Ethernet-IN2
(Lemo 0B 7 pol., orange, Kod.=30°)

- 1=ETH2-TX+
- 2=ETH2-TX-
- 3=ETH2-RX+
- 4=ETH2-RX-
- 5=ETH2-GND
- 6=PWR-OUT-GND (b)
- 7=ETH2-PWR*

DINDOUT/LED1-3
(HDSUBD 15pol. Stift)

- 1=DIN-1
- 2=DIN-2
- 3=DIN-3
- 4=DIN-4
- 5=DIN-GND (d)
- 6=LOG-PWR1
- 7=LED-1 (0/0/0)
- 8=LED-2 (0/0/0)
- 9=LED-3 (0/0/0)
- 10=DIN-GND (d)
- 11=DDOUT-1
- 12=DDOUT-2
- 13=DDOUT-3
- 14=DDOUT-4
- 15=DDOUT-GND

CAN 1... CAN6 + CAN 7... CAN12
(SubD 9 pol. Stift)

- 1=CAN7-L CAN12L
- 2=CAN1-L CAN6-L
- 3=CAN7-GND CAN6-GND
- 4=CAN7-H CAN72-H
- 5=nc
- 6=CAN7-GND CAN12-GND
- 7=CAN1-H CAN6-H
- 8=nc
- 9=nc

CAN 1... CAN6 + CAN 7... CAN12
(SubD 9 pol. Stift)

- 1=CAN7-L CAN12L
- 2=CAN1-L CAN6-L
- 3=CAN7-GND CAN6-GND
- 4=CAN7-H CAN72-H
- 5=nc
- 6=CAN7-GND CAN12-GND
- 7=CAN1-H CAN6-H
- 8=nc
- 9=nc

(a) = USB-GND intern auf PWR-IN-GND gedrückt
 (b) = PWR-OUT-GND intern auf PWR-IN-GND gedrückt
 (c) = M-PWR-GND intern auf PWR-IN-GND gedrückt
 (d) = DIN-GND intern auf PWR-IN-GND gedrückt

IPeLog_CJ_Ans-Baugr.cprt	2012	Datum	Name
Gez.	12.10.	IH	
Gedr.	04/13	MR	

IPETRONIK GmbH

IPElog
Ausführung C1
Belegung

809-003.101.b

Blatt	1 : 1
-------	-------

12.1.6 IPElog2-01 (16 CAN)

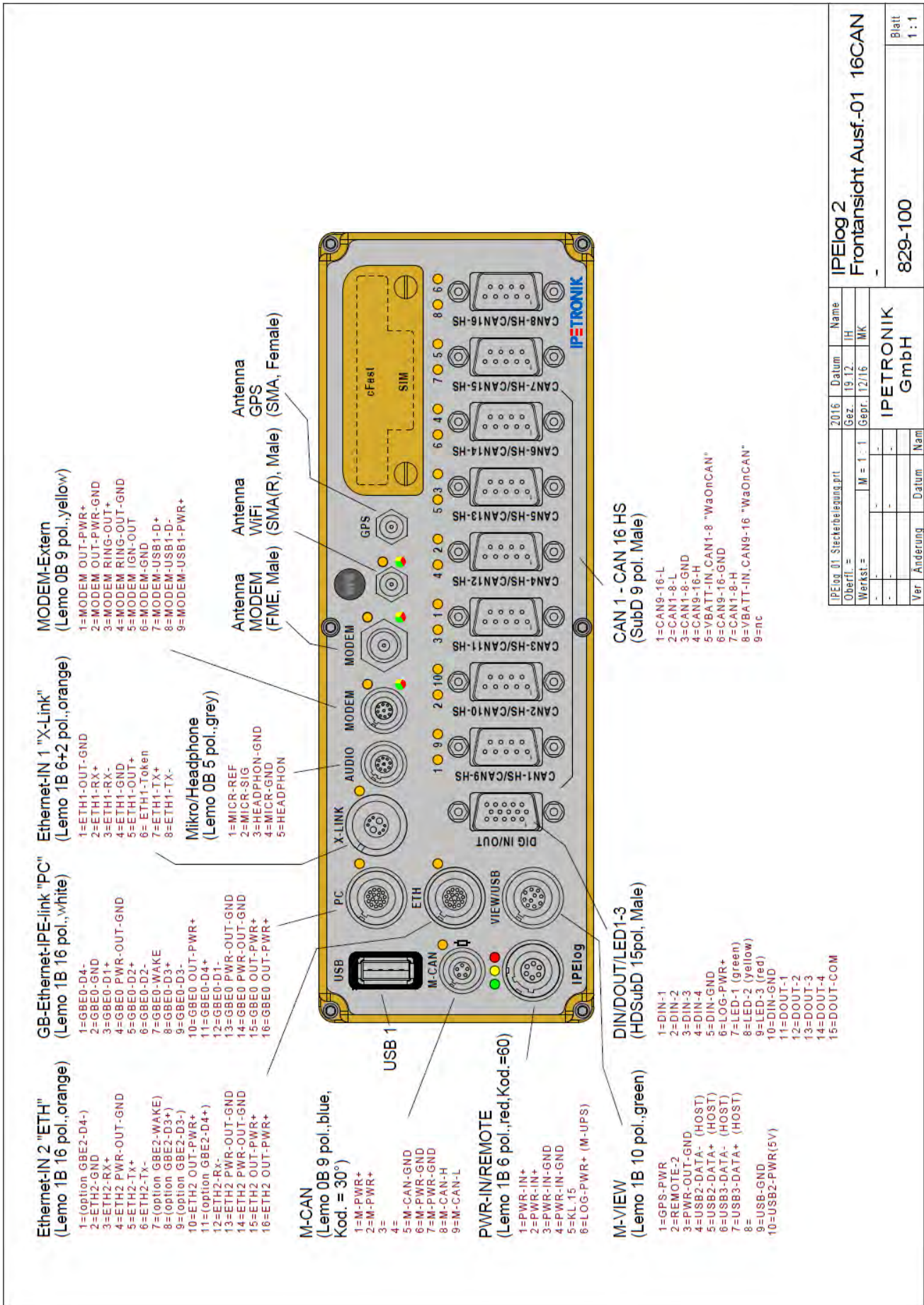

IPElog 01 Steckerbelegung.gri		2016	Datum	Name
Oberfl. =	Gez. =	19.12.	IH	
Wertst. =	M = 1 : 1	Gepr. 12/16	MK	
Ver. Änderung	Datum	Nam		
			IPETRONIK GmbH	
			IPElog 2 Frontansicht Ausf.-01 16CAN	
			829-100	
			Blatt 1 : 1	

12.1.7 IPElog2-02 (10 CAN, 6 LIN)

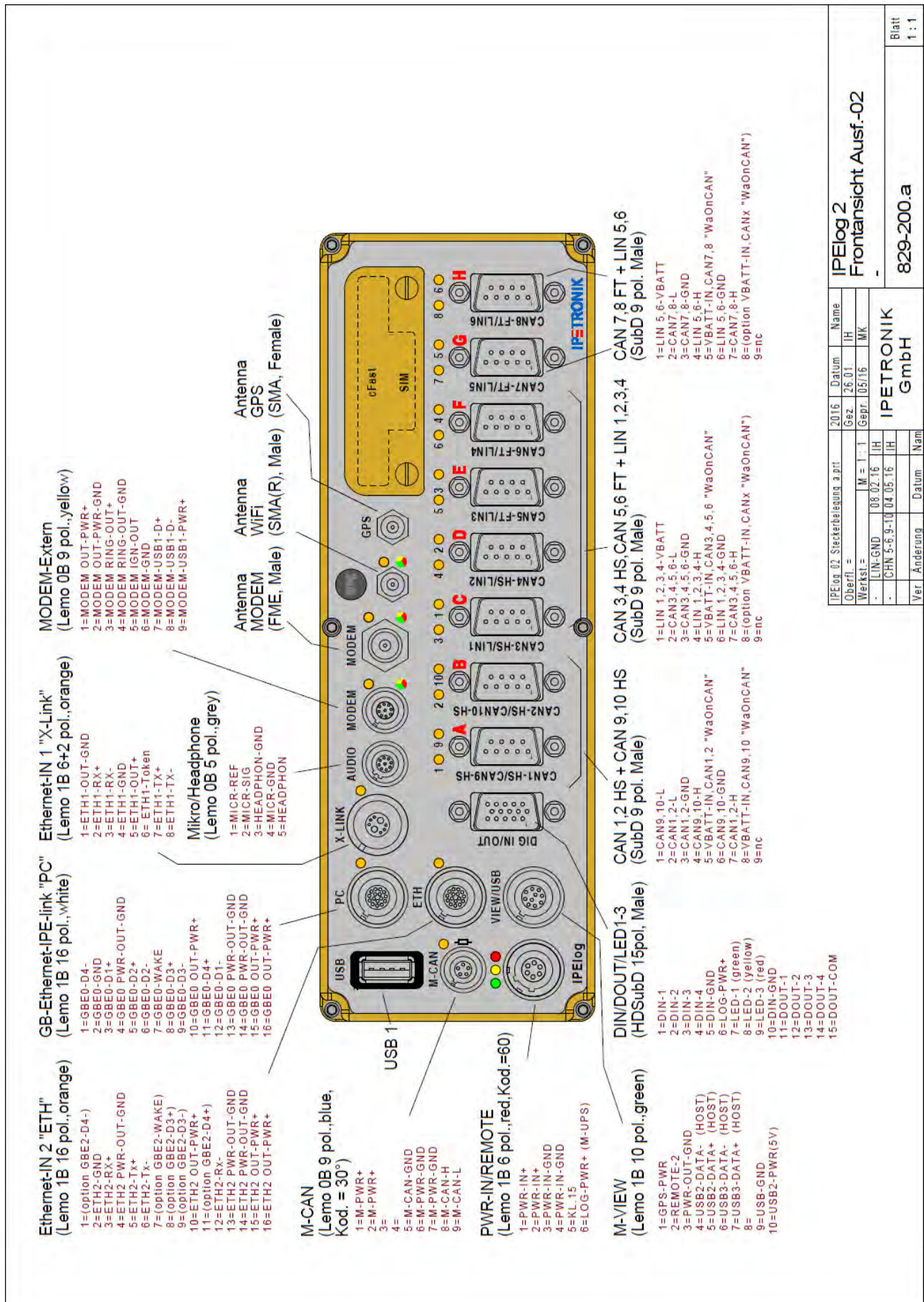

IPElog 02 Systerbaesqu a prt		2016	Datum	Name
Oberfl =	M = 1	1	26.01	IH
Werkstl =	CHN 5-6-9-10	08.07.16	05/16	MK
Ver	Änderung	Datum	Name	
			IPETRONIK GmbH	
IPElog 2 Frontansicht Ausf.-02			Blatt 1:1	
829-200.a				

12.2 Starting up

12.2.1 Overview Configuration & Measurement

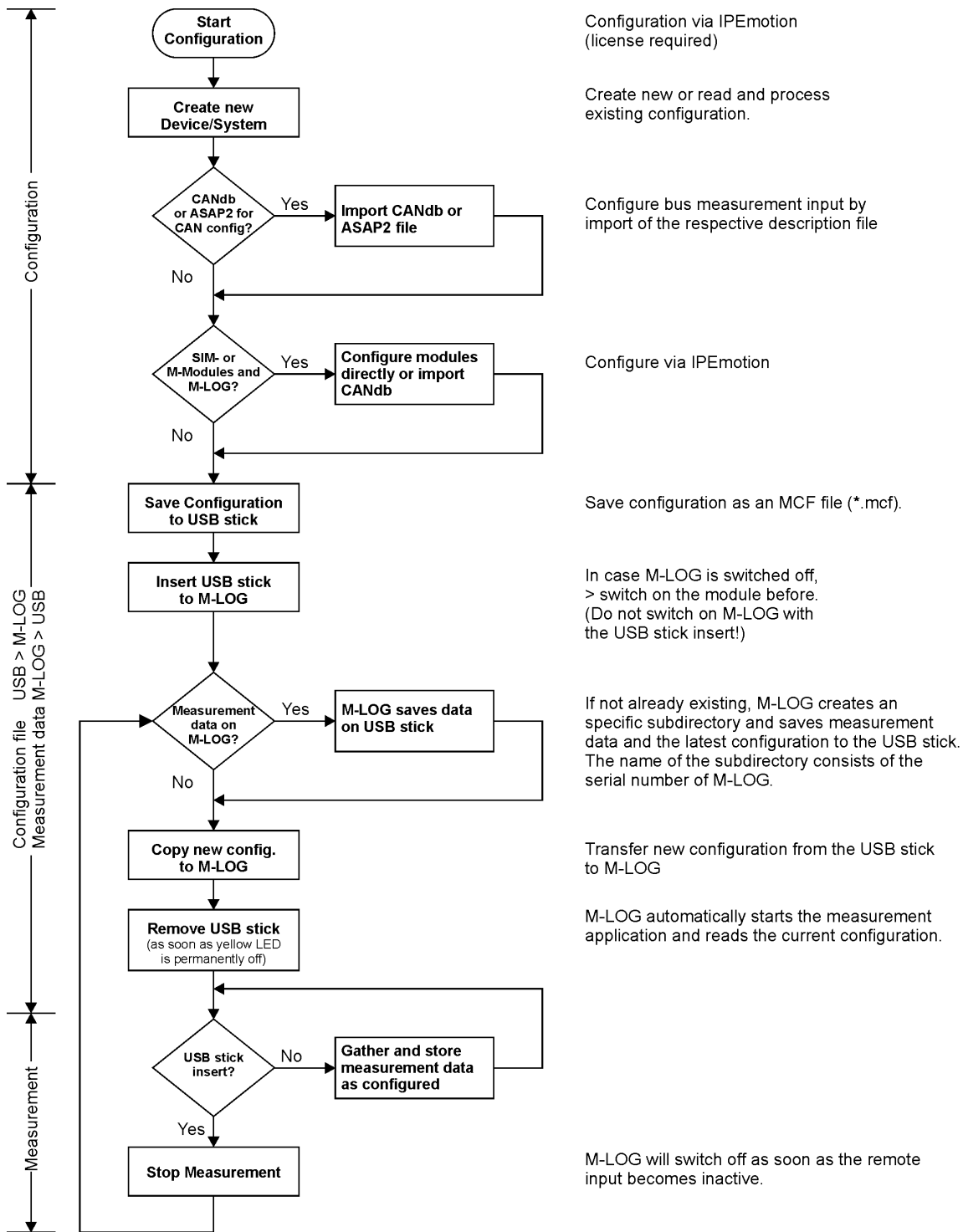

12.3 Practical examples

12.3.1 Calculating memory footprint

The memory footprint per storage group results from the following data

- ▶ Memory footprint of acquisition channels +
- ▶ Memory footprint of time channel (relative and absolute time channel) +
- ▶ Memory footprint of header (description file)

Memory footprint of acquisition channels

Acqu. duration [s] x storage rate [1/s] x channel count x 2 Byte = memory footprint in Byte

Memory footprint in Byte / 1024 = memory footprint in kByte

Memory footprint of time channel (IPE:Clock = relative time channel)

Acqu. duration [s] x storage rate [1/s] x 4 Byte = memory footprint in Byte

Memory footprint in Byte / 1024 = memory footprint in kByte

Do not mix the time channel (relative) with the time stamp channel (absolute = Date, time). The time stamp channel is only recorded if activated in storage group dialog.

Memory footprint of header file

The memory footprint of the header file depends on the size of acquisition configuration (channel count, sampling rate, different data formats, ...) and cannot be defined by a general formula. The size of the header file is usually much smaller so that it can be neglected. Exceptions are short acquisitions or acquisitions with many channels at low storage rate (< 1 Hz).

12.3.2 Linear signal scaling

The conversion of a raw value (binary value, e.g. in a CAN message) into a physical value (value with unit) is effected with the scaling. IPETRONIK offers the scaling calculator and supports linear scaling with the line equation as factor/offset or 2 point scaling.

The scaling of a voltage or current signal (sensor output) into a corresponding physical or percentage value is effected in the same way. The following examples show the connections.

Mathematical basics for the linear equation

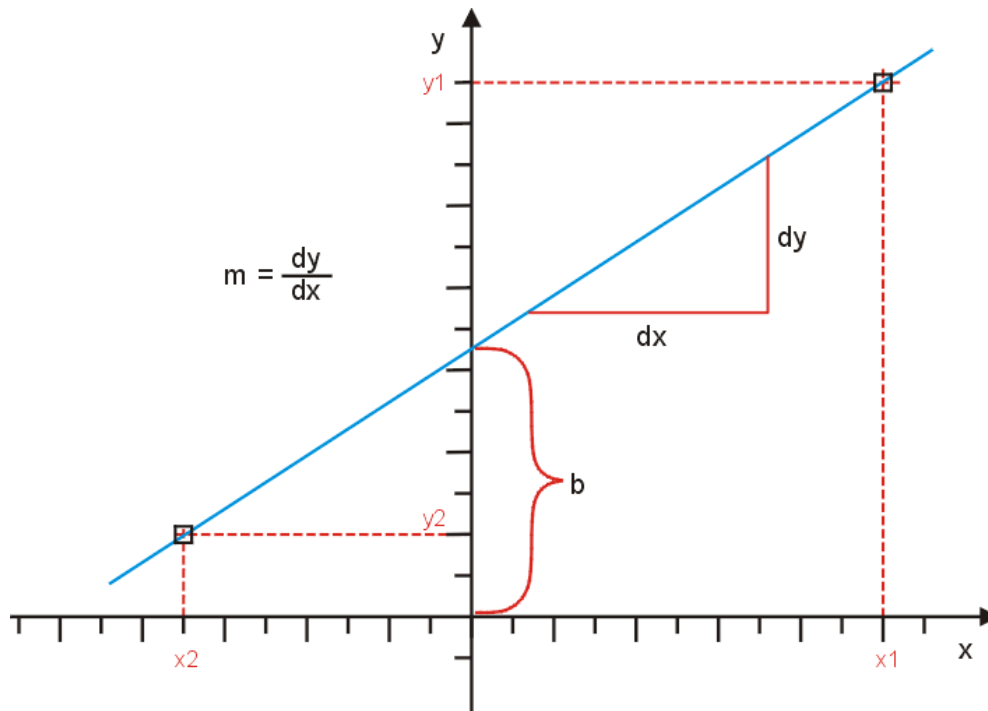

Point gradient form

$$y = m * x + b$$

$$b = y - m * x$$

m = Gradient (gain)

b = constant (offset)

Two points form

$$m = dy / dx$$

$$m = (y1 - y2) / (x1 - x2)$$

m = Gradient (gain)

Calculation and explanation

1. The linear equation $y = m * x + b$ shows the mathematical connection.
2. Calculate the m gradient within any input range (signal) and the related output range (physical value).
3. Calculate the offset b by using the x and y values for a known point.
4. Calculate, if required, further y values by using the corresponding x values and the equation, e.g. for calculating the physical values for another input range (Channel min, max).

Example pressure sensor

A pressure sensor has an output signal of -0.5 to 4.5 V in the acquisition range 0 ... 20 bar. The voltage signal is converted to the physical value with the linear scaling.

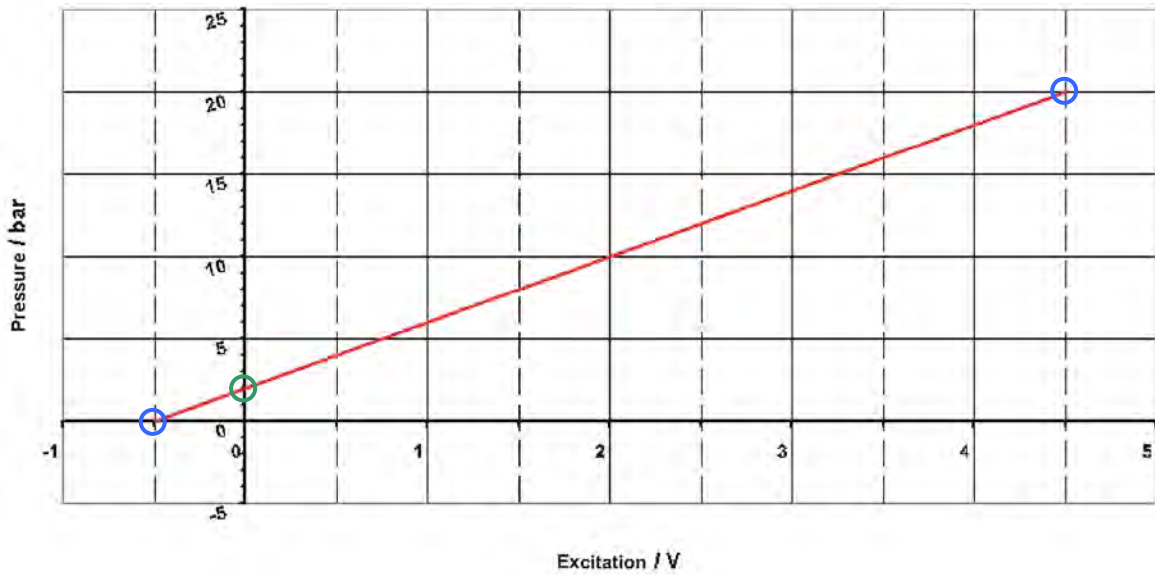

x1	x2	y1	y2	m	b'	b
4.5	-0.5	20	0	4	2	2

Example CAN raw value in the Word unsigned format als temperature

A temperature signal is a CAN message in the Word unsigned format. The value range of 0... 65535 (16 Bit) corresponds to a temperature range of -50 °C ... +200 °C.



Please note that the output range has an offset of -50 °C. This must be respected at calculating: (b' = Offset without output offset, b = Offset + output offset).

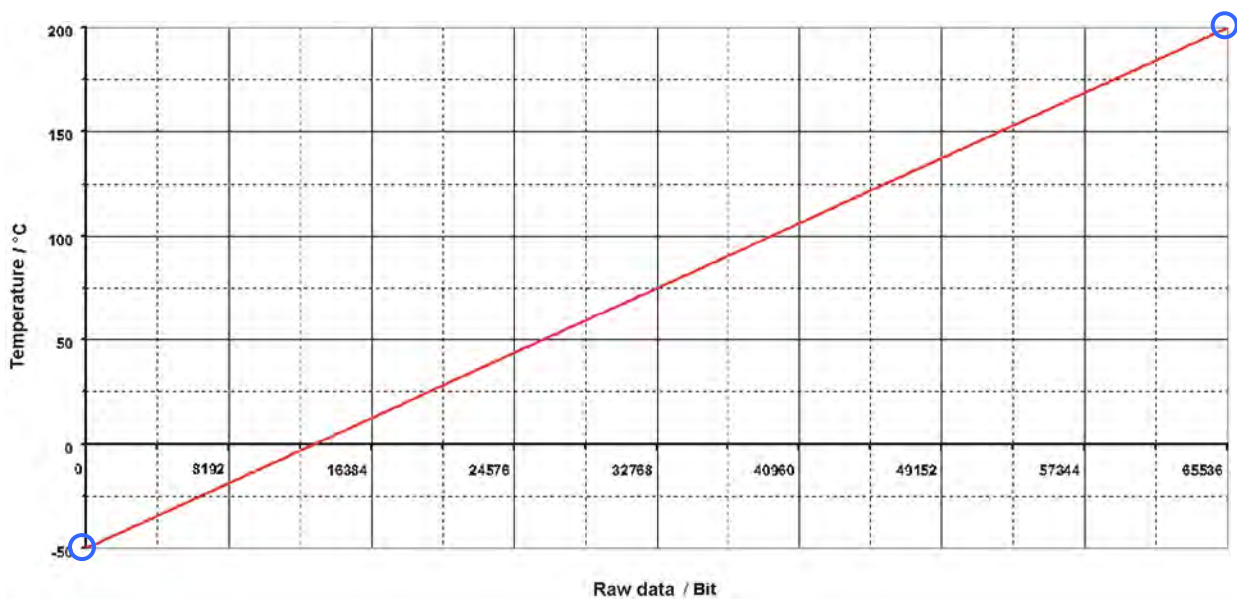

x1	x2	y1	y2	m	b'	b
65535	0	200	-50	0.0038147	0	-50

Example CAN raw value in the Word signed format as temperature

A temperature signal is a CAN message in the Word signed format. The value range of -32768... 0 ... 32767 (16 Bit) corresponds to a temperature range of -50 °C ... +200 °C.



Please note that the output range has an offset of -50 °C. This must be respected at calculating: (b' = Offset without output offset, b = Offset + output offset).

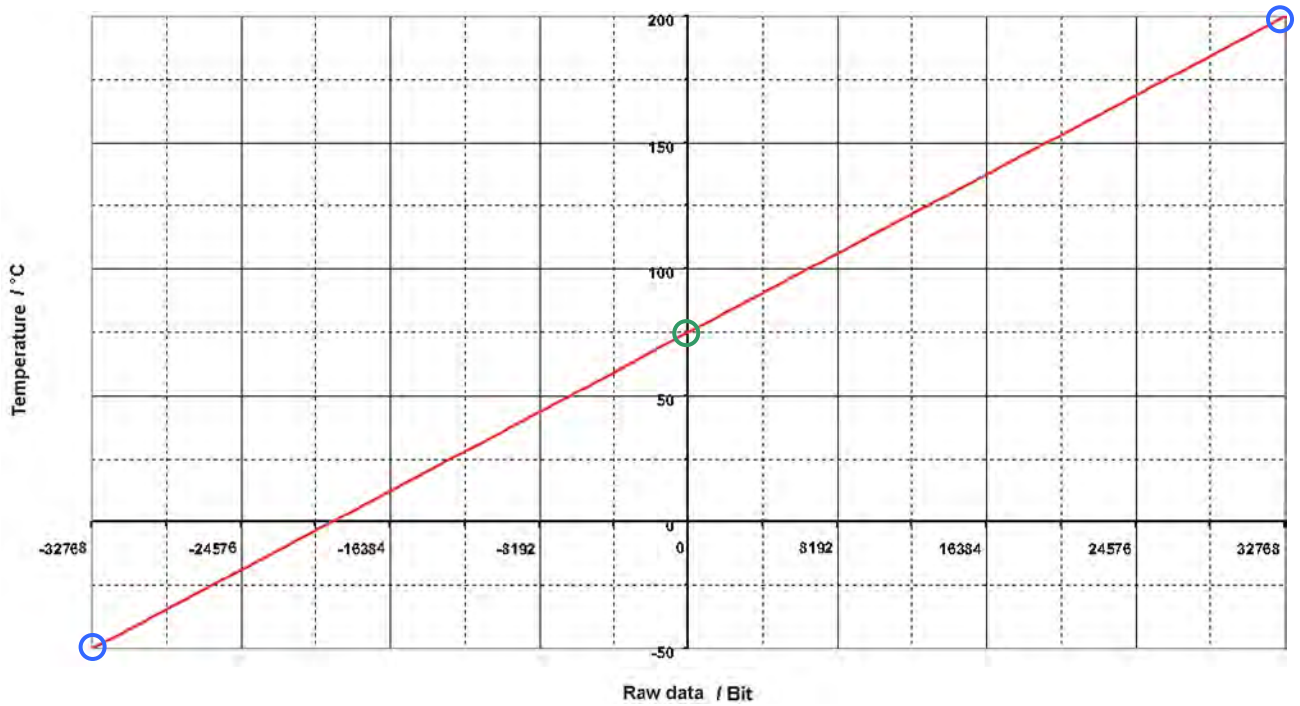

x1	x2	y1	y2	m	b'	b
32767	-32768	200	-50	0.0038147	125.0019	75.0019

12.4 Status messages

12.4.1 Most important status messages

Following message types are defined:

I Information W Warning E Error D Debug

Type number: xxx-xxx-xxxx

Number corresponds to the number of the type plate of M-LOG (entry in hw_descr.xml).

Wait max. 3min for write permission (power good)

M-LOG waits until CAPs are loaded (status message "Power good" from PIC). If status is "Power good", data is written to flash. If this status is not reached, (PIC) switches off M-LOG after 3 min.

Power good

Message (from PIC) that CAPs are loaded.

Debounce remote signal 1000 ms

Remote signal must be on at least for 1 s to reach "ON" status. (Debouncing of remote signal)

Remote signal is detected as such if excitation > 6.5 V at PIN terminal:15 of PWR-IN/REM socket.

Watchdog active

PIC transfers control of M-LOG to TESTdrive.

Function: Testdrive cyclically describes a storage range in Powermanagement (PIC) (toggling bit). If this toggling fails for more than two minutes, M-LOG is switched off by Powermanagement (PIC).

Free disk space: xxx/xxx

Indicates the available total memory space. TestDrive 3.09 shows a "Free disk space: xxxx" at the left bottom display window. It shows the available space for data storage (40% of total memory space). Initially, this value fluctuates intensively but stabilizes with a longer acquisition because it is recalculated permanently.

Time left: xx xx:xx:xx

Display bottom left in monitor window. Meaning: d hh:mm:ss

Power bad

If excitation is too low, status is "Power bad".

Info: This message is not concerned with CAPs contrary to "Power good" message.

Can't initialize communication mediums

Dev_conf.xml is not included in Config, i.e. no data transfer activated.

Shutdown in 55 min

If data postprocessing (zipping, establishing, data transferring, data sending, etc.) is not completed within 55 min, Testdrive shuts down and data remains on logger.

Emergency shutdown in 60 min

Logger is unconditionally shut down after 60 min. Powermanagement of M-LOG controls the device.

Time left: xx xx:xx:xx

Display bottom left in monitor window. Meaning: d hh:mm:ss

Power bad

If excitation is too low, status is "Power bad".

Info: This message is not concerned with CAPs contrary to "Power good" message.

Can't initialize communication mediums

Dev_conf.xml is not included in Config, i.e. no data transfer activated.

Shutdown in 55 min

If data postprocessing (zipping, establishing, data transferring, data sending, etc.) is not completed within 55 min, Testdrive shuts down and data remains on logger.

Emergency shutdown in 60 min

Logger is unconditionally shut down after 60 min. Powermanagement of M-LOG controls the device.

12.4.2 Warning and error messages after program update**Program options without license**

TESTdrive Version 3.17 includes a license software to check the use of logger / TESTdrive options. This requires sending new license keys to the logger.

After a TESTdrive program update, potential warning messages can indicate locked options. TESTdrive checks if used functions are really unlocked on the logger. Following warning is written into log file if e.g. all inputs of a card with 4 CAN inputs is used but only 2 are unlocked.

01.04.2009 14:11:45 W CAN1 : Upper limit of licenced CAN interfaces reached. Max= 2

Please contact the sales team at +49 7221 / 9922 – 222 to assist you with warning and error messages, as well as, licensing.



TESTdrive V03.22 deactivates the non-licensed functionality and warns with the red status LED (temporarily at acquisition start). Depending on the missing license, acquisitions are limited (e.g. possible calculations but no classification) or disabled (e.g. at missing license for interface).

If an extender is used at the logger, an additional license for the extender is required!

The system shows the following warning if an extender is used with a non-licensed CCP protocol:

16.02.2011 15:36:01 E Extender.80200011: Error reading XML-Buffer at line 11

12.5 Description of TESTdrive files

TESTdrive provides the measurement files as zip archives. TESTdrive creates separate zip files for every acquisition:

MEA_XXXX.zip (Acquisition data + header file + current configuration)

LOG_XXXX.zip (Protocol file for data acquisition)

A data set of an acquisition always includes a header file (AABBCCC.DAT), at least one acquisition file in DIAdem format, as well as, the corresponding acquisition configuration (e.g. IPEmotion.isf).

The names of the single acquisition files are generated according to the **AABBCCC.DDD** structure:

AA	=	Data type
BB	=	Consecutive number allocated based on all data types used with the configuration
CCCC	=	Consecutive number of an acquisition
DDD	=	File extension

AA data type indicates the type of data:

DO	=	Data Online (storage group with time channel)
PM	=	Post Mortem data of a ring buffer group (storage group with time channel)
CO	=	(C) Classification Online (storage group with statistic data, without time reference)
A0	=	Audio Online
V0	=	Video Online
J	=	Job data = Diagnostic data
ST	=	Min-Max list
TBQS, T	=	CAN/LIN traffic acquisition (during or after boot process)
MV	=	Maneuver recording

The consecutive **BB** number clearly assigns data within one data type. Several storage groups for instance can be detected with real-time data, which are distinguished from each other by this number.

The consecutive **CCCC** number differentiates between single acquisitions. Each acquisition is therefore clearly defined.

The **DDD** file extension defines the data format as follows:

DAT	=	DIAdem header file
T64	=	DIAdem time channel with 64 bit resolution
W8	=	DIAdem data with 8 bit unsigned (BYTE)
W16	=	DIAdem data with 16 bit unsigned (WORD)
W32	=	DIAdem data with 32 bit unsigned (WORD)
I16	=	DIAdem data with 16 bit signed (INTEGER)
I32	=	DIAdem data with 32 bit signed (INTEGER)
R32	=	DIAdem data with 32 bit in floating point displaying (REAL)
R64	=	DIAdem data with 64 bit in floating point displaying (REAL)
WAV	=	Audio file in WAV format
AVI	=	Video file in AVI format
CSV	=	Comma Separated Values
Jxx	=	Binary file with job result

After reaching the consecutive file number 9999 (CCCC), counting starts again with 0001!

If the file with this number still exists, it is overwritten with new data!

Recorded signals are divided into different files accordingly to data type, i.e. all 8 bit signals unsigned are in a *.W8 file, all 32 bit signals signed in a *.I32 file, etc.

Important advices:

TESTdrive defines the number of the storage group during the initialization process. An assignment of the storage group number to the order in the configuration interface is not given.

All information of a storage group is stored in the DAT file. The DAT file has a 8 bit ASCII format (ANSI code page 1252, ISO 8859-1).

The storage group name can be defined with IPEmotion and is also stored in the DAT file.

All project information are stored in the DAT file (vehicle no., project name, etc.). At working with classifications, the DAT file contains additional fields to define the classification in detail.

12.5.1 Data types

Time-related data (Storage group)

The header file and the corresponding data files are created for every storage group (= signals with common storage rate).

Example (Acquisition no. 699 > DOBBCCCC.DDD)

Storage group 1	DO010699.DAT	Header
	DO010699.R32	32 Bit (Real)
	DO010699.W16	16 Bit (Word unsigned)
	DO010699.W32	32 Bit (Word unsigned)
Storage group 2	DO020699.DAT	Header
	DO020699.W8	8 Bit (Byte unsigned)
	DO020699.W32	32 Bit (Word unsigned)
Storage group x	DO0x0699.DAT	Header
	DO0x0699.W8	16 Bit (Word unsigned)

Statistics

TESTdrive saves classification data in DIAdem format, which includes all parameters in one header file. This header file includes additional information about classification description. Corresponding to the storage groups and the general DIAdem conventions, binary data is included in the same files. These files are separated accordingly to data type and are defined by an extension corresponding to data type, e.g. *.W32, *.R64.

The results of several classifications of the same data type are stored in one binary file. Most classification types create results of the W32 data type. The retention time classification can create different data types.

Example (Acquisition no. 699 > COBBCCCC.DDD)

Header	CO010699.DAT	Header
Classification m ... n	CO010699.W32	32 Bit (Word unsigned), can include several classifications
	CO010699.R64	64 Bit (Real), can include several classifications

Audio recording

A DIAdem acquisition and one or several audio files (WAV format) are created with an audio recording.

The DIAdem acquisition contains the trigger event, the WAV file includes the audio data.

Every audio file is assigned to one triggering event. The names of the audio files include the counter value of the trigger channel to create a direct reference within the acquisition data. The respective audio file is recorded for the time of an activated trigger.

Example DIAdem file (Acquisition no. 699 > A000CCCC.DDD)

Trigger channel	A0000699.DAT	Header
	A0000699.W16	16 Bit (Word unsigned)

Example audio file (Acquisition no. 699 > ABBBCCCC.WAV)

Audio sequence 1	A0010699.WAV	Audio data of 1. trigger event
Audio sequence 2	A0020699.WAV	Audio data of 2. trigger event
Audio sequence x	A00x0699.WAV	Audio data of 3. trigger event

Video recording

A DIAdem acquisition and one or several video files (JPG = single image or AVI = video sequence) are created with an video recording.

The DIAdem acquisition contains the trigger event, the JPG or AVI file includes the video data.

Every video file is assigned to one triggering event. The names of the video files include the counter value of the trigger channel to create a direct reference within the acquisition data. The respective video file is recorded for the time of an activated trigger. Exactly one single image is saved per trigger event, independent of the trigger duration.

Example DIAdem file (Acquisition no. 699 > V000CCCC.DDD)

Trigger channel 1 (Video)	V0000699.DAT	Header
	V0000699.W16	16 Bit (Word unsigned)

or

Trigger channel 1 (Image)	I0000699.DAT	Header
	I0000699.W16	16 Bit (Word unsigned)

Example video file (Acquisition no. 699 > VBBBCCCC.AVI)

Video sequence 1	V0010699.AVI	Video data
Video sequence 2	V0020699.AVI	Video data

or

Image 1	I0010699.JPG	Image data
Image 2	I0020699.JPG	Image data

Diagnostic acquisition

Error memory and non-recurring data

TESTdrive creates additional files for error memory and non-recurring data. This CSV file (BDJDcccc.CSV) is an overview and includes all information about the completed jobs. Every successful job is saved in a binary file (BDS1cccc.Jxx), which contains the actual data.

A CSV file**, as well as, the corresponding jobs are created after the completed acquisition of UDS services.

**** A CSV file is only created in binary mode, not in trace modeT.**

The names of the single acquisition files are generated according to **BDPECCCC.DZZ** structure:

BDPECCCC.DZZ	with P = U (UDS protocol), P = K (KWP protocol)
BDPECCCC.DZZ	with E = ECU number (1 ... 9)
BDPECCCC.DZZ	with D = J (Job or binary file), D = T (Trace file)
BDPECCCC.DZZ	with ZZ = Job number (01 ... 99)

Example non-recurring data (Acquisition no. 699 > BDPECCCC.DZZ)

Trace file	BDU10699.T01	UDS protocol, ECU no. 1, Acquisition no. 699, Job no. 1
Binary file	BDU10699.J01	UDS protocol, ECU no. 1, Acquisition no. 699, Job no. 1
CSV file	BDJD0699.CSV	Job overview of binary files

Measurement status file

Measurement status file in XML format offers information about the process of a completed acquisition. This includes:

- Acquisition start and stop (... in standardized XML format "DateTime")
- General system information (hardware, TESTdrive version,...)
- Storage group trigger
- Acquisition / Diagnosis information
- Limit violations
- Maneuver detection

Measurement status file is created after acquisition stop and is stored in the zip container of the acquisition (MEA_xxxx.zip) or attached to the status e-mail if this file creation has previously been activated in IPEmotion **Options > PlugIns > IPETRONIK LOG > PlugIn specific settings > Options > General > Create measurement status file.**

Example Measurement status file (measurement number 699 > MSxxyyyy.xml)

xx = Append number, yyyy = Measurement number

Measurement status file 1	MS010699.xml
Measurement status file 2	MS020699.xml

If an acquisition is later continued (Append mode), TESTdrive increases the append number in the file name.

Min-Max list (STG file)

TESTdrive creates a separate statistic file (STG file) to record minimum and maximum values as well as first and last valid value of selected signals. The STG file is created at the end of each measurement, if the **Logger processing** contains a **Statistic group** containing at least one channel. The statistic file is stored in the zip container of the acquisition (MEA_xxxx.zip)

Example STG file (Acquisition no. 699 > STBBCCCC.STG)

STG file 1	ST010699.STG	Min / Max data of storage / process group 1
STG file 2	ST020699.STG	Min / Max data of storage / process group 2

Traffic recording (CAN, LIN)

TESTdrive saves traffic acquisitions in binary format. A traffic acquisition can include two binary files:

- Traffic data recorded by TESTdrive during boot time
- Traffic data recorded by TESTdrive during run time

Advice: Storage of CAN traffic data and LIN traffic data in the same file

The names of the single acquisition files are generated according to **TBBBCCCC.BIN** structure:

TBBBCCCC.BIN	Traffic data recorded by TESTdrive
TBBBCCCC.BIN	Consecutive number within an acquisition
TBQSCCCC.BIN	Traffic data recorded by micro controller

Maneuver recording

TESTdrive creates a file in ASCII format for maneuver recordings.

The maneuver file functions like a storage group, i.e. the file receives a consecutive number within the acquisition.

The names of the single acquisition files are generated according to **MVBBCCCC.ASC** structure:

MVBBCCCC.ASC	Name of respective storage group
---------------------	----------------------------------

Example (Acquisition no. 699 > MVBBCCCC.ASC)

Storage group 1	DO010699.DAT	Header
	DO010699.I16	16 Bit (Integer signed)
Storage group 2	DO020699.DAT	Header
	DO020699.R32	32 Bit (Real)
Maneuver file	MV030699.ASC	